

User Manual

Tektronix

**TDS 620A, 640A & 644A
Digitizing Oscilloscopes**

070-8715-04

Copyright © Tektronix, Inc., 1993. All rights reserved.

Tektronix products are covered by U.S. and foreign patents, issued and pending. Information in this publication supercedes that in all previously published material. Specifications and price change privileges reserved.

Printed in the U.S.A.

Tektronix, Inc., P.O. Box 1000, Wilsonville, OR 97070-1000

TEKTRONIX, TEK, TEKPROBE, and SCOPE-MOBILE are registered trademarks of Tektronix, Inc.

Microsoft is a registered trademark of Microsoft Corporation.

IBM is a registered trademark of International Business Machines.

GPIB-PCII and GPIB-PCIIA are registered trademarks of National Instruments Corporation.

Epson is a registered trademark of Epson America, Inc.

Interleaf is a trademark of Interleaf, Inc.

PostScript is a registered trademark of Adobe Systems Incorporated.

Deskjet, Laserjet, and Thinkjet are registered trademarks of Hewlett-Packard Corporation.

WARRANTY

Tektronix warrants that the products that it manufactures and sells will be free from defects in materials and workmanship for a period of three (3) years from the date of shipment. If a product proves defective during this warranty period, Tektronix, at its option, either will repair the defective product without charge for parts and labor, or will provide a replacement in exchange for the defective product.

In order to obtain service under this warranty, Customer must notify Tektronix of the defect before the expiration of the warranty period and make suitable arrangements for the performance of service. Customer shall be responsible for packaging and shipping the defective product to the service center designated by Tektronix, with shipping charges prepaid. Tektronix shall pay for the return of the product to Customer if the shipment is to a location within the country in which the Tektronix service center is located. Customer shall be responsible for paying all shipping charges, duties, taxes, and any other charges for products returned to any other locations.

This warranty shall not apply to any defect, failure or damage caused by improper use or improper or inadequate maintenance and care. Tektronix shall not be obligated to furnish service under this warranty a) to repair damage resulting from attempts by personnel other than Tektronix representatives to install, repair or service the product; b) to repair damage resulting from improper use or connection to incompatible equipment; c) to repair any damage or malfunction caused by the use of non-Tektronix supplies; or d) to service a product that has been modified or integrated with other products when the effect of such modification or integration increases the time or difficulty of servicing the product.

THIS WARRANTY IS GIVEN BY TEKTRONIX IN LIEU OF ANY OTHER WARRANTIES, EXPRESS OR IMPLIED. TEKTRONIX AND ITS VENDORS DISCLAIM ANY IMPLIED WARRANTIES OF MERCHANTABILITY OR FITNESS FOR A PARTICULAR PURPOSE. TEKTRONIX' RESPONSIBILITY TO REPAIR OR REPLACE DEFECTIVE PRODUCTS IS THE SOLE AND EXCLUSIVE REMEDY PROVIDED TO THE CUSTOMER FOR BREACH OF THIS WARRANTY. TEKTRONIX AND ITS VENDORS WILL NOT BE LIABLE FOR ANY INDIRECT, SPECIAL, INCIDENTAL, OR CONSEQUENTIAL DAMAGES IRRESPECTIVE OF WHETHER TEKTRONIX OR THE VENDOR HAS ADVANCE NOTICE OF THE POSSIBILITY OF SUCH DAMAGES.

German Postal Information

Certificate of the Manufacturer/Importer

We hereby certify that the TDS 620A, TDS 640A, and TDS 644A Oscilloscopes and all factory-installed options complies with the RF Interference Suppression requirements of Postal Regulation Vfg. 243/1991, Amended per Vfg. 46/1992

The German Postal Service was notified that the equipment is being marketed.

The German Postal Service has the right to re-test the series and to verify that it complies.

TEKTRONIX

Bescheinigung des Herstellers/Importeurs

Hiermit wird bescheinigt, daß der/die/das TDS 620A, TDS 640A, and TDS 644A Oscilloscopes und alle fabrikinstallierten Optionen in Übereinstimmung mit den Bestimmungen der Amtsblatt-Verfügung Vfg. 243/1991 und Zusatzverfügung 46/1992 funkentstört sind.

Der Deutschen Bundespost wurde das Inverkehrbringen dieses Gerätes angezeigt und die Berechtigung zur Überprüfung der Serie auf Einhalten der Bestimmungen eingeräumt.

TEKTRONIX

NOTICE to the user/operator:

The German Postal Service requires that Systems assembled by the operator/user of this instrument must also comply with Postal Regulation, Vfg. 243/1991, Par. 2, Sect. 1.

HINWEIS für den Benutzer/Betreiber:

Die vom Betreiber zusammengestellte Anlage, innerhalb derer dieses Gerät eingesetzt wird, muß ebenfalls den Voraussetzungen nach Par. 2, Ziff. 1 der Vfg. 243/1991, genügen.

NOTICE to the user/operator:

The German Postal Service requires that this equipment, when used in a test setup, may only be operated if the requirements of Postal Regulation, Vfg. 243/1991, Par. 2, Sect. 1.8.1 are complied with.

HINWEIS für den Benutzer/Betreiber:

Dieses Gerät darf in Meßaufbauten nur betrieben werden, wenn die Voraussetzungen des Par. 2, Ziff. 1. 8.1 der Vfg. 243/1991 eingehalten werden.



EC Declaration of Conformity

We

Tektronix Holland N.V.
Marktweg 73A
8444 AB Heerenveen
The Netherlands

declare under sole responsibility that the

TDS 620A, 640A, & 644A Digitizing Oscilloscopes

meet the intent of Directive 89/336/EEC for Electromagnetic Compatibility.

Compliance was demonstrated to the following specifications as listed in the official Journal of the European Communities:

EN 50081 – 1 Emissions:

EN 55022	Radiated
EN 55022	Conducted
EN 60555 – 2	Power Harmonics

EN 50082 – 1 Immunity:

IEC 801 – 2	Electrostatic Discharge
IEC 801 – 3	RF Radiated
IEC 801 – 4	Fast Transients
IEC 801 – 5	Surge

Welcome

This is the User Manual for the *TDS Family Digitizing Oscilloscopes*.

The *Getting Started* section familiarizes you with the operation of the digitizing oscilloscope.

Operating Basics covers basic principles of the operation of the oscilloscope. These articles help you understand why your instrument works the way it does.

The *Reference* section teaches you how to perform specific tasks. See page 3-1 for a complete list of tasks covered in that section.

The *Appendices* provide an options listing, an accessories listing, and other useful information.

Related Manuals

The following documents are related to the use or service of the digitizing oscilloscope:

- The *TDS Family Digitizing Oscilloscopes Programmer Manual* (Tektronix part number 070-8709-XX) describes using a computer to control the digitizing oscilloscope through the GPIB interface.
- The *TDS Family Option 05 Video Trigger Instruction Manual* (Tektronix part number 070-8748-XX) describes use of the video trigger option (for TDS oscilloscopes equipped with that option only).
- The *TDS 520A, 524A, 540A, 544A, 620A, 640A & 644A Reference* (Tektronix part number 070-8711-XX) gives you a quick overview of how to operate the digitizing oscilloscope.
- The *TDS 620A, 640A, & 644A Performance Verification* (Tektronix part number 070-8717-XX) tells how to verify the performance of the digitizing oscilloscope.
- The *TDS 620A, 640A, & 644A Service Manual* (Tektronix part number 070-8718-XX) provides information for maintaining and servicing the digitizing oscilloscope to the module level.

Conventions

In the *Getting Started* and *Reference* sections, you will find various procedures which contain steps of instructions for you to perform. To keep those instructions clear and consistent, this manual uses the following conventions:

- In procedures, names of front panel controls and menu labels appear in boldface print.
- Front-panel and menu names also appear in the same upper and lower case as is used on the oscilloscope. Front panel names are all upper case letters, such as, **VERTICAL MENU**, and **CH 1**.
- Instruction steps are numbered. The number is omitted if there is only one step.
- When steps require that you make a sequence of selections using front-panel controls and menu buttons, an arrow (→) marks each transition between a front-panel button and a menu, or between menus. Also, whether a name is a main menu or side menu item is clearly indicated: Press **VERTICAL MENU** → **Coupling** (main) → **DC** (side) → **Bandwidth** (main) → **100 MHz** (side).

Using the convention just described results in instructions that are graphically intuitive and simplifies procedures. For example, the instruction just given replaces these five steps:

1. Press the front panel button **VERTICAL MENU**.
 2. Press the main menu button **Coupling**.
 3. Press the side-menu button **DC**.
 4. Press the main menu button **Bandwidth**.
 5. Press the side menu button **100 MHz**.
- Sometimes you may have to make a selection from a popup menu: Press **TRIGGER MENU** → **Type** (main) → **Edge** (popup). In this example, you repeatedly press the main menu button **Type** until **Edge** is highlighted in the pop-up menu.

Table of Contents

Safety	xi
--------------	----

Getting Started

Product Description	1-1
Start Up	1-3
Setting Up for the Examples	1-7
Example 1: Displaying a Waveform	1-8
Example 2: Multiple Waveforms	1-14
Example 3: Automated Measurements	1-18
Example 4: Saving Setups	1-24

Operating Basics

Overview	2-1
At a Glance	2-3
Triggering	2-13
Acquisition	2-19
Scaling and Positioning Waveforms	2-22
Measurements	2-26

Reference

Overview	3-1
Acquisition Modes	3-3
Autoset	3-8
Color (TDS 644A)	3-10
Cursor Measurements	3-15
Delayed Triggering	3-20
Display Modes	3-26
Edge Triggering	3-32
Fast Fourier Transforms	3-36

File System (Optional on TDS 620A & TDS 640A)	3-53
Hardcopy	3-57
Help	3-65
Horizontal Control	3-66
Limit Testing	3-70
Logic Triggering	3-75
Measurement System	3-83
Probe Cal	3-94
Probe Compensation	3-100
Probe Selection	3-102
Pulse Triggering	3-109
Remote Communication	3-116
Saving and Recalling Setups	3-120
Saving and Recalling Waveforms	3-123
Selecting Channels	3-126
Signal Path Compensation	3-128
Status	3-130
Triggering	3-132
Vertical Control	3-136
Waveform Differentiation	3-139
Waveform Integration	3-143
Waveform Math	3-148
Zoom	3-151

Appendices

Appendix A: Options and Accessories	A-1
Appendix B: Algorithms	A-7
Appendix C: Packaging for Shipment	A-21
Appendix D: Factory Initialization Settings	A-23

Glossary

Index

List of Figures

- Figure 1-1: Rear Panel Controls Used in Start Up 1-4
- Figure 1-2: ON/STBY Button 1-5
- Figure 1-3: Connecting a Probe for the Examples 1-7
- Figure 1-4: SETUP Button Location 1-8
- Figure 1-5: The Displayed Setup Menu 1-8
- Figure 1-6: Trigger Controls 1-9
- Figure 1-7: The Display After Factory Initialization 1-10
- Figure 1-8: The VERTICAL and HORIZONTAL Controls 1-11
- Figure 1-9: TRIGGER Controls 1-12
- Figure 1-10: AUTOSSET Button Location 1-12
- Figure 1-11: The Display After Pressing Autoset 1-13
- Figure 1-12: Display Signals Requiring Probe Compensation ... 1-13
- Figure 1-13: The Channel Buttons and Lights 1-14
- Figure 1-14: The Vertical Main Menu and Coupling Side Menu .. 1-16
- Figure 1-15: The Menus After Changing Channels 1-17
- Figure 1-16: Measure Main Menu and Select Measurement
Side Menu 1-18
- Figure 1-17: Four Simultaneous Measurement Readouts 1-20
- Figure 1-18: General Purpose Knob Indicators 1-21
- Figure 1-19: Snapshot of Channel 1 1-22
- Figure 1-20: Save/Recall Setup Menu 1-25
- Figure 2-1: Triggered Versus Untriggered Displays 2-13
- Figure 2-2: Trigger Holdoff Time Ensures Valid Triggering 2-16
- Figure 2-3: Slope and Level Controls Help Define the Trigger ... 2-17
- Figure 2-4: Acquisition: Input Analog Signal, Sample, and
Digitize 2-19
- Figure 2-5: Real-Time Sampling 2-20
- Figure 2-6: Scaling and Positioning 2-22
- Figure 2-7: Aliasing 2-24
- Figure 2-8: Graticule, Cursor and Automated Measurements ... 2-26

Figure 2-9: Cursor Modes	2-27
Figure 3-1: How the Acquisition Modes Work	3-4
Figure 3-2: Acquisition Menu and Readout	3-5
Figure 3-3: Acquire Menu — Stop After	3-6
Figure 3-4: Display Menu — Setting	3-10
Figure 3-5: Display Menu — Palette Colors	3-12
Figure 3-6: Display Menu — Map Reference Colors	3-13
Figure 3-7: Display Menu — Restore Colors	3-14
Figure 3-8: Cursor Types	3-15
Figure 3-9: Cursor Modes	3-16
Figure 3-10: H Bars Cursor Menu and Readouts	3-17
Figure 3-11: Paired Cursor Menu and Readouts	3-18
Figure 3-12: Delayed Runs After Main	3-20
Figure 3-13: Delayed Triggerable	3-20
Figure 3-14: How the Delayed Triggers Work	3-22
Figure 3-15: Delayed Trigger Menu	3-24
Figure 3-16: Display Menu — Style	3-26
Figure 3-17: Trigger Point and Level Indicators	3-28
Figure 3-18: Edge Trigger Readouts	3-32
Figure 3-19: Main Trigger Menu — Edge Type	3-33
Figure 3-20: System Response to an Impulse	3-37
Figure 3-21: Define FFT Waveform Menu	3-38
Figure 3-22: FFT Math Waveform in Math1	3-39
Figure 3-23: Cursor Measurement of an FFT Waveform	3-41
Figure 3-24: Waveform Record vs. FFT Time Domain Record ...	3-43
Figure 3-25: FFT Time Domain Record vs. FFT Frequency Domain Record	3-43
Figure 3-26: How Aliased Frequencies Appear in an FFT	3-47
Figure 3-27: Windowing the FFT Time Domain Record	3-50
Figure 3-28: FFT Windows and Bandpass Characteristics	3-52
Figure 3-29: File Utilities	3-53
Figure 3-30: File System — Labelling Menu	3-55
Figure 3-31: Utility Menu — System I/O	3-58

Figure 3-32: Hardcopy Formats	3-59
Figure 3-33: Date and Time Display	3-61
Figure 3-34: Connecting the Digitizing Oscilloscope Directly to the Hardcopy Device	3-62
Figure 3-35: Connecting the Digitizing Oscilloscope and Hardcopy Device Via a PC	3-63
Figure 3-36: Initial Help Screen	3-65
Figure 3-37: Horizontal Controls	3-66
Figure 3-38: Record View and Time Base Readouts	3-67
Figure 3-39: Comparing a Waveform to a Limit Template	3-70
Figure 3-40: Acquire Menu — Create Limit Test Template	3-71
Figure 3-41: Logic Trigger Readouts	3-76
Figure 3-42: Logic Trigger Menu	3-78
Figure 3-43: Logic Trigger Menu — Time Qualified TRUE	3-81
Figure 3-44: Measurement Readouts	3-86
Figure 3-45: Measure Menu	3-87
Figure 3-46: Measure Menu — Gating	3-88
Figure 3-47: Measure Menu — Reference Levels	3-90
Figure 3-48: Measure Delay Menu — Delay To	3-91
Figure 3-49: Snapshot Menu and Readout	3-92
Figure 3-50: Probe Cal Menu and Gain Compensation Display .	3-96
Figure 3-51: Re-use Probe Calibration Data Menu	3-98
Figure 3-52: How Probe Compensation Affects Signals	3-100
Figure 3-53: P6139A Probe Adjustment	3-101
Figure 3-54: The P6009 and P6015A High Voltage Probes	3-103
Figure 3-55: A6303 Current Probe Used in the AM 503S Opt. 03	3-105
Figure 3-56: Pulse Trigger Readouts	3-109
Figure 3-57: Main Trigger Menu — Glitch Class	3-111
Figure 3-58: Main Trigger Menu—Runt Class	3-114
Figure 3-59: Typical GPIB Network Configuration	3-117
Figure 3-60: Stacking GPIB Connectors	3-117
Figure 3-61: Connecting the Digitizing Oscilloscope to a Controller	3-118
Figure 3-62: Utility Menu	3-119

Figure 3-63: Save/Recall Setup Menu	3-120
Figure 3-64: Save Waveform Menu	3-124
Figure 3-65: More Menu	3-125
Figure 3-66: The Channel Readout	3-126
Figure 3-67: Waveform Selection Priority	3-127
Figure 3-68: Performing a Signal Path Compensation	3-129
Figure 3-69: Status Menu — System	3-130
Figure 3-70: Banner Display	3-131
Figure 3-71: TRIGGER Controls and Status Lights	3-132
Figure 3-72: Example Trigger Readouts	3-134
Figure 3-73: Record View, Trigger Position, and Trigger Level Bar Readouts	3-135
Figure 3-74: Vertical Readouts and Channel Menu	3-137
Figure 3-75: Derivative Math Waveform	3-140
Figure 3-76: Peak-Peak Amplitude Measurement of a Derivative Waveform	3-141
Figure 3-77: Integral Math Waveform	3-144
Figure 3-78: H Bars Cursors Measure an Integral Math Waveform	3-145
Figure 3-79: More Menu	3-148
Figure 3-80: Dual Waveform Math Main and Side Menus	3-150
Figure 3-81: Zoom Mode with Horizontal Lock Set to None	3-152
Figure A-1: MCross Calculations	A-10
Figure A-2: Fall Time	A-13
Figure A-3: Rise Time	A-17
Figure A-4: Choosing Minima or Maxima to Use for Envelope Measurements	A-19

List of Tables

Table 1-1: Fuse and Fuse Cap Part Numbers	1-4
Table 3-1: Autoset Defaults	3-9
Table 3-2: XY Format Pairs	3-30
Table 3-3: Logic Triggers	3-77
Table 3-4: Measurement Definitions	3-83
Table 3-5: Probe Cal Status	3-98
Table 3-6: TDS 600A Compatible Probes	3-107
Table 3-7: Probes by Application	3-108
Table 3-8: Pulse Trigger Definitions	3-110
Table 3-9: Zoom Defaults	3-153
Table A-1: International Power Cords	A-1
Table A-2: Standard Accessories	A-3
Table A-3: Optional Accessories	A-4
Table A-4: Accessory Software	A-5
Table A-5: Factory Initialization Defaults	A-23



Table of Contents

Safety

Please take a moment to review these safety precautions. They are provided for your protection and to prevent damage to the digitizing oscilloscope. This safety information applies to all operators and service personnel.

Symbols and Terms

These two terms appear in manuals:

-  statements identify conditions or practices that could result in damage to the equipment or other property.
-  statements identify conditions or practices that could result in personal injury or loss of life.

These two terms appear on equipment:

- *CAUTION* indicates a personal injury hazard not immediately accessible as one reads the marking or a hazard to property including the equipment itself.
- *DANGER* indicates a personal injury hazard immediately accessible as one reads the marking.

This symbol appears in manuals:



Static-Sensitive Devices

These symbols appear on equipment:



DANGER
High Voltage



Protective
ground (earth)
terminal



ATTENTION
Refer to
manual

Specific Precautions

Observe all of these precautions to ensure your personal safety and to prevent damage to either the digitizing oscilloscope or equipment connected to it.

Power Source

The digitizing oscilloscope is intended to operate from a power source that will not apply more than 250 V_{RMS} between the supply conductors or between either supply conductor and ground. A protective ground connection, through the grounding conductor in the power cord, is essential for safe system operation.

Grounding the Digitizing Oscilloscope

The digitizing oscilloscope is grounded through the power cord. To avoid electric shock, plug the power cord into a properly wired receptacle where earth ground has been verified by a qualified service person. Do this before making connections to the input or output terminals of the digitizing oscilloscope.

Without the protective ground connection, all parts of the digitizing oscilloscope are potential shock hazards. This includes knobs and controls that may appear to be insulators.

Use the Proper Power Cord

Use only the power cord and connector specified for your product. Use only a power cord that is in good condition.

Use the Proper Fuse

To avoid fire hazard, use only the fuse specified in the parts list for your product, matched by type, voltage rating, and current rating.

Do Not Remove Covers or Panels

To avoid personal injury, do not operate the digitizing oscilloscope without the panels or covers.

Electric Overload

Never apply a voltage to a connector on the digitizing oscilloscope that is outside the voltage range specified for that connector.

Do Not Operate in Explosive Atmospheres

The digitizing oscilloscope provides no explosion protection from static discharges or arcing components. Do not operate the digitizing oscilloscope in an atmosphere of explosive gases.

Product Description

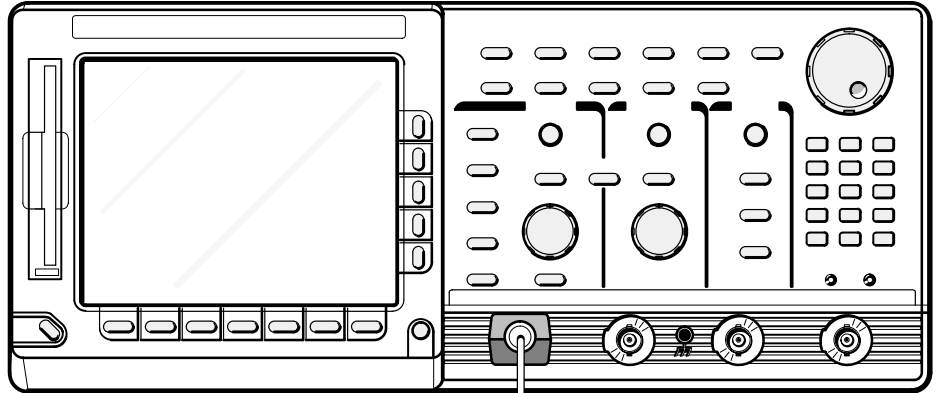

Tektronix TDS 600A Digitizing Oscilloscopes are superb tools for acquiring, displaying, and measuring waveforms. Their performance addresses the needs of both benchtop lab and portable applications with the following features:

- 500 MHz maximum analog bandwidth.
- 2 Gigasamples/second maximum digitizing rate.
- Four channels for acquisition — the TDS 640A & 644A let you use and display all four channels simultaneously; the TDS 620A lets you use and display any two channels simultaneously. All channels can acquire at the maximum digitizing rate.
- Waveform Math — Invert a single waveform and add, subtract, multiply, and divide two waveforms. On instruments with Advanced DSP Math (standard on the TDS 644A), integrate or differentiate a single waveform or perform an FFT (fast fourier transform) on a waveform to display its magnitude or phase versus its frequency.
- Eight-bit digitizers.
- Up to 2,000-sample record length per channel.
- Full GPIB software programmability. Hardcopy output using RS-232 or Centronics ports (Optional on TDS 620A & 640A) and the GPIB.
- Complete measurement and documentation capability.
- Intuitive graphic icon operation blended with the familiarity of traditional horizontal and vertical knobs.
- On-line help at the touch of a button.

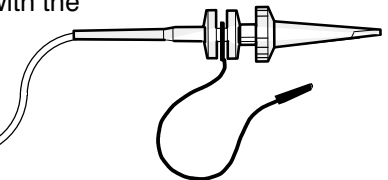

Start Up

Before you use the digitizing oscilloscope, ensure that it is properly installed and powered on.

Before You Begin

To ensure maximum accuracy for your most critical measurements, you should know about signal path compensation and the proper use of the P6139A probe shipped with your oscilloscope as a standard accessory.

Signal Path Compensation

Be sure you compensate your oscilloscope for the surrounding temperature. This action, called *Signal Path Compensation (SPC)*, ensures maximum possible accuracy for your most critical measurements. See *Signal Path Compensation* on page 3-128 for a description of and operating information on this feature.

P6205 Active Probe

Be sure you use the appropriate probe. Do not use the optional P6205 Active Probe to measure signals above ± 10 volts since errors in signal measurement will result. Instead, use the standard accessory P6139A Passive Probe or one of the passive probes listed in Appendix A under *Accessory Probes*. The P6139A probe is for measurements up to ± 500 volts.



Using the P6205 Active Probe to measure signals greater than ± 40 volts may damage the probe.

Operation

To properly install and power on the digitizing oscilloscope, do the following:

Installation

1. Be sure you have the appropriate operating environment. Specifications for temperature, relative humidity, altitude, vibrations, and emissions are included in the *TDS 620A, 640A, & 644A Performance Verification* manual (Tektronix part number 070-8717-XX).

2. Leave space for cooling. Do this by verifying that the air intake and exhaust holes on the sides of the cabinet (where the fan operates) are free of any airflow obstructions. Leave at least 5.1 cm (2 inches) free on each side.

WARNING

To avoid electrical shock, be sure that the power cord is disconnected before checking the fuse.

3. Check the fuse to be sure it is the proper type and rating (see Figure 1-1). You can use either of two fuses. Each fuse requires its own cap (see Table 1-1). The digitizing oscilloscope is shipped with the UL approved fuse installed.
4. Check that you have the proper electrical connections. The digitizing oscilloscope requires 90 to 250 VAC_{RMS}, continuous range, 47 Hz to 63 Hz, and may require up to 300 W.
5. Connect the proper power cord from the rear-panel power connector (see Figure 1-1) to the power system.

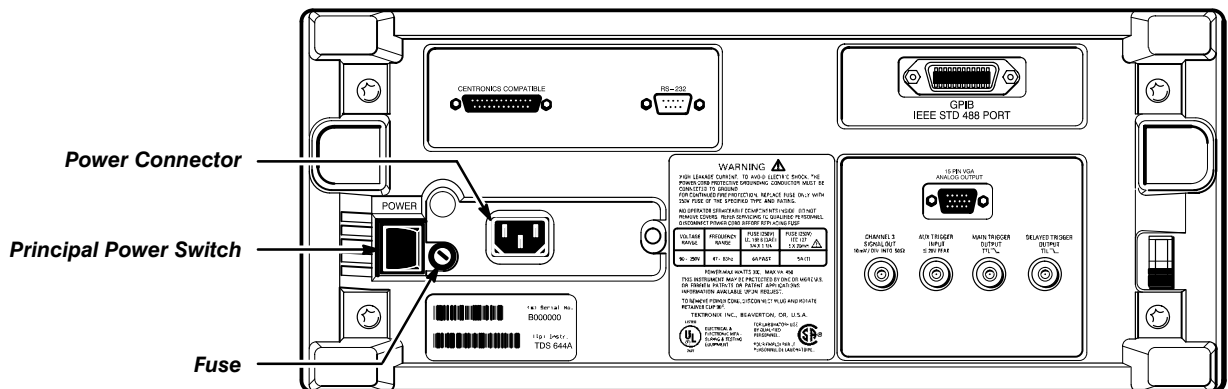

Figure 1-1: Rear Panel Controls Used in Start Up

Table 1-1: Fuse and Fuse Cap Part Numbers

Fuse	Fuse Part Number	Fuse Cap Part Number
.25 inch × 1.25 inch (UL 198.6, 3AG): 6 A FAST, 250 V.	159-0013-00	200-2264-00
5 mm × 20 mm (IEC 127): 5 A (T), 250 V.	159-0210-00	200-2265-00

Front Cover Removal

Remove the front cover by grasping its left and right edges and snapping it off of the front subpanel. (When reinstalling, align and snap back on.)

Power On

1. Check that the rear-panel principal power switch is on (see Figure 1-1). The principal power switch controls all AC power to the instrument.
2. If the oscilloscope is not powered on (the screen is blank), push the front-panel **ON/STBY** button to toggle it on (see Figure 1-2).

The **ON/STBY** button controls power to most of the instrument circuits. Power continues to go to certain parts even when this switch is set to STBY.

Once the digitizing oscilloscope is installed, it is typical to leave the principal power switch on and use the **ON/STBY** button as the power switch.

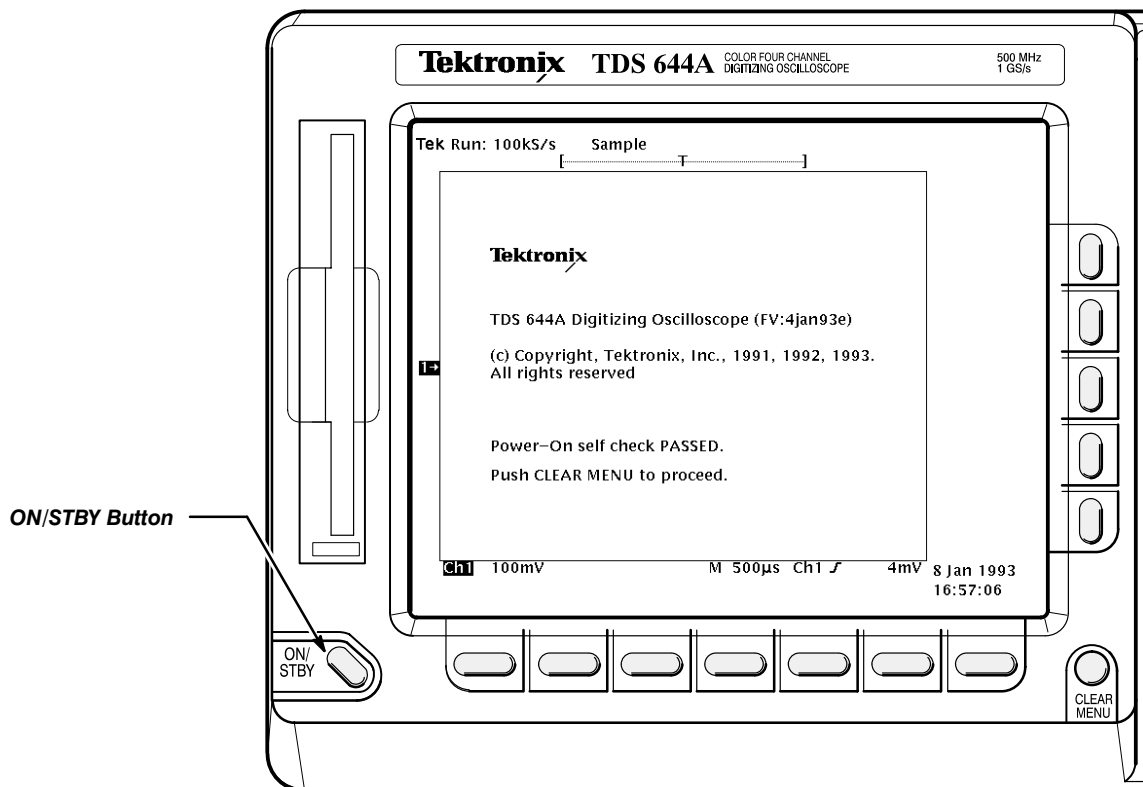

Figure 1-2: ON/STBY Button

Self Test

Check the self test results. The digitizing oscilloscope automatically performs power-up tests each time it is turned on. It will come up with a display screen that states whether or not it passed self test. (If the self test passed, the status display screen will be removed after a few seconds.)

If the self test fails, call your local Tektronix Service Center. Depending on the type of failure, you may still be able to use the oscilloscope before it is serviced.

Power Off

Toggle the **ON/STBY** switch to turn off the oscilloscope.

Setting Up for the Examples

All the examples use the same setup. Once you perform this setup, you do not have to change the signal connections for any of the other examples.

Remove all probes and signal inputs from the input BNC connectors along the lower right of the front panel. Then, using one of the probes supplied with the digitizing oscilloscope, connect from the **CH 1** connector to the **PROBE COMPENSATION** connectors (see Figure 1-3).

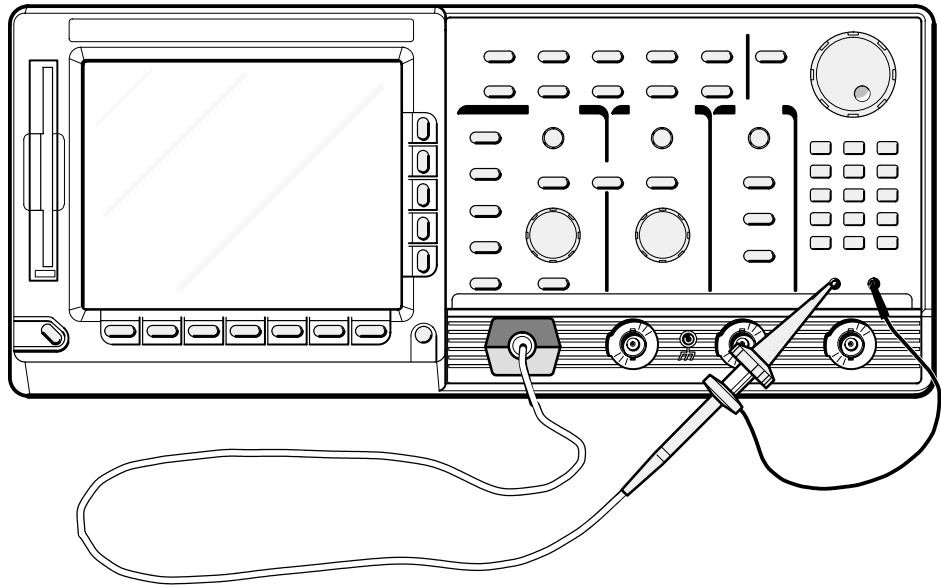

Figure 1-3: Connecting a Probe for the Examples

Example 1: Displaying a Waveform

In this first example you learn about resetting the digitizing oscilloscope, displaying and adjusting a waveform, and using the autoset function.

Resetting the Digitizing Oscilloscope

All examples in the tutorial begin by resetting the digitizing oscilloscope to a known factory default state. Reset the oscilloscope when you begin a new task and need to “start fresh” with known default settings.

1. Press the save/recall **SETUP** button to display the Setup menu (Figure 1-4).

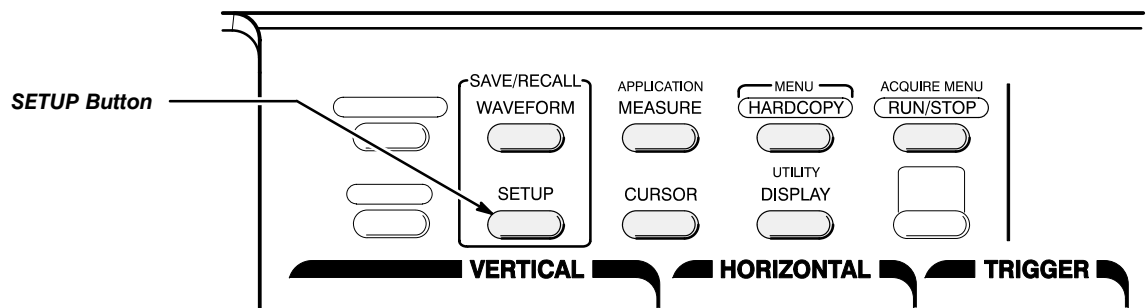

Figure 1-4: SETUP Button Location

The digitizing oscilloscope displays *main menus* along the bottom of the screen. Figure 1-5 shows the Setup main menu.

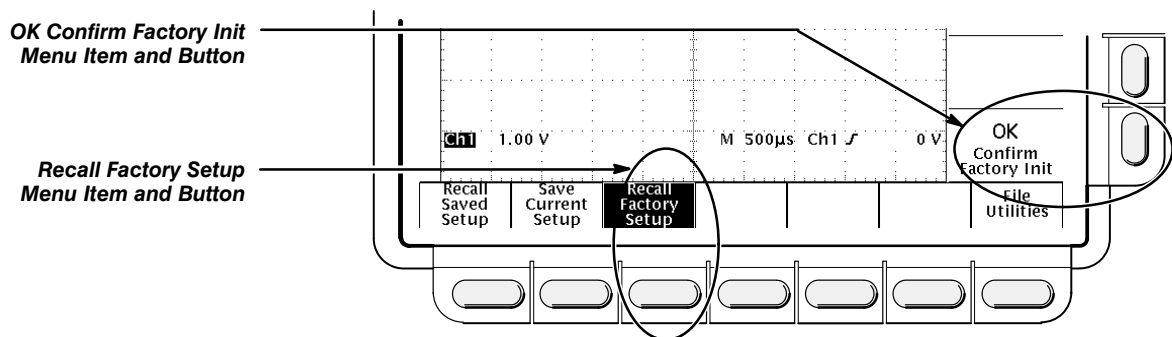

Figure 1-5: The Displayed Setup Menu

2. Press the button directly below the **Recall Factory Setup** menu item.

The display shows *side menus* along the right side of the screen. The buttons to select these side menu items are to the right of the side menu.

Because an accidental instrument reset could destroy a setup that took a long time to create, the digitizing oscilloscope asks you to verify the **Recall Factory Setup** selection (see Figure 1-5).

3. Press the button to the right of the **OK Confirm Factory Init** side menu item.

NOTE

*This manual uses the following notation to represent the sequence of selections you made in steps 1, 2 and 3: Press save/recall **SETUP** → **Recall Factory Setup** (main) → **OK Confirm Factory Init** (side).*



Note that a clock icon appears on screen. The oscilloscope displays this icon when performing operations that take longer than several seconds.

4. Press **SET LEVEL TO 50%** (see Figure 1-6) to be sure the oscilloscope triggers on the input signal.

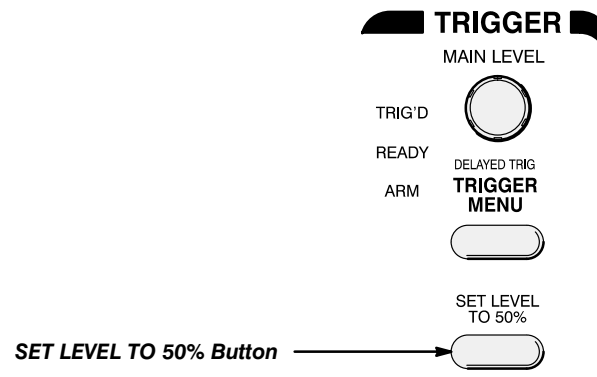

Figure 1-6: Trigger Controls

Display Elements

Figure 1-7 shows the display that results from the instrument reset. There are several important points to observe:

- The *trigger level bar* shows that the waveform is triggered at a level near 50% of its amplitude (from step 4).
- The *trigger position indicator* shows that the trigger position of the waveform is located at the horizontal center of the graticule.
- The *channel reference indicator* shows the vertical position of channel 1 with no input signal. This indicator points to the ground level for the channel when its vertical offset is set to 0 V in the vertical menu; when vertical offset is *not* set to 0 V, it points to the vertical offset level.
- The *trigger readout* shows that the digitizing oscilloscope is triggering on channel 1 (**Ch1**) on a rising edge, and that the trigger level is about 200–300 mV.
- The *time base readout* shows that the main time base is set to a horizontal scale of 500 μ s/div.
- The *channel readout* indicates that channel 1 (**Ch1**) is displayed with DC coupling. (In AC coupling, \sim appears after the volts/div readout.) The digitizing oscilloscope always displays channel 1 at reset.

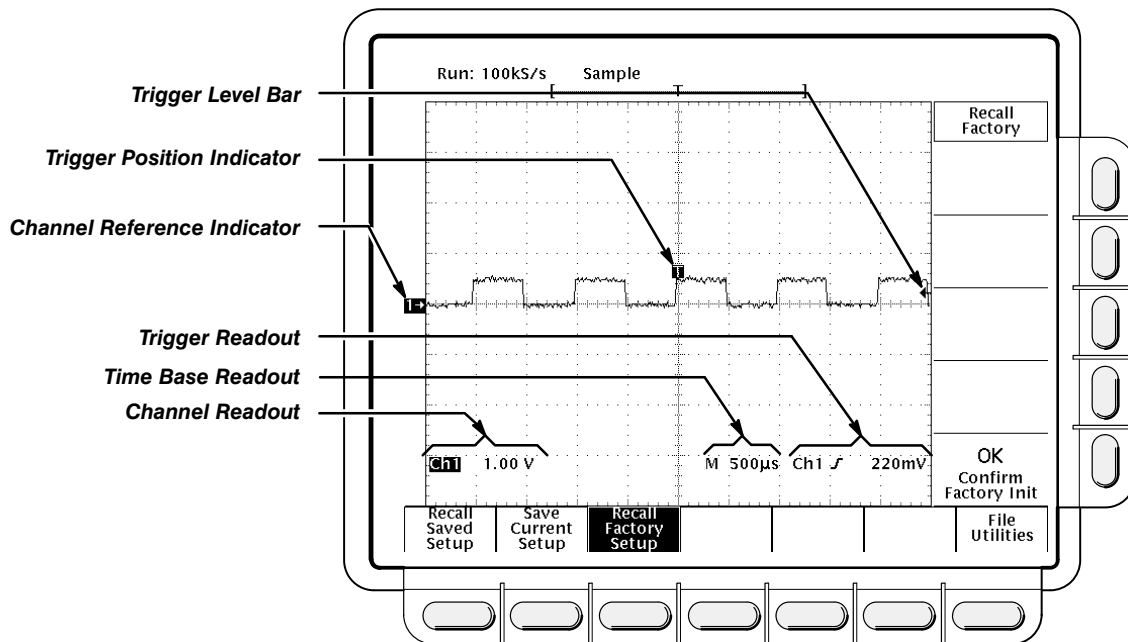

Figure 1-7: The Display After Factory Initialization

Right now, the channel, time base, and trigger readouts appear in the graticule area because a menu is displayed. You can press the **CLEAR MENU** button at any time to remove any menus and to move the readouts below the graticule.

Adjusting the Waveform Display

The display shows the probe compensation signal. It is a 1 kHz square wave of approximately 0.5 V amplitude. You can adjust the size and placement of the waveform using the front-panel knobs.

Figure 1-8 shows the main **VERTICAL** and **HORIZONTAL** sections of the front panel. Each has **SCALE** and **POSITION** knobs.

1. Turn the vertical **SCALE** knob clockwise. Observe the change in the displayed waveform and the channel readout at the bottom of the display.

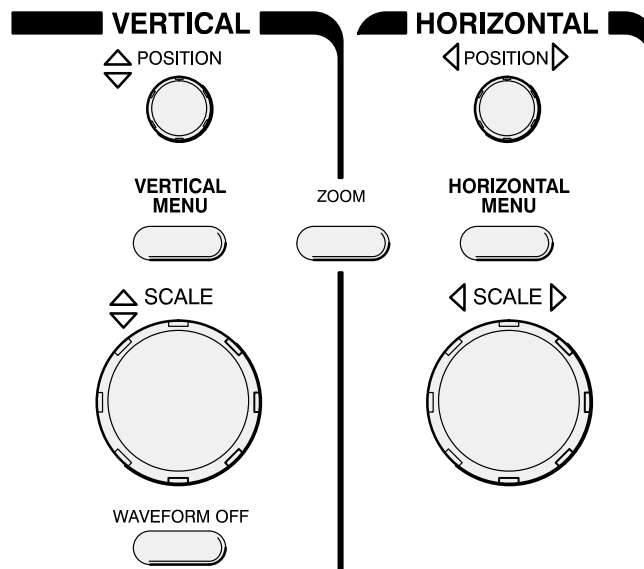

Figure 1-8: The **VERTICAL** and **HORIZONTAL** Controls

2. Turn the vertical **POSITION** knob first one direction, then the other. Observe the change in the displayed waveform. Then return the waveform to the center of the graticule.
3. Turn the horizontal **SCALE** knob one click clockwise. Observe the time base readout at the bottom of the display. The time base should be set to 250 $\mu\text{s}/\text{div}$ now, and you should see two complete waveform cycles on the display.

Using Autoset

When you first connect a signal to a channel and display it, the signal displayed may not be scaled and triggered correctly. Use the autoset function and you should quickly get a meaningful display.

When you reset the digitizing oscilloscope, you see a clear, stable display of the probe compensation waveform. That is because the probe compensation signal happens to display well at the default settings of the digitizing oscilloscope.

Example 1: Displaying a Waveform

1. To create an unstable display, slowly turn the trigger **MAIN LEVEL** knob (see Figure 1-9) first one direction, then the other. Observe what happens when you move the trigger level above the highest part of the displayed waveform. Leave the trigger level in that untriggered state.
2. Press **AUTOSET** (see Figure 1-10) and observe the stable waveform display.

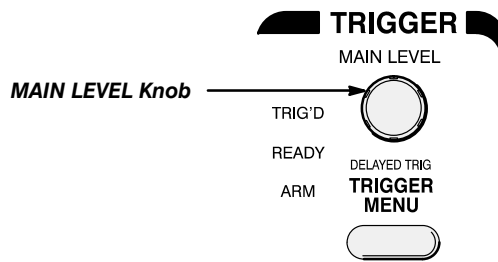

Figure 1-9: TRIGGER Controls

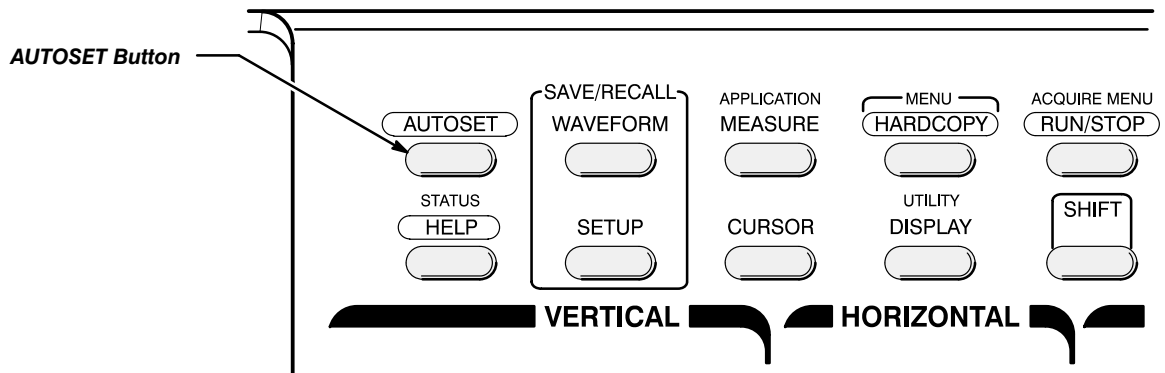

Figure 1-10: AUTOSET Button Location

Figure 1-11 shows the display after pressing **AUTOSET**. If necessary, you can adjust the waveform now by using the knobs discussed earlier in this example.

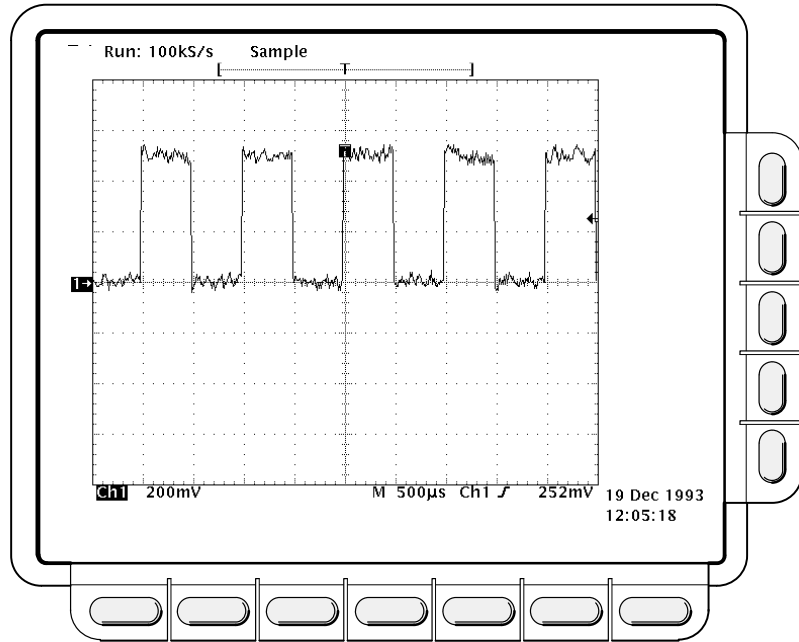

Figure 1-11: The Display After Pressing Autoset

NOTE

If you are using a passive probe, such as the standard P6139A probe, the corners on your displayed signal may look rounded or pointed (see Figure 1-12). If so, then you may need to compensate your probe. The documentation included with such probes explains how to compensate your probe.



Figure 1-12: Display Signals Requiring Probe Compensation

Example 2: Multiple Waveforms

In this example you learn how to display and control more than one waveform at a time.

Adding a Waveform

The **VERTICAL** section of the front panel contains the channel selection buttons. These are **CH 1**, **CH 2**, **CH 3**, **CH 4**, and **MORE** (Figure 1-13); on the TDS 620A, they are **CH 1**, **CH 2**, **AUX 1**, **AUX 2**, and **MORE**.

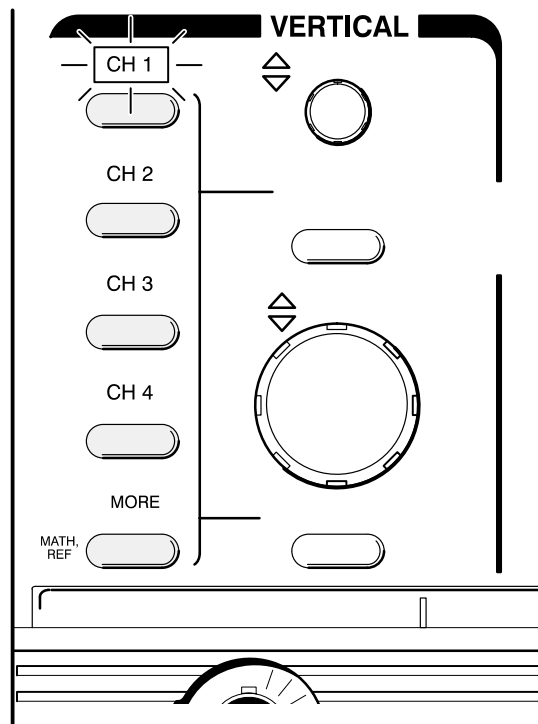

Figure 1-13: The Channel Buttons and Lights

Each of the channel (**CH**) buttons has a light above its label. Right now, the **CH 1** light is on. That light indicates that the vertical controls are set to adjust channel 1.

The following steps add a waveform to the display.

1. If you are not continuing from the previous example, follow the instructions on page 1-7 under the heading *Setting Up for the Examples*.
2. Press **SETUP** → **Recall Factory Setup** (main) → **OK Confirm Factory Init** (side).

3. Press **AUTOSET**.
4. Press **CH 2**.

The display shows a second waveform, which represents the signal on channel 2. Since there is nothing connected to the **CH 2** input connector, this waveform is a flat line.

There are several other important things to observe:

- The channel readout on the display now shows the settings for both **Ch1** and **Ch2**.
 - There are two channel indicators at the left edge of the graticule. Right now, they overlap.
 - The light next to the **CH 2** button is now on, and the **CH 1** light is off. Because the knobs control only one channel at a time, the vertical controls are now set to adjust channel 2.
 - The trigger readout still indicates that the trigger is detecting trigger events on **Ch1**. The trigger source is not changed simply by adding a channel. (You can change the trigger source by using the **TRIGGER MENU** button to display the trigger menu.)
5. Turn the vertical **POSITION** knob clockwise to move the channel 2 waveform up on the graticule. You will notice that the channel reference indicator for channel 2 moves with the waveform.
 6. Press **VERTICAL MENU → Coupling** (main).

The **VERTICAL MENU** button displays a menu that gives you control over many vertical channel parameters (Figure 1-14). Although there can be more than one channel displayed, the vertical menu and buttons only adjust the selected channel.

Each menu item in the Vertical menu displays a side menu. Right now, the **Coupling** item in the main menu is highlighted, which means that the side menu shows the coupling choices. At the top of the side menu, the menu title shows the channel affected by the menu choices. That always matches the lighted channel button.

7. Press **Ω** (side) to toggle the selection to **50 Ω**. That changes the input coupling of channel 2 from 1 MΩ to 50 Ω. The channel readout for channel 2 (near the bottom of the graticule) now shows an Ω indicator.

Example 2: Multiple Waveforms

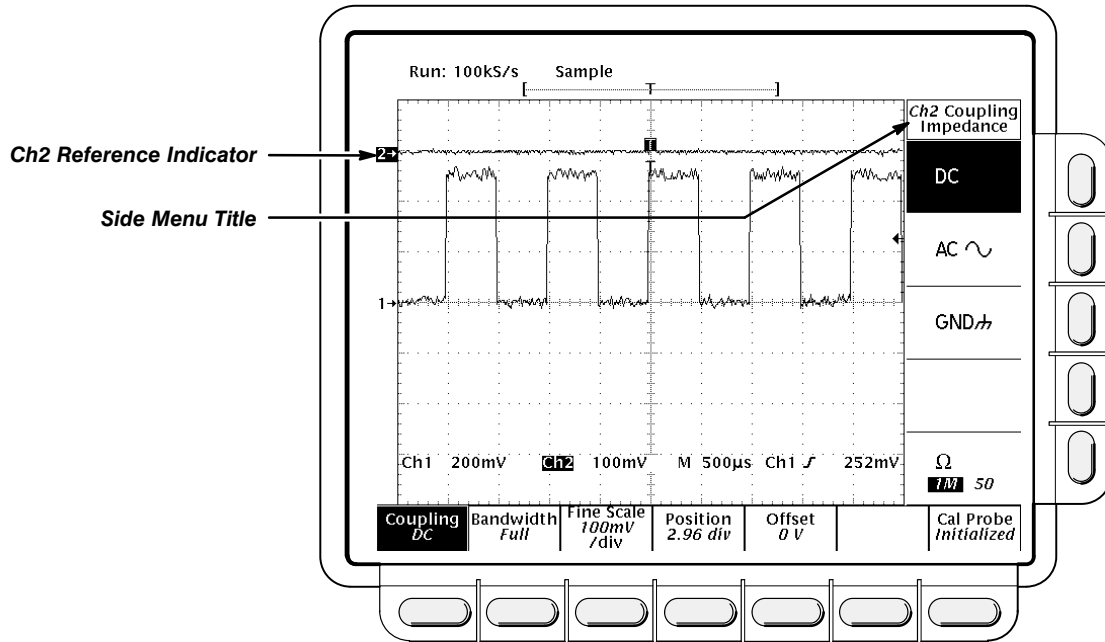

Figure 1-14: The Vertical Main Menu and Coupling Side Menu

Changing Controls to Another Channel

Pressing a channel (**CH**) button sets the vertical controls to that channel. It also adds the channel to the display if that waveform is not already displayed.

1. Press **CH 1**.

Observe that now the side menu title shows **Ch1** (Figure 1-15), and that the light above **CH 1** is lighted. The highlighted menu item in the side menu has changed from the **50 Ω** channel 2 setting to the **1 MΩ** impedance setting of channel 1.

2. Press **CH 2** → **Ω** (side) to toggle the selection to **1 MΩ**. That returns the coupling impedance of channel 2 to its initial state.

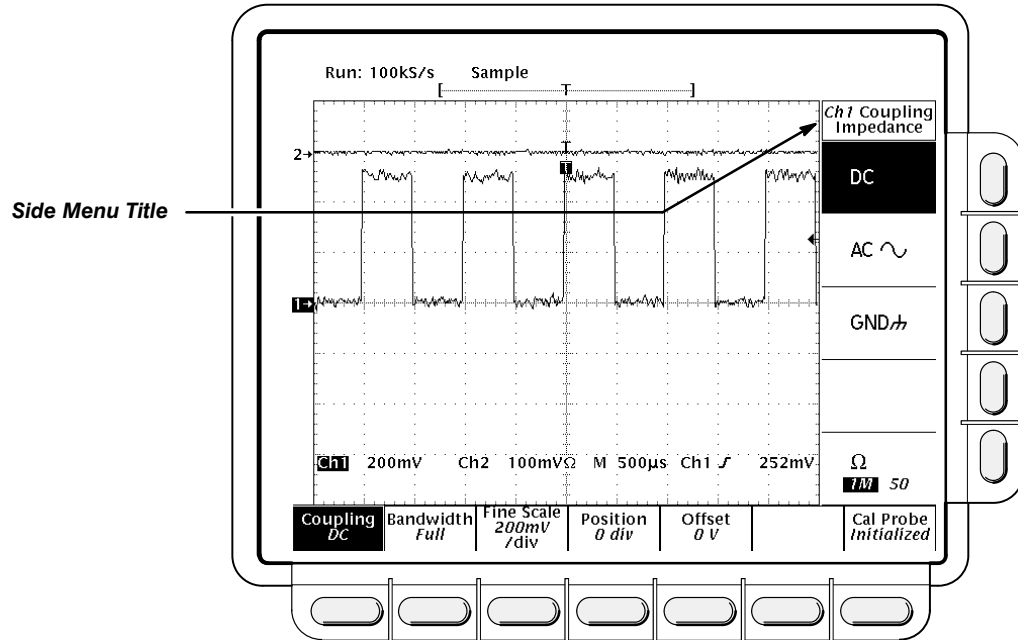

Figure 1-15: The Menu After Changing Channels

Removing a Waveform

Pressing the **WAVEFORM OFF** button removes the waveform for the currently selected channel. If the waveform you want to remove is not already selected, select that channel using the channel (**CH**) button.

1. Press **WAVEFORM OFF** (under the vertical **SCALE** knob).

Since the **CH 2** light was on when you pressed the **WAVEFORM OFF** button, the channel 2 waveform was removed.

The channel (**CH**) lights now indicate channel 1. Channel 1 has become the selected channel. When you remove the last waveform, all the **CH** lights are turned off.

2. Press **WAVEFORM OFF** again to remove the channel 1 waveform.

Example 3: Automated Measurements

In this example you learn how to use the automated measurement system to get numeric readouts of important waveform characteristics.

Displaying Automated Measurements

To use the automated measurement system, you must have a stable display of your signal. Also, the waveform must have all the segments necessary for the measurement you want. For example, a rise time measurement requires at least one rising edge, and a frequency measurement needs at least one complete cycle.

1. If you are not continuing from the previous example, follow the instructions on page 1-7 under the heading *Setting Up for the Examples*.
2. Press **SETUP** → **Recall Factory Setup** (main) → **OK Confirm Factory Init** (side).
3. Press **AUTOSET**.
4. Press **MEASURE** to display the Measure main menu (see Figure 1-16).

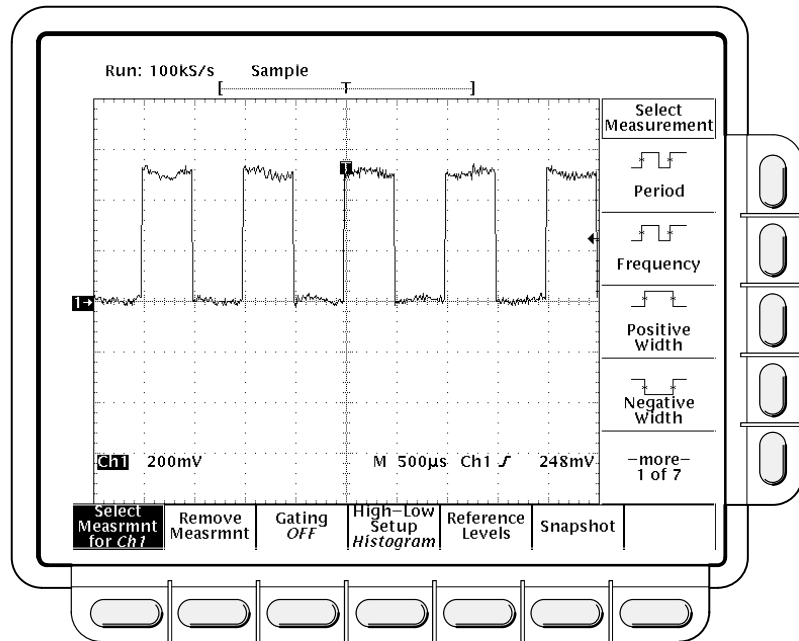

Figure 1-16: Measure Main Menu and Select Measurement Side Menu

5. If it is not already selected, press **Select Measrmt** (main). The readout for that menu item indicates which channel the measurement will be taken from. All automated measurements are made on the selected channel.

The Select Measurement side menu lists some of the measurements that can be taken on waveforms. There are many different measurements available; up to four can be taken and displayed at any one time. Pressing the button next to the **–more–** menu item brings up the other measurement selections.



6. Press **Frequency** (side). If the **Frequency** menu item is not visible, press **–more–** (side) repeatedly until the **Frequency** item appears. Then press **Frequency** (side).

Observe that the frequency measurement appears within the right side of the graticule area. The measurement readout includes the notation **Ch1**, meaning that that measurement is taken on the channel 1 waveform. (To take a measurement on another channel, select that channel, and then select the measurement.)

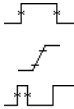

7. Press **Positive Width** (side) → **–more–** (side) → **Rise Time** (side) → **Positive Duty Cycle** (side).

All four measurements are displayed. Right now, they cover a part of the graticule area, including the displayed waveforms.

8. To move the measurement readouts outside the graticule area, press **CLEAR MENU** (see Figure 1-17).

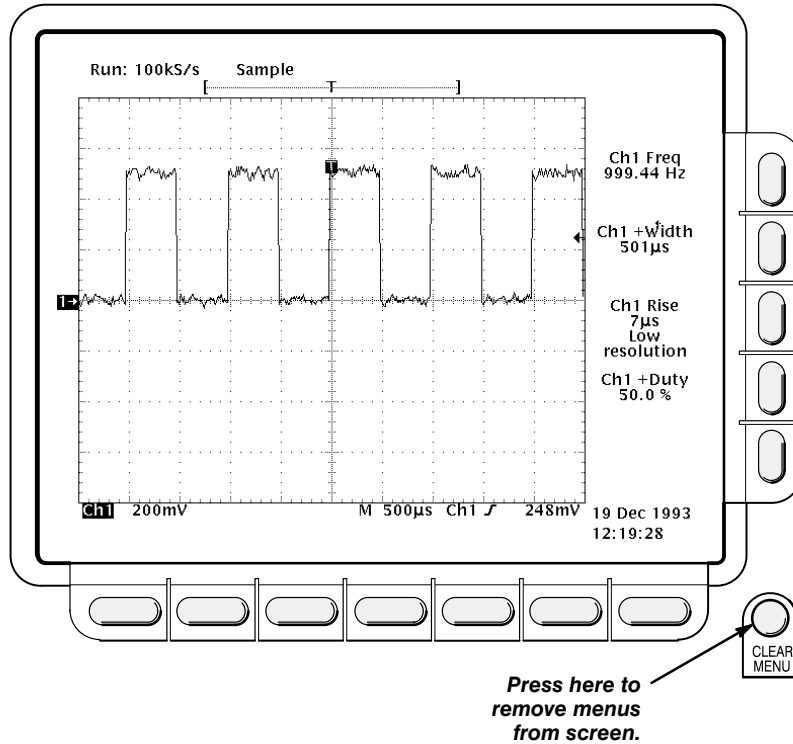

Figure 1-17: Four Simultaneous Measurement Readouts

Removing Measurement Readouts

The Measure menu lets you remove measurements you no longer want displayed. You can remove any one measurement, or you can remove them all with a single menu item.

Press **MEASURE** → **Remove Measrmtnt** (main) → **Measurement 1**, **Measurement 2**, and **Measurement 4** (side) to remove those measurements. Leave the rise time measurement displayed.

Changing the Measurement Reference Levels



By default, the measurement system will use the 10% and 90% levels of the waveform for taking the rise time measurement. You can change these values to other percentages or change them to absolute voltage levels.

To examine the current values, press **Reference Levels** (main) → **High Ref** (side).

The General Purpose Knob

The general purpose knob, the large knob, is now set to adjust the high reference level (Figure 1-18).

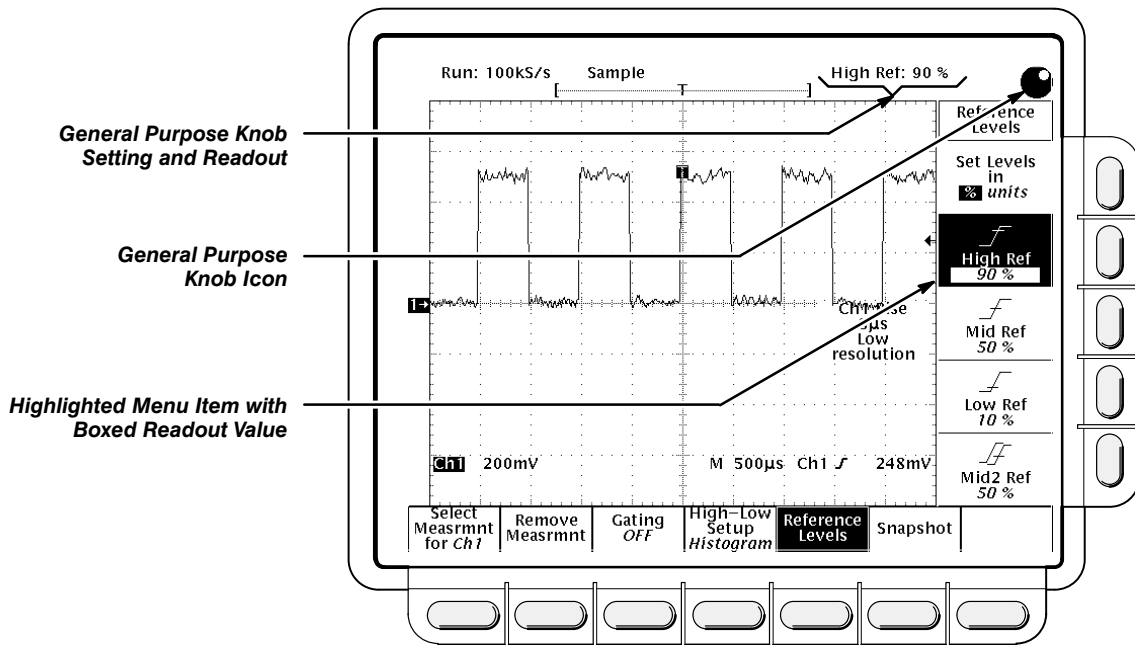

Figure 1-18: General Purpose Knob Indicators

There are several important things to observe on the screen:

- The knob icon appears at the top of the screen. The knob icon indicates that the general purpose knob has just been set to adjust a parameter.
- The upper right corner of the screen shows the readout **High Ref: 90%**.
- The **High Ref** side menu item is highlighted, and a box appears around the 90% readout in the **High Ref** menu item. The box indicates that the general purpose knob is currently set to adjust that parameter.

Turn the general purpose knob left and right, and then use it to adjust the high level to 80%. That sets the high measurement reference to 80%.

Hint: To make large changes quickly with the general purpose knob, press the **SHIFT** button before turning the knob. When the light above the **SHIFT** button is on and the display says **Coarse Knobs** in the upper-right corner, the general purpose knob speeds up significantly.

The Numeric Keypad

Any time the general purpose knob is set to adjust a numeric parameter, you can enter the value as a number using the keypad instead of using the knob. Always end the entry of a number by pressing the **ENTER** (↵).

The numeric keypad also provides multipliers for engineering exponents, such as **m** for milli, **M** for mega, and **µ** for micro. To enter these multiplier values, press the **SHIFT** button, then press the multiplier.

Example 3: Automated Measurements



1. Press **Low Ref** (side).
2. On the numeric keypad, press the **2**, the **0**, and the **ENTER** (↵) buttons, which sets the low measurement reference to 20%. Observe that the rise-time value has changed.
3. Press **Remove Measrmt** (main) → **All Measurements** (side). That returns the display to its original state.

Displaying a Snapshot of Automated Measurements

You have seen how to display up to four individual automated measurements on screen. You can also pop up a display of almost all of the automated measurements available in the **Select Measrmts** side menus. This snapshot of measurements is taken on the waveform currently selected using the channel selection buttons.

As when displaying individual measurements, you must have a stable display of your signal, and that signal must have all the segments necessary for the measurement you want.

1. Press **Snapshot** (main) to pop up a snapshot of all available single waveform measurements. (See Figure 1-19).

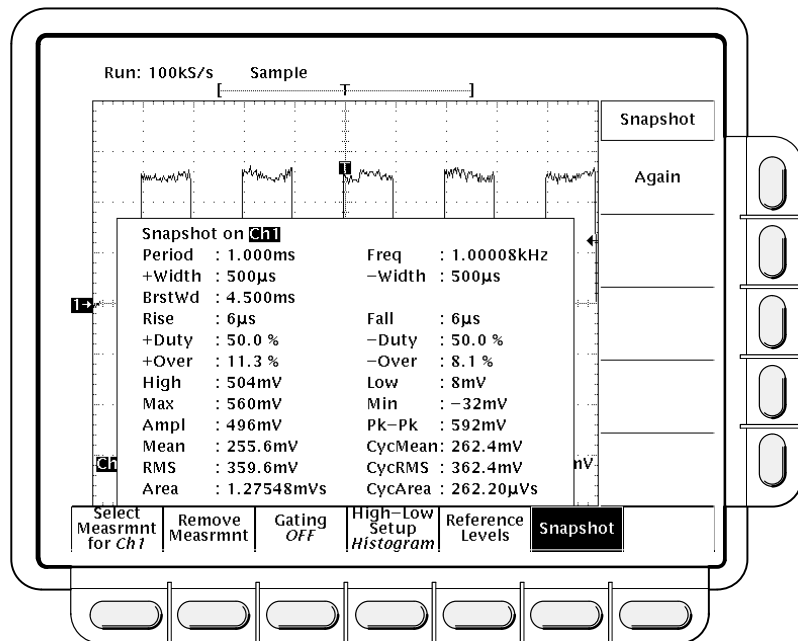

Figure 1-19: Snapshot of Channel 1

The snapshot display includes the notation **Ch 1**, meaning that the measurements displayed are taken on the channel 1 waveform. You take a snapshot of a waveform in another channel by first selecting that channel using the channel selection buttons.

Example 3: Automated Measurements

The snapshot measurements do not continuously update. Snapshot executes a one-time capture of all measurements and does not update those measurements unless it is performed again.

2. Press **Again** (side) to do another snapshot and update the snapshot measurements.
3. Press **Remove Measrmt** (main) to remove the snapshot display. (You can also press **CLEAR MENU**, but a new snapshot will be executed the next time you display the Measure menu.)

Example 4: Saving Setups

This example shows you how to save all the settings of the digitizing oscilloscope and how to recall the setup later to quickly re-establish the previously saved state. The oscilloscope provides several storage locations where you can save the setups. With the file system (optional on the TDS 620A & TDS 640A), you can also save setups to a floppy disk.

Besides being able to save several complete setups, the digitizing oscilloscope remembers all the parameter settings when you power it off. That feature lets you power on and continue where you left off without having to reconstruct the state of the digitizing oscilloscope.

Saving a Setup



First, you need to create an instrument setup you want to save. The next several steps establish a two-waveform display with a measurement on one waveform. The setup created is complex enough that you might prefer not to go through all these steps each time you want that display.

1. If you are not continuing from the previous example, follow the instructions on page 1-7 under the heading *Setting Up for the Examples*.
2. Press **SETUP** → **Recall Factory Setup** (main) → **OK Confirm Factory Init** (side).
3. Press → **AUTOSET**.
4. Press **MEASURE** → **Select Measrmt** (main) → **Frequency** (side). (Press the **–more–** side menu item if the **Frequency** selection does not appear in the side menu.)
5. Press **CH 2** → **CLEAR MENU**.
6. Press **SETUP** → **Save Current Setup** (main) to display the Setup main menu (see Figure 1-20).



Note that the setup locations shown in the side menu are labeled either **user** or **factory**. If you save your current setup in a location labeled **user**, you will overwrite the user setup previously stored there. If you work in a laboratory environment where several people share the digitizing oscilloscope, check with the other users before you overwrite their setup. Setup locations labeled **factory** have the factory setup stored as a default and can be used to store current setups without disturbing previously stored setups.

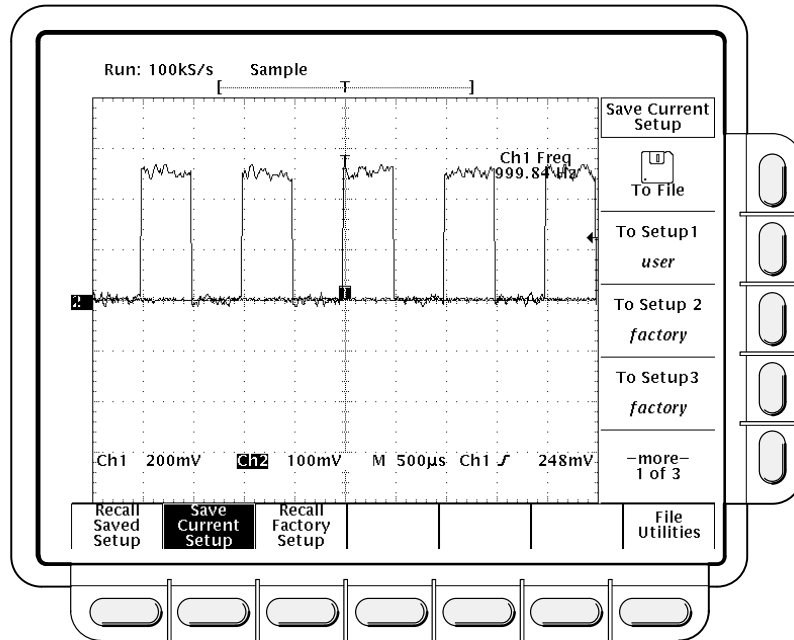

Figure 1-20: Save/Recall Setup Menu

7. Press one of the **To Setup** side menu buttons to store the current instrument settings into that setup location. Remember which setup location you selected for use later.

There are more setup locations than can be listed at one time in the side menu. The **–more–** side menu item gives you access to all the setup locations.

Once you have saved a particular setup, you can change the settings as you wish, knowing that you can come back to that setup at any time.



8. Press **MEASURE** → **Positive Width** (side) to add that measurement to the display.

Recalling a Setup

To recall the setup, Press **SETUP** → **Recall Saved Setup** (main) → **Recall Setup** (side) for the setup location you used in the last exercise. The positive width measurement is now removed from the display because you selected it after you saved the setup.

This completes the tutorial. You can restore the default settings by pressing **SETUP** → **Recall Factory Setup** (main) → **OK Confirm Factory Init** (side).

Example 4: Saving Setups

Overview

This section describes the basic concepts of operating the digitizing oscilloscope. Understanding the basic concepts of your digitizing oscilloscope will help you use it much more effectively.

The first part, *At a Glance*, quickly shows you how the oscilloscope is organized and gives some very general operating instructions. It also contains an overview of all the main menus. This part includes:

- Front Panel Map
- Rear Panel Map
- Display Map
- Basic Menu Operation
- Menu Map

The second part explains the following concepts:

- The **triggering** system, which establishes conditions for acquiring signals. Properly set, triggers can convert displays from unstable jumbles or blank screens into meaningful waveforms. See *Triggering* on page 2-13.
- The **acquisition** system, which converts analog data into digital form. See *Acquisition* on page 2-19.
- The **waveform scaling and positioning** system, which changes the dimensions of the waveform display. Scaling waveforms involves increasing or decreasing their displayed size. Positioning means moving them up, down, right, or left on the display. See *Scaling and Positioning Waveforms* on page 2-22.
- The **measurement** system, which provides numeric information on the displayed waveforms. You can use graticule, cursor, and automated measurements. See *Measurements* on page 2-26.

At the end of each topic, *For More Information* will point you to sources where more information can be found.

To explore these topics in more depth and to read about topics not covered in this section, see *Reference*. Page 3-1 lists the topics covered.

At a Glance

The *At a Glance* section contains illustrations of the display, the front and rear panels, and the menu system. These will help you understand and operate the digitizing oscilloscope. This section also contains a visual guide to using the menu system.

Front Panel Map — Left Side

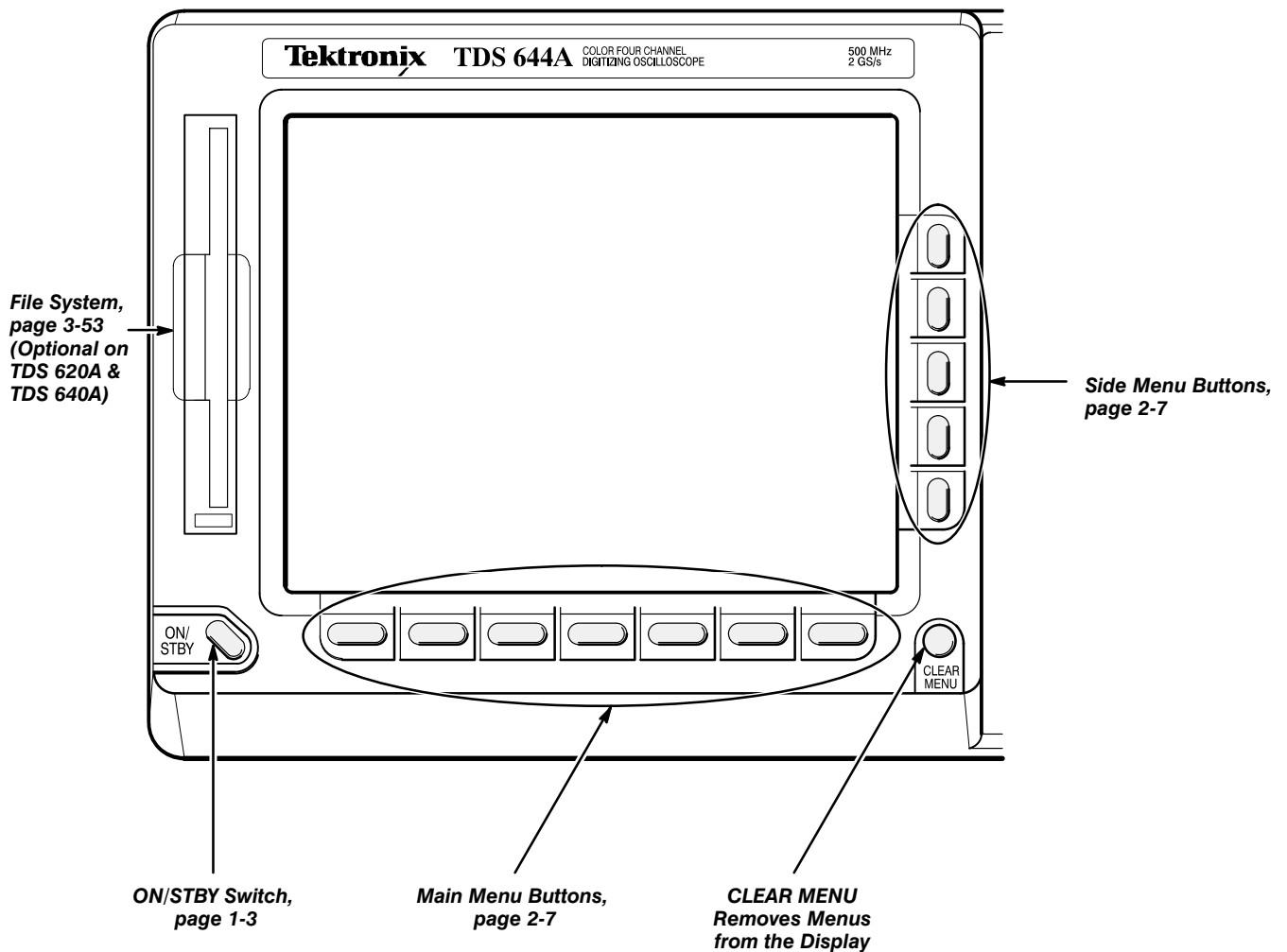

Front Panel Map — Right Side

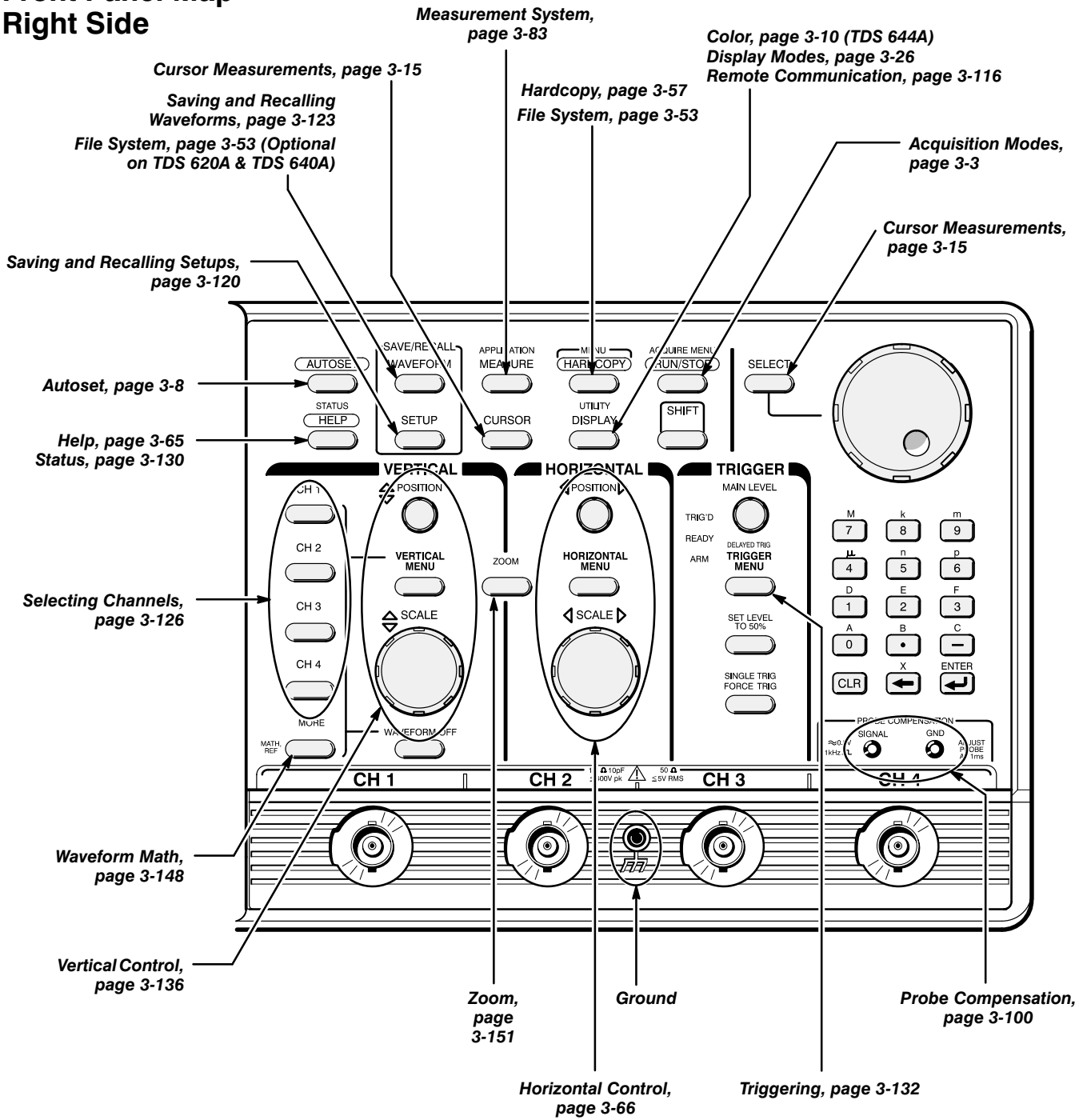

Rear Panel Map

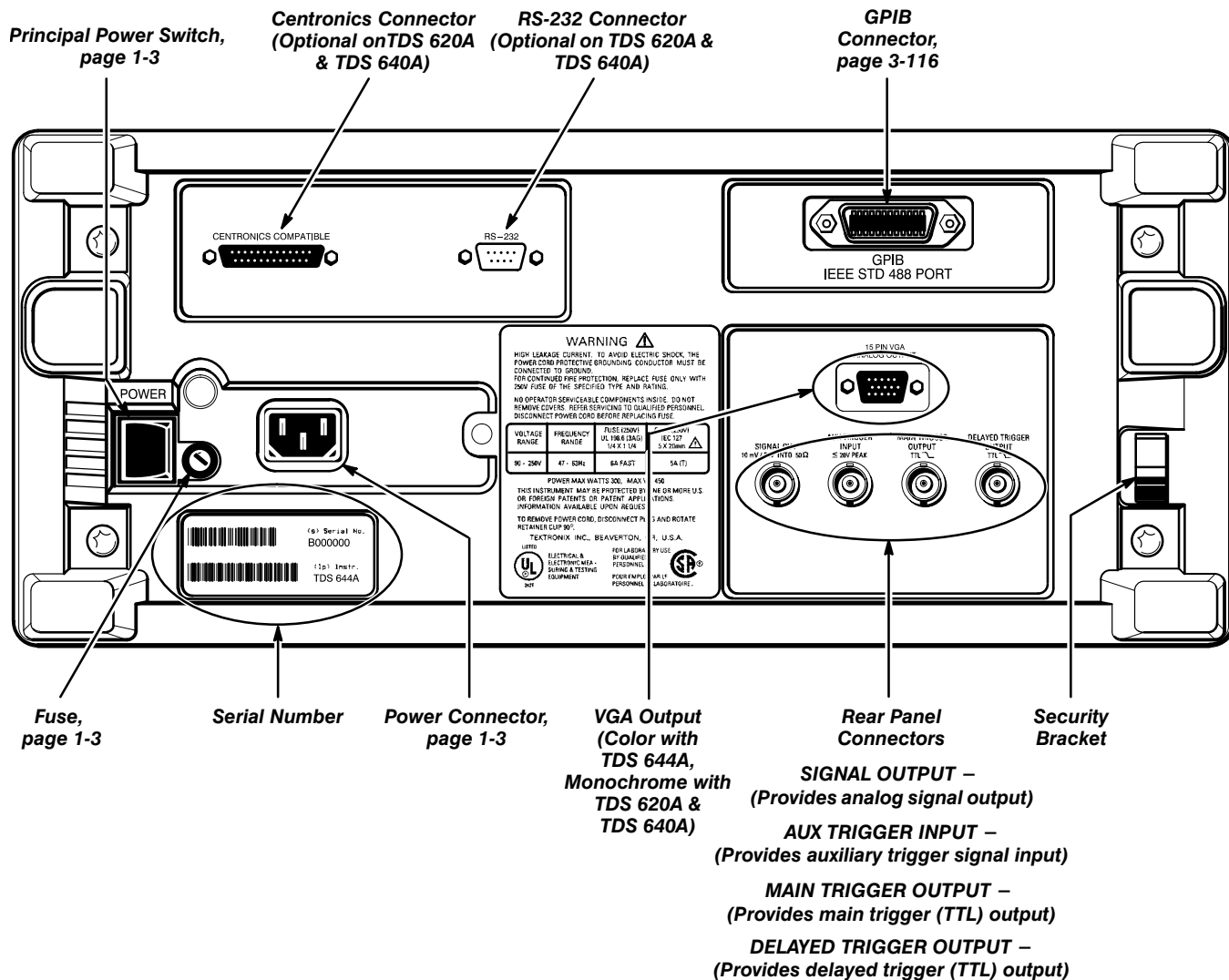

Display Map

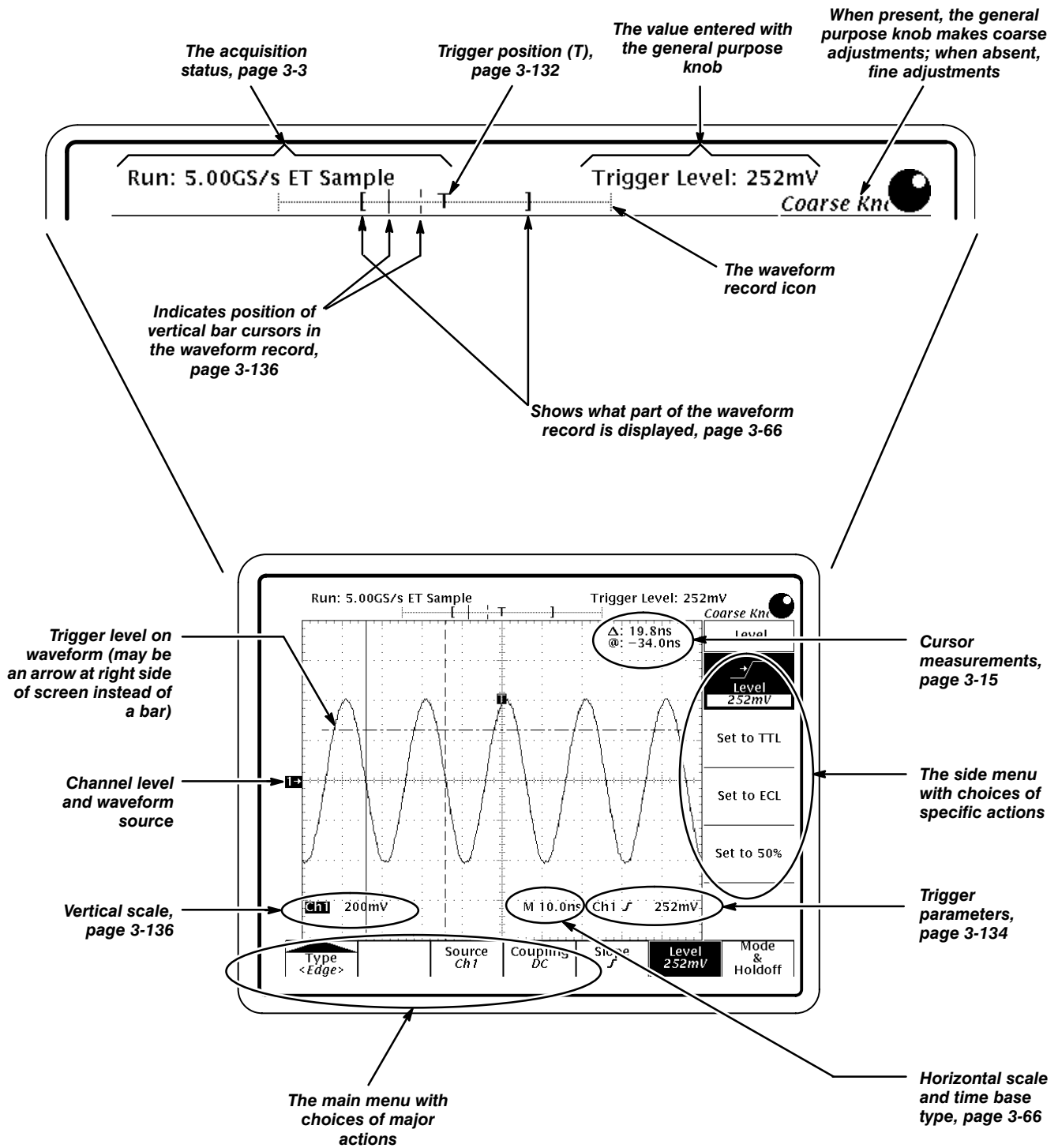

To Operate a Menu

1. Press front-panel menu button.
(Press **SHIFT** first if button label is blue)

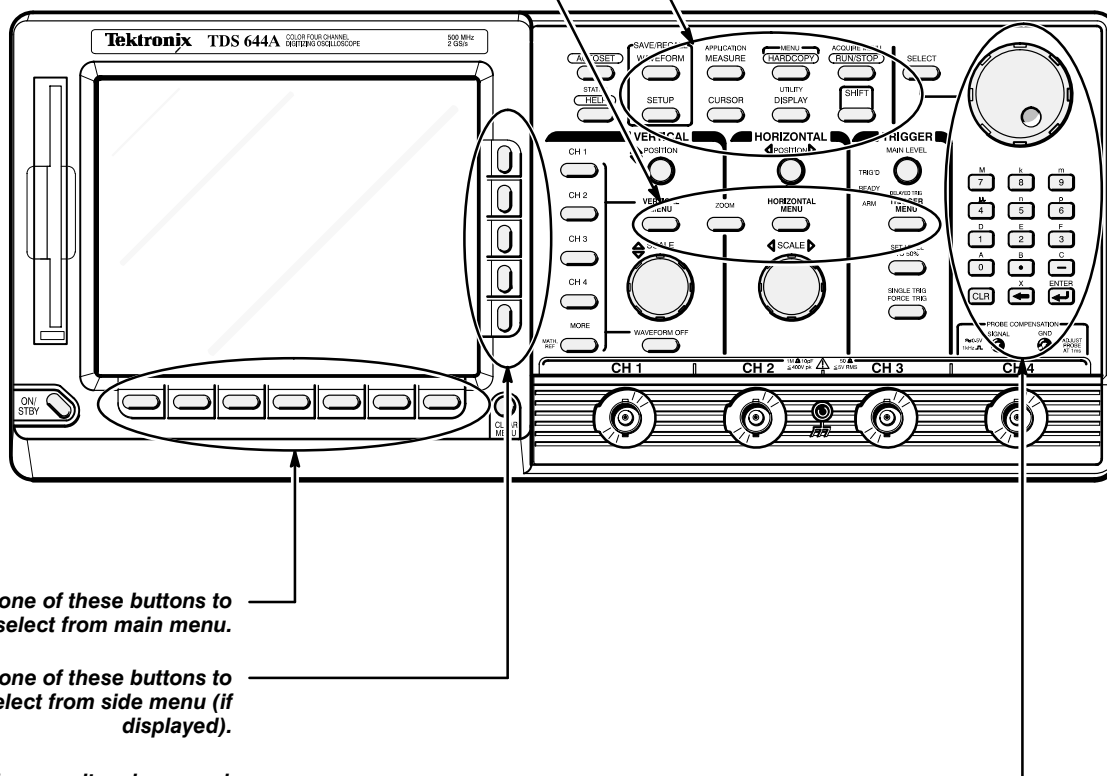

2. Press one of these buttons to select from main menu.

3. Press one of these buttons to select from side menu (if displayed).

4. If side menu item has an adjustable value (shown in reverse video), adjust it with the general purpose knob or keypad.

To Operate a Pop-Up Menu

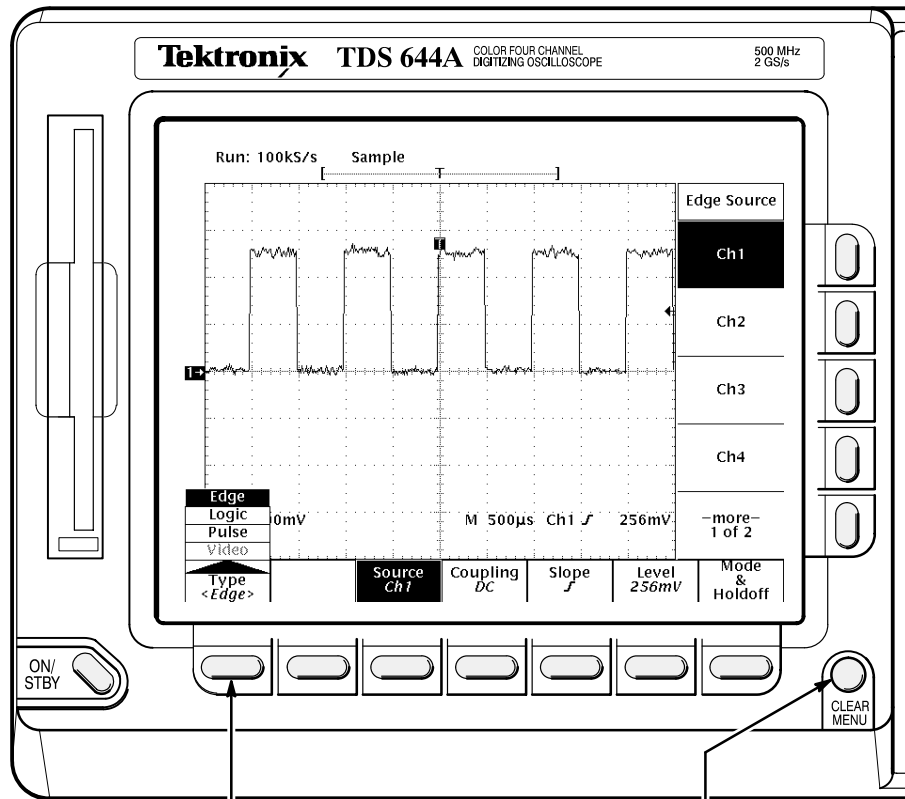

Press
to display pop-ups.

Press it again
to make selection.

Alternatively, press SHIFT
first to make selection in
the opposite direction.

A pop-up selection changes the
other main menu titles.

Press here to
remove menus
from screen.

Menu Map

Press these buttons:

To bring up these menus:

Acquire Menu
(see page 3-3)

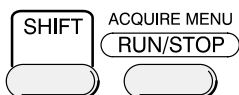

Mode <i>Sample</i>	Stop After <i>R/S button</i>		Limit Test Setup	Limit Test Sources	Create Limit Test Template	
-----------------------	---------------------------------	--	---------------------	-----------------------	----------------------------------	--

Application Menu
(see the Programmer
manual for more details)

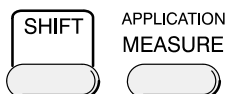

--	--	--	--	--	--	--

Cursor Menu
(see page 3-15)



Function <i>OFF</i>	Mode <i>Indep</i>	Time Units <i>seconds</i>	Amplitude Units <i>Base</i>			
------------------------	----------------------	---------------------------------	-----------------------------------	--	--	--

Delayed Trigger Menu
(see page 3-20)

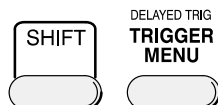

	Delay by <i>Time</i>	Source <i>Ch1</i>	Coupling <i>DC</i>	Slope <i>f</i>	Level <i>-30mV</i>	
--	-------------------------	----------------------	-----------------------	-------------------	-----------------------	--

Display Menu – Color
(TDS 644A) (see page 3-10)



Display <i>Color</i>	Settings <i><Color></i>	Palette <i>Normal</i>	Change Palette Colors	Map Math Colors	Map Reference Colors	Options	Restore Colors
-------------------------	----------------------------------	--------------------------	-----------------------------	-----------------------	----------------------------	---------	-------------------

Display Menu – Display
(TDS 644A) (see page 3-26)



Display <i>Color</i>	Settings <i><Display></i>	Style <i>Vectors</i>	Intensity	Readout Options	Filter <i>Sin(x)/x</i>	Graticule <i>Full</i>	Format <i>VT</i>
-------------------------	------------------------------------	-------------------------	-----------	--------------------	---------------------------	--------------------------	---------------------

Display Menu – Display
(TDS 620A & TDS 640A)
(see page 3-26)



Style <i>Vectors</i>	Intensity	Readout Options	Filter <i>Sin(x)/x</i>	Graticule <i>Full</i>	Format <i>VT</i>	
-------------------------	-----------	--------------------	---------------------------	--------------------------	---------------------	--

Horizontal Menu
(see page 3-66)



Time Base <i>Main</i>	Trigger Position <i>50%</i>	Record Length <i>500</i>	Horiz Scale <i>(/div)</i>	Horiz Pos		
--------------------------	-----------------------------------	--------------------------------	---------------------------------	--------------	--	--

Press these buttons:

To bring up these menus:

Hardcopy Menu
(TDS 620A & TDS 640A)
(see page 3-57)

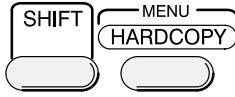

Format <i>Interleaf</i>	Layout <i>Portrait</i>	Port <i> GPIB</i>	Clear Spool			File Utilities
----------------------------	---------------------------	----------------------	----------------	--	--	-------------------

Hardcopy Menu
(TDS 644A)
(see page 3-57)

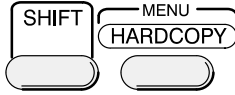

Format <i>Interleaf</i>	Layout <i>Portrait</i>	Palette <i>Hardcopy</i>	Port <i> GPIB</i>	Clear Spool		File Utilities
----------------------------	---------------------------	----------------------------	----------------------	----------------	--	-------------------

Main Trigger Menu – Edge
(see page 3-32)



Type <Edge>		Source <i>Ch1</i>	Coupling <i>DC</i>	Slope <i>f</i>	Level <i>-30mV</i>	Mode & Holdoff
----------------	--	----------------------	-----------------------	-------------------	-----------------------	----------------------

Main Trigger Menu – Logic
(see page 3-75)



Type <Logic>	Class <Pattern>	Define Inputs	Define Logic <i>AND</i>	Trigger When <i>Goes TRUE</i>	Set Thresholds	Mode & Holdoff
-----------------	--------------------	------------------	-------------------------------	-------------------------------------	-------------------	----------------------

Main Trigger Menu – Pulse
(see page 3-109)



Type <Pulse>	Class <Glitch>	Source <i>Ch1</i>	Polarity & Width	Glitch <i>Accept</i>	Level <i>240.0mV</i>	Mode & Holdoff
-----------------	-------------------	----------------------	------------------------	-------------------------	-------------------------	----------------------

Measure Menu
(see page 3-83)



Select Measrmt for <i>Ch1</i>	Remove Measrmt	Gating <i>OFF</i>	High-Low Setup <i>Histogram</i>	Reference Levels	Snapshot	
-------------------------------------	-------------------	----------------------	---------------------------------------	---------------------	----------	--

More Menu
(see page 3-148)



Math1 <i>Ch1+Ch2</i>	Math2 <i>Ch1-Ch2</i>	Math3 <i>inv(Ch1)</i>	Ref1	Ref2	Ref3	Ref4
-------------------------	-------------------------	--------------------------	------	------	------	------

Save/Recall Setup Menu
(see page 3-120)



Recall Saved Setup	Save Current Setup	Recall Factory Setup				File Utilities
--------------------------	--------------------------	----------------------------	--	--	--	-------------------

Save/Recall Waveform Menu
(see page 3-123)

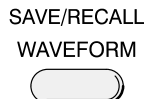

Recall Wfm to Ref	Save Wfm <i>Ch1</i>	Delete Refs				File Utilities
----------------------	------------------------	----------------	--	--	--	-------------------

Status Menu
(see page 3-130)

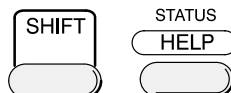

Status	Banner					
--------	--------	--	--	--	--	--

Press these buttons:

To bring up these menus:

Utility Menu – Calibration
(see page)

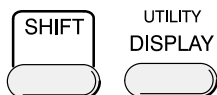

Config						
I/O						
Cal						
Diag/Err						
System <Cal>	Signal Path Pass	Voltage Reference Initialized	Frequency Response Initialized	Pulse Trigger Initialized		

Utility Menu – Config (see pages)

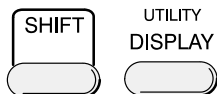

Config						
I/O						
Cal						
Diag/Err						
System <Config>	1ek Secure Erase Memory	Set Date & Time				

Utility Menu – Diagnostics
(see the Service manual)

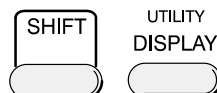

Config						
I/O						
Cal						
Diag/Err						
System <Diag/Err>	Area <All Areas>	Tests Select All	Execute	Loop Once		Error Log

Utility Menu – I/O – GPIB
(see page 3-116)

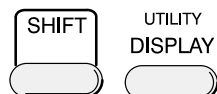

		GPIB RS232				
System <I/O>	Port <GPIB>	Configure Talk/Listen				

Utility Menu – I/O – RS232
(optional on TDS 620A & TDS 640A) (see page 3-116)

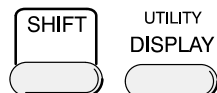

		GPIB RS232				
System <I/O>	Port <RS232>	Configure Hardcopy	Hardware Setup	Software Setup		

Vertical Channel Menu
(see page 3-136)



Coupling DC	Bandwidth Full	Fine Scale 10.0mV/div	Position 0 div	Offset 0 V		Cal Probe Initialized
-------------	----------------	-----------------------	----------------	------------	--	-----------------------

Zoom Menu
(see page 3-151)



Zoom
OFF
ON
Horizontal Lock Live
Reset Zoom Factors

Triggering

This section describes the edge trigger of the main trigger system and explores, in a general sense, the topic of triggering. This oscilloscope also has logic and pulse triggers in the main trigger system and a delayed trigger system. They are described in Section 3.

Triggers determine when the digitizing oscilloscope starts acquiring and displaying a waveform. They help create meaningful waveforms from unstable jumbles or blank screens (see Figure 2-1).

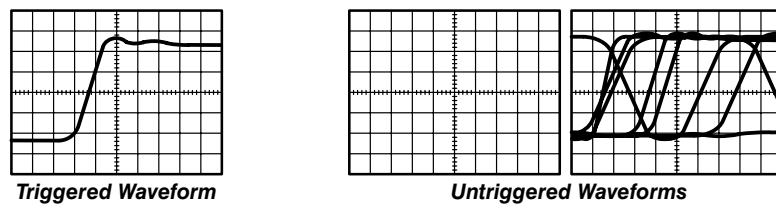

Figure 2-1: Triggered Versus Untriggered Displays

The trigger event establishes the time-zero point in the waveform record, and all points in the record are located in time with respect to that point. The digitizing oscilloscope continuously acquires and retains enough sample points to fill the pretrigger portion of the waveform record (that part of the waveform that is displayed *before*, or to the left of, the triggering event on screen).

When a trigger event occurs, the digitizing oscilloscope starts acquiring samples to build the posttrigger portion of the waveform record (displayed *after*, or to the right of, the trigger event). Once a trigger is recognized, the digitizing oscilloscope will not accept another trigger until the acquisition is complete.

The basic trigger is the edge trigger. An edge trigger event occurs when the trigger *source* (the signal that the trigger circuit monitors) passes through a specified voltage *level* in a specified direction (the trigger *slope*).

Trigger Sources

You can derive your trigger from various sources.

- **Input channels** — the most commonly used trigger source is any one of the four input channels. The channel you select as a trigger source will function whether it is displayed or not.

AC 

- **AC Line Voltage** — this trigger source is useful when you are looking at signals related to the power line frequency. Examples include devices such as lighting equipment and power supplies. Because the digitizing oscilloscope generates the trigger, you do not have to input a signal to create the trigger.
- **Auxiliary Trigger** — this trigger source is useful in digital design and repair. For example, you might want to trigger with an external clock or with a signal from another part of the circuit. To use the auxiliary trigger, connect the external triggering signal to the Auxiliary Trigger input connector on the oscilloscope rear panel.

Types

The digitizing oscilloscope provides three standard triggers for the main trigger system: edge, pulse, and logic. Option 05 provides a video trigger. The standard triggers are described in individual articles found in the *Reference* section. A brief definition of each type follows:



- **Edge** — the “basic” trigger. You can use it with both analog and digital test circuits. An edge trigger event occurs when the trigger *source* (the signal the trigger circuit is monitoring) passes through a specified voltage *level* in the specified direction (the trigger *slope*).



- **Pulse** — special trigger primarily used on digital circuits. Three classes of pulse triggers are *width*, *runt*, and *glitch*. Pulse triggering is available on the main trigger only.



- **Logic** — special trigger primarily used on digital logic circuits. You select Boolean operators for the trigger sources. Triggering occurs when the Boolean conditions are satisfied. There are two kinds of logic triggers, *state* and *pattern*. (Logic triggers are available on the main trigger system only.)



- **Video** — (with option 05) special trigger used on video circuits. It helps you investigate events that occur when a video signal generates a horizontal or vertical sync pulse. Supported classes of video triggers include *NTSC*, *PAL*, *SECAM*, and high definition TV signals.

Trigger Modes

The trigger mode determines how the oscilloscope behaves in the absence of a trigger event. The digitizing oscilloscope provides two different trigger modes, *normal* and *automatic*.

- **Normal** — this trigger mode lets the oscilloscope acquire a waveform only when it is triggered. If no trigger occurs, the oscilloscope will not acquire a waveform. (You can push **FORCE TRIGGER** to force the oscilloscope to make a single acquisition.)

- **Automatic** — this trigger mode (auto mode) lets the oscilloscope acquire a waveform even if a trigger does not occur. Auto mode uses a timer that starts after a trigger event occurs. If another trigger event is not detected before the timer times out, the oscilloscope forces a trigger anyway. The length of time it waits for a trigger event depends on the time base setting.

Be aware that auto mode, when forcing triggers in the absence of valid triggering events, does not sync the waveform on the display. In other words, successive acquisitions will not be triggered at the same point on the waveform; therefore, the waveform will appear to roll across the screen. Of course, if valid triggers occur the display will become stable on screen.

Since auto mode will force a trigger in the absence of one, auto mode is useful in observing signals where you are only concerned with monitoring amplitude level. Although the unsynced waveform may “roll” across the display, it will not freeze as it would in normal trigger mode. Monitoring of a power supply output is an example of such an application.

Holdoff

When a trigger event is recognized, the oscilloscope disables the trigger system until acquisition is complete. In addition, the trigger system remains disabled during the holdoff period that follows each acquisition. You can set holdoff time to help ensure a stable display.

For example, the trigger signal can be a complex waveform with many possible trigger points on it. Though the waveform is repetitive, a simple trigger might get you a series of patterns on the screen instead of the same pattern each time.

Digital pulse trains are good examples (see Figure 2-2). Each pulse looks like any other, so many possible trigger points exist. Not all of these will result in the same display. The holdoff period allows the digitizing oscilloscope to trigger on the correct edge, resulting in a stable display.

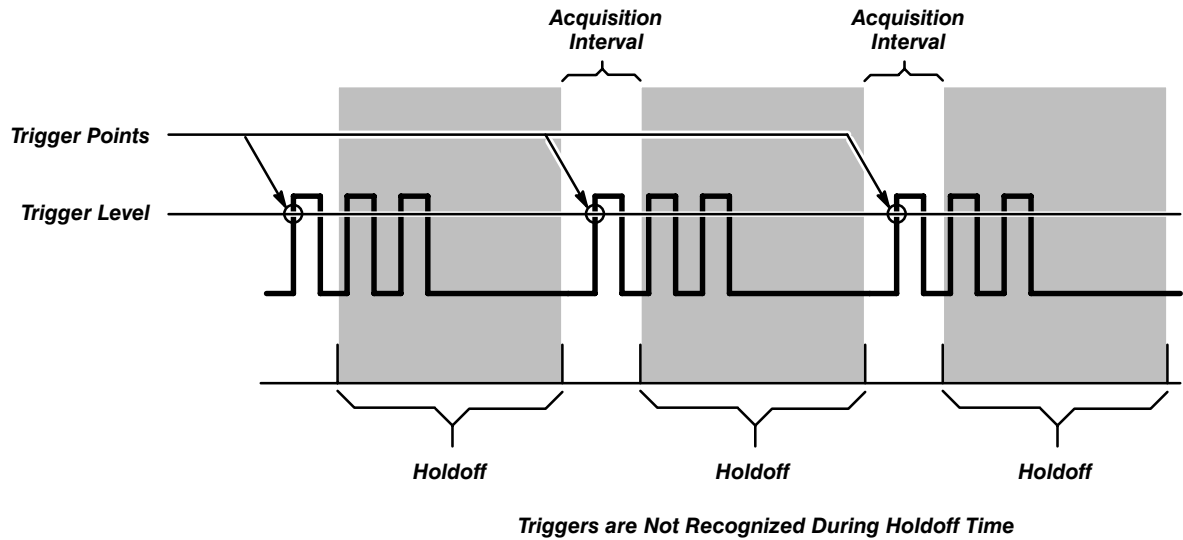

Figure 2-2: Trigger Holdoff Time Ensures Valid Triggering

Holdoff is settable from 0% (minimum holdoff available) to 100% (maximum available). To see how to set holdoff, see *Mode & Holdoff* on page 3-35. The minimum and maximum holdoff varies with the horizontal scale. See *Holdoff, Variable, Main Trigger* in the *TDS 620A, 640A, & 644A Performance Verification Manual*, Section 2 on *Specification, Typical Characteristics* for typical minimum and maximum values.

Coupling

Trigger coupling determines what part of the signal is passed to the trigger circuit. Available coupling types include AC, DC, Low Frequency Rejection, High Frequency Rejection, and Noise Rejection:

DC

- *DC coupling* passes all of the input signal. In other words, it passes both AC and DC components to the trigger circuit.

AC

- *AC coupling* passes only the alternating components of an input signal. (AC components above 10 Hz are passed if the source channel is in 1 M Ω coupling; above 200 kHz are passed in 50 Ω coupling.) It removes the DC components from the trigger signal.

- *High frequency rejection* removes the high frequency portion of the triggering signal. That allows only the low frequency components to pass on to the triggering system to start an acquisition. High frequency rejection attenuates signals above 30 kHz.

- *Low frequency rejection* does the opposite of high frequency rejection. Low frequency rejection attenuates signals below 80 kHz.

- *Noise Rejection* lowers trigger sensitivity. It requires additional signal amplitude for stable triggering, reducing the chance of falsely triggering on noise.

Trigger Position

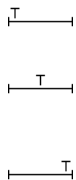

The adjustable *trigger position* defines where on the waveform record the trigger occurs. It lets you properly align and measure data within records. The part of the record that occurs *before* the trigger is the pretrigger portion. The part that occurs *after* the trigger is the posttrigger portion.

To help you visualize the trigger position setting, the top part of the display has an icon indicating where the trigger occurs in the waveform record. You select in the Horizontal menu what percentage of the waveform record will contain pretrigger information.

Many users find displaying pretrigger information a valuable troubleshooting technique. For example, if you are trying to find the cause of an unwanted glitch in your test circuit, it may prove valuable to trigger on the glitch and make the pretrigger period large enough to capture data before the glitch. By analyzing what happened before the glitch, you may uncover clues about the source of the glitch.

Slope and Level

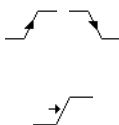

The slope control determines whether the oscilloscope finds the trigger point on the rising or the falling edge of a signal (see Figure 2-3).

You set trigger slope by selecting **Slope** in the Main Trigger menu and then selecting from the rising or falling slope icons in the side menu that appears.

The level control determines where on that edge the trigger point occurs (see Figure 2-3).

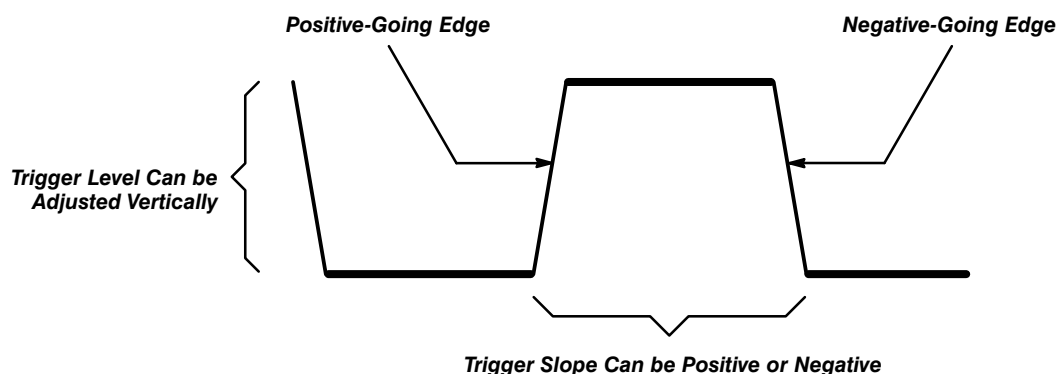

Figure 2-3: Slope and Level Controls Help Define the Trigger

The digitizing oscilloscope lets you set the main trigger level with the trigger **MAIN LEVEL** knob.

Delayed Trigger

As mentioned earlier in this section there is also a delayed trigger system that provides an edge trigger (no pulse or logic triggers). When using the delayed time base, you can also delay the acquisition of a waveform for a user-specified time or a user-specified number of delayed trigger events (or both) after a main trigger event.

For More Information

See *Delayed Triggering*, on page 3-20.

See *Edge Triggering*, on page 3-32.

See *Horizontal Controls*, on page 3-66.

See *Logic Triggering*, on page 3-75.

See *Pulse Triggering*, on page 3-109.

See *Triggering*, on page 3-132.

Acquisition

Acquisition is the process of sampling the analog input signal, converting it into digital data, and assembling it into a waveform record. The oscilloscope creates a digital representation of the input signal by sampling the voltage level of the signal at regular time intervals (Figure 2-4).

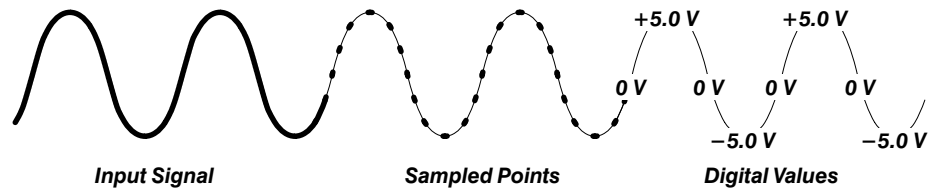

Figure 2-4: Acquisition: Input Analog Signal, Sample, and Digitize

The sampled points are stored in memory along with corresponding timing information. You can use this digital representation of the signal for display, measurements, or further processing.

You specify how the digitizing oscilloscope acquires data points and assembles them into the waveform record.

Sampling and Digitizing

The trigger point marks time zero in a waveform record. All record points before the trigger event make up the pretrigger portion of the the waveform record. Every record point after the trigger event is part of the posttrigger portion. All timing measurements in the waveform record are made relative to the trigger event.

Each time it takes a sample, the oscilloscope digitizer produces a numeric representation of the signal.

The digitizer can use the extra samples to perform additional processing, such as averaging or looking for minimum and maximum values.

The digitizing oscilloscope creates a waveform record containing a user-specified number of data points. Each record point represents a certain voltage level that occurs a determined amount of time from the trigger event.

Record Length

The number of points that make up the waveform record is defined by the record length. You can set the record length in the Horizontal menu. The digitizing oscilloscope provides record lengths of 500, 1000, and 2000 points.

Sampling

Sampling is the process of converting the analog input signal to digital for display and processing (see Figure 2-5).

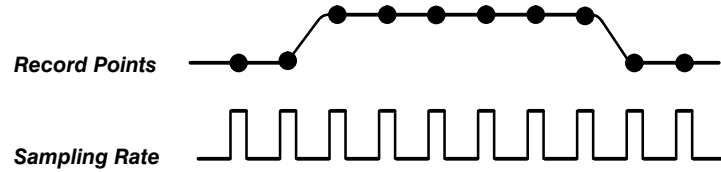

Figure 2-5: Real-Time Sampling

Interpolation

Turning the horizontal **SCALE** knob clockwise causes the scope to assign shorter time periods to the waveform record. The smaller the time period gets, the faster the oscilloscope needs to acquire record points to fill up the record.

If you turn the horizontal **SCALE** knob to a point that the time base is faster than 25 ns, the digitizing oscilloscope will not acquire enough samples for a complete waveform record. When that happens, the digitizing oscilloscope uses a process called interpolation to create the intervening points in the waveform record. There are two options for interpolation: linear or $\sin(x)/x$.

Linear interpolation computes record points between actual acquired samples by using a straight line fit. It assumes all the interpolated points fall in their appropriate point in time on that straight line. Linear interpolation is useful for many waveforms such as pulse trains.

$\sin(x)/x$ interpolation computes record points using a curve fit between the actual values acquired. It assumes all the interpolated points fall along that curve. That is particularly useful when acquiring more rounded waveforms such as sine waves. Actually, it is appropriate for general use, although it may introduce some overshoot or undershoot in signals with fast rise times.

NOTE

When using either type of interpolation, you may wish to set the display style so that the real samples are displayed intensified relative to the interpolated samples. The instructions under Display Style on page 3-26 explain how to turn on intensified samples.

Acquisition Modes

The digitizing oscilloscope supports three acquisition modes:

- *Sample*
- *Envelope*
- *Average*



Bandwidth

Bandwidth refers to the range of frequencies that an oscilloscope can acquire and display accurately (that is, with less than 3 dB attenuation).

You can set different bandwidths with the digitizing oscilloscope. Lower bandwidth settings let you eliminate the higher frequency components of a signal. The TDS 600A series offers **Full** (500 MHz), **100 MHz**, and **20 MHz** bandwidth settings.

Coupling

You can couple your input signal to the digitizing oscilloscope three ways. You can choose between AC, DC, or Ground (GND). You can also set the input impedance.

- | | |
|---|---|
| DC | ■ DC coupling shows both the AC and DC components of an input signal. |
| AC  | ■ AC coupling shows only the alternating components of an input signal. |
| GND  | ■ Ground (GND) coupling disconnects the input signal from the acquisition. |
| Ω | ■ Input impedance lets you select either 1 M Ω or 50 Ω impedance. |

NOTE

If you select 50 Ω impedance with AC coupling, the digitizing oscilloscope will not accurately display frequencies under 200 kHz.

Also, the optional P6205 probe automatically switches the input coupling to 50 Ω . This setting is appropriate for active probes like the P6205. If changing to a passive probe, or using any input signal that is not from a 50 Ω system, be sure to switch the channel input coupling to 1 M Ω .

For More Information

See *Scaling and Positioning Waveforms*, on page 2-22.

See *Acquisition Modes*, on page 3-3.

Scaling and Positioning Waveforms

Scaling and positioning waveforms means increasing or decreasing their displayed size and moving them up, down, right, and left on the display.

Two display icons, the channel reference indicator and the record view, help you quickly see the position of the waveform in the display (see Figure 2-6). The channel reference icon points to the ground of the waveform record when offset is set to 0 V. This is the point about which the waveform contracts or expands when the vertical scale is changed. The record view, at the top of the display, indicates where the trigger occurs and what part of the waveform record is displayed.

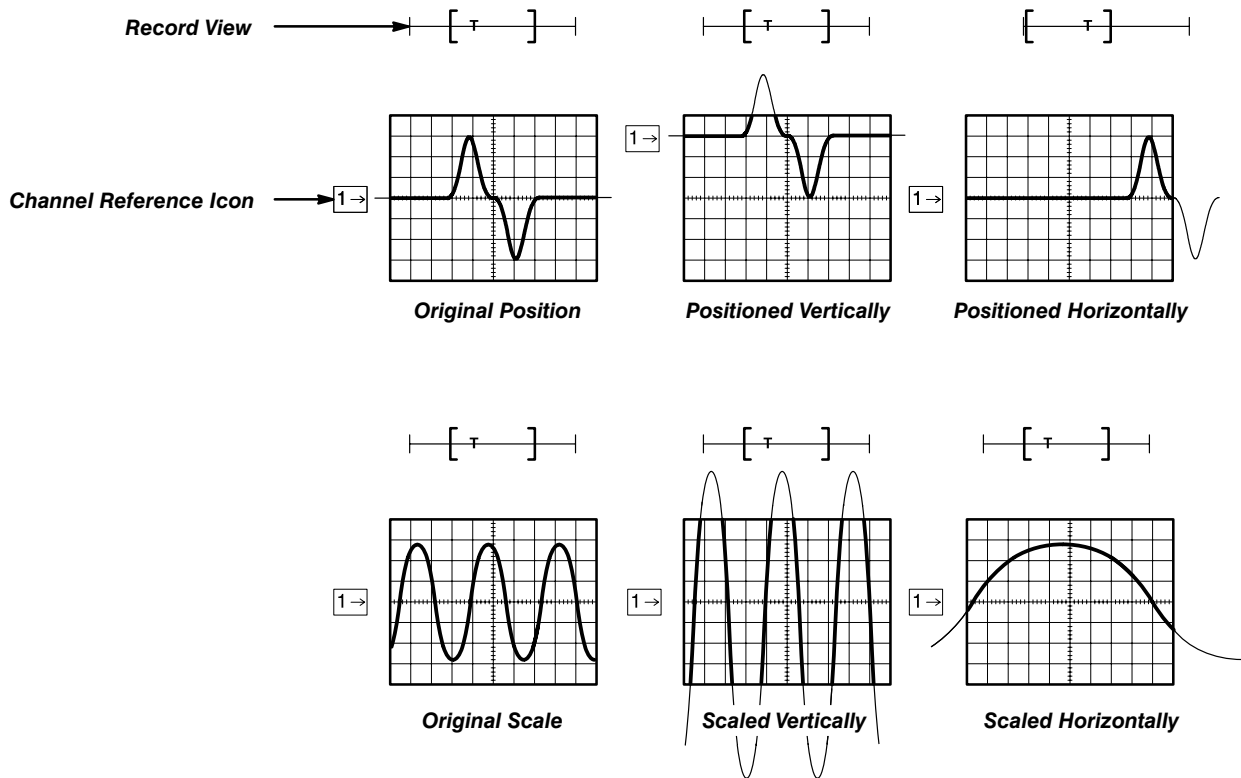

Figure 2-6: Scaling and Positioning

Vertical System

You can adjust the vertical position of the selected waveform by moving it up or down on the display. For example, when trying to compare multiple waveforms, you can put one above another and compare them, or you can overlay the two waveforms on top of each other. To move the selected waveform turn the vertical **POSITION** knob.

You can also alter the vertical scale. The digitizing oscilloscope shows the scale (in volts per division) for each active channel toward the bottom left of the display. As you turn the vertical **SCALE** knob clockwise, the value decreases resulting in higher resolution because you see a smaller part of the waveform. As you turn it counter-clockwise the scale increases allowing you to see more of the waveform but with lower resolution.

Besides using the position and scale knobs, you can set the vertical scale and position with exact numbers. You do that with the Vertical menu **Fine Scale** and **Position** selections and the general purpose knob and/or the keypad.

Offset

Vertical offset changes where the channel reference indicator is shown with respect to the graticule. Offset adds a voltage to the reference indicator without changing the scale. That feature allows you to move the waveform up and down over a large area without decreasing the resolution.

Offset is useful in cases where a waveform has a DC bias. One example is looking at a small ripple on a power supply output. You may be trying to look at a 100 mV ripple on top of a 15 V supply. The range available with offset can prove valuable as you try to move and scale the ripple to meet your needs.

Horizontal System

Adjusting the horizontal position of waveforms moves them right or left on the display. That is useful when the record length of the waveform is so large (greater than 500 points) that the digitizing oscilloscope cannot display the entire waveform record at one time. You can also adjust the scale of the waveform. For example, you might want to see just one cycle of a waveform to measure the overshoot on its rising edge.

You adjust the horizontal scale of the displayed waveform records using the horizontal **SCALE** knob and the horizontal position using the horizontal **POSITION** knob.

The digitizing oscilloscope shows the actual scale in the bottom right of the display. The scale readout shows the time per division used. Since all live waveforms use the same time base, the digitizing oscilloscope only displays one value for all the active channels.

Aliasing

When *aliasing* happens, you see a waveform with a frequency lower than the actual waveform being input or a waveform is not stable even though the light next to **TRIG'D** is lit. Aliasing occurs because the oscilloscope cannot sample the signal fast enough to construct an accurate waveform record (Figure 2-7).

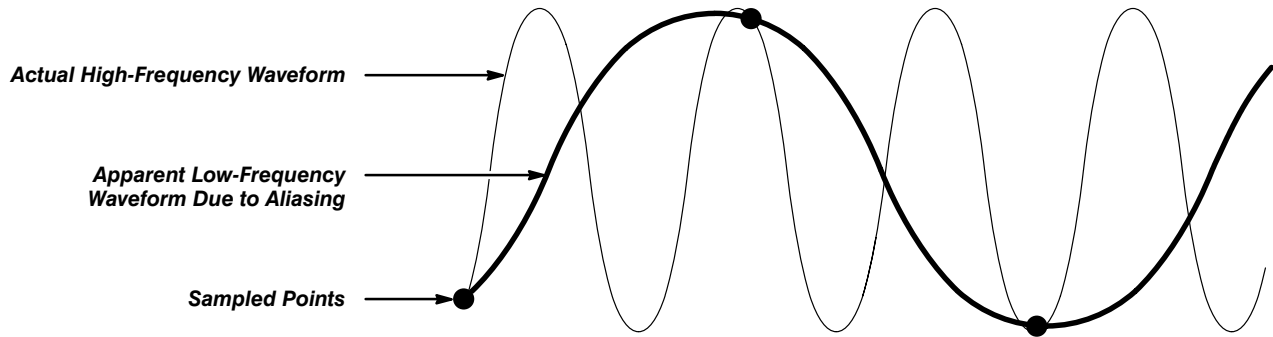

Figure 2-7: Aliasing

One simple way to check for aliasing is to slowly change the horizontal scale (time per division setting). If the shape of the displayed waveform changes drastically, you may have aliasing.

In order to represent a signal accurately and avoid aliasing, you must sample the signal more than twice as fast as the highest frequency component. For example, a signal with frequency components of 500 MHz would need to be sampled at a rate faster than 1 Gigasamples/second.

There are various ways to prevent aliasing. Try adjusting the horizontal scale, or simply press the **AUTOSET** button. You can also counteract some aliasing by changing the acquisition mode in the Acquisition menu. For example, if you are using the sample mode and suspect aliasing, you may want to change to the envelope mode. Since the envelope mode searches for multiple acquisitions with the highest and lowest values, it can detect faster signal components over time.

Delayed Time Base

You can set a main time base and a delayed time base. Each time base has its own trigger. There are two types of delayed time base acquisitions. Each type is based on its triggering relationship to the main time base. These are delayed runs after main and delay triggerable (after time, events, or both) acquisitions.

The delayed time base is useful in displaying events that follow other events. See *Triggering* on page 2-13 for more information on the delayed trigger.

Zoom

You can use zoom to see more detail without changing the acquired signal. When you press the **ZOOM** button, a portion of the waveform record can be expanded or compressed on the display, but the record points stay the same.

Zoom is very useful when you wish to temporarily expand a waveform to inspect small feature(s) on that waveform. For example, you might use zoom to temporarily expand the front corner of a pulse to inspect its aberrations. Use zoom to expand it horizontally and vertically. After you are finished, you can return to your original horizontal scale setting by pressing one menu button. (The zoom feature is also handy if you have acquired a waveform while using the fastest time per division and want to further expand the waveform horizontally.)

Autoset

Autoset lets you quickly obtain a stable waveform display. It automatically adjusts a wide variety of settings including vertical and horizontal scaling. Other settings affected include trigger coupling, type, position, slope, and mode and display intensities. *Autoset* on page 3-8 describes in detail what autoset does.

For More Information

See *Autoset*, on page 3-8.

See *Delayed Triggering*, on page 3-20.

See *Horizontal Control*, on page 3-66.

See *Vertical Control*, on page 3-136.

See *Zoom*, on page 3-151.

Measurements

The digitizing oscilloscope not only displays graphs of voltage versus time, it also can help you measure the displayed information (see Figure 2-8).

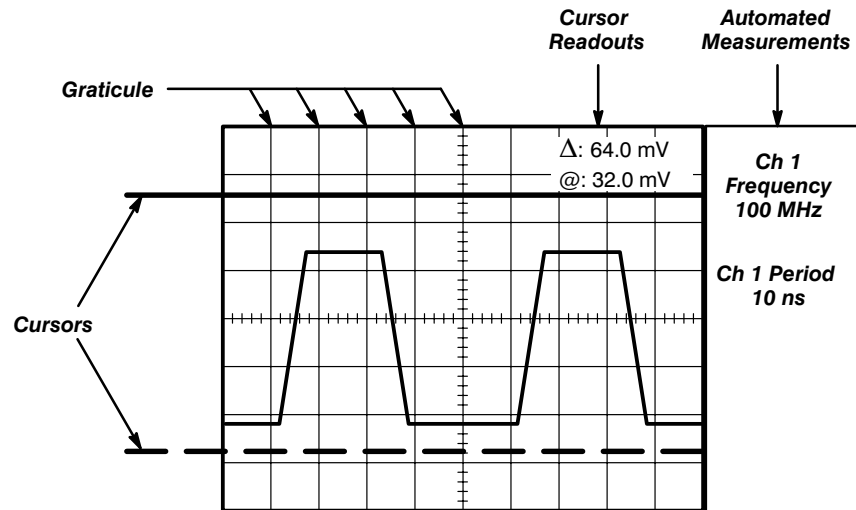

Figure 2-8: Graticule, Cursor and Automated Measurements

Measurement Sources

The oscilloscope provides three measurement classes. They are: automated, cursors, and graticule measurements.

Automated Measurements

You make automated measurements merely by pressing a few buttons. The digitizing oscilloscope does all the calculating for you. Because these measurements use the waveform record points, automated measurements are more accurate than cursor or graticule measurements.

Press the **MEASURE** button for the automated measurement menus. These menus let you make *amplitude* (typically in volts; sometimes in %), *time* (typically in seconds or hertz), and *area* (in volt-seconds) measurements. You can select and display up to four measurements at a time. (See Table 3-4 on page 3-83 for a list of all the automatic measurements and their definitions.)

You can make automated measurements on the entire waveform record or just on a specific part. The gating selection in the Measurement menu lets you use the vertical cursors to limit the measurement to a section of the waveform record.

The snapshot selection in the Measurement menu lets you display almost all of the measurements at once. You can read about snapshot under *Snapshot of Measurements*, on page 3-92.

Automated measurements use readouts to show measurement status. These readouts are updated as the oscilloscope acquires new data or if you change settings.

Cursor Measurements

Cursors are fast and easy-to-understand measurements. You take measurements by moving the cursors and reading their numeric values from the on screen readouts, which update as you adjust the position of the cursors.

Cursors appear in pairs. One cursor is *active* and the other *inactive*. You move the active cursor (the solid line) using the general purpose knob. The **SELECT** button lets you select (toggle) which cursor bar is active or inactive. The inactive cursor is a dashed line on the display.

To get the cursor menu, press the **CURSOR** button. There are three kinds of cursors available in that menu:

- *Horizontal bar cursors* measure vertical parameters (typically volts).
- *Vertical bar cursors* measure horizontal parameters (typically time or frequency).
- *Paired cursors* measure both vertical parameters (typically volts) and horizontal parameters (typically time or frequency).

There are also two modes for cursor operation available in the cursor menu — *independent* and *tracking* (See Figure 2-9).

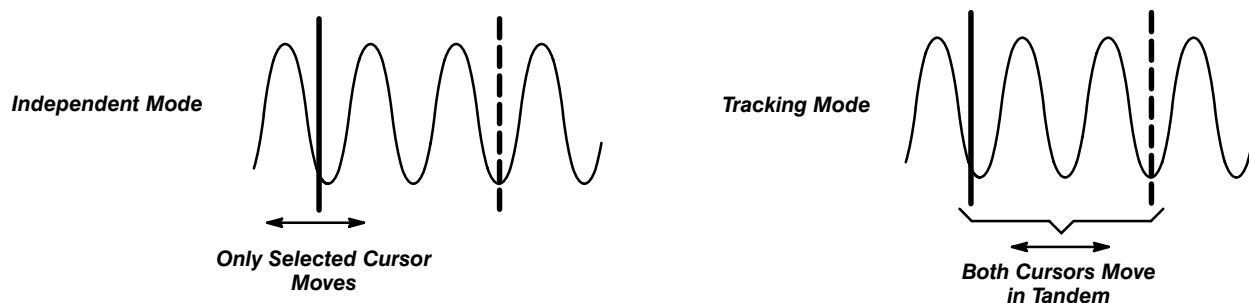

Figure 2-9: Cursor Modes

- *Independent mode* cursors operate as was earlier described; that is, you move *one* cursor at a time (the active cursor) using the general purpose knob, and you use the **SELECT** button to toggle which cursor is active.

- *Tracking mode* cursors operate in tandem: you move *both* cursors at the same time using the general purpose knob. To adjust the solid cursor relative to the dashed cursor, you push the **SELECT** button to suspend cursor tracking and use the general purpose knob to make the adjustment. A second push toggles the cursors back to tracking.

You can read more detailed information about how to use cursors in *Cursor Measurements*, beginning on page 3-15.

Graticule Measurements

Graticule measurements provide you with quick, visual estimates. For example, you might look at a waveform amplitude and say “it is a little more than 100 mV.”

You can perform simple measurements by counting the number of major and minor graticule divisions involved and multiplying by the scale factor.

For example, if you counted five major vertical graticule divisions between the minimum and maximum values of a waveform and knew you had a scale factor of 100 mV/division, then you could easily calculate your peak-to-peak voltage:

$$5 \text{ divisions} \times 100 \text{ mV/division} = 500 \text{ mV.}$$

NOTE

AUX 1 and AUX 2 (TDS 620A) can not be set to the volts per division needed to match video graticules.

When you select the NTSC graticule, the volts per division of all selected channels is set to 143 mV/div (152 mV/div for PAL) where the divisions are those of the conventional graticule, not the divisions of the video graticules. For NTSC, the actual grid lines represent 10 IRE, and for PAL the lines are 100 mV apart.

For More Information

See *Appendix B: Algorithms*, on page A-7, for details on how the digitizing oscilloscope calculates each automatic measurement.

See *Cursor Measurements*, on page 3-15, for more information on cursor measurements.

See *Measurement System*, on page 3-83, for more information on automatic measurements.

See *Tutorial Example 3: Automated Measurements*, on page 1-18, for more information on automatic measurements.

See *Waveform Math*, on page 3-148, for using cursors to measure math waveforms.

Overview

This section describes the details of operating the digitizing oscilloscope. It contains an alphabetical list of tasks you can perform with the digitizing oscilloscope. Use this section to answer specific questions about instrument operation. These tasks include:

- Acquisition Modes
- Autoset
- Color
- Cursor Measurements
- Delayed Triggering
- Display Modes
- Edge Triggering
- Fast Fourier Transforms
- File System
- Hardcopy
- Help
- Horizontal Control
- Limit Testing
- Logic Triggering
- Measurement System
- Probe Cal
- Probe Compensation
- Probe Selection
- Pulse Triggering
- Remote Communication
- Saving and Recalling Setups
- Saving and Recalling Waveforms
- Selecting Channels
- Signal Path Compensation
- Status
- Triggering
- Vertical Control
- Waveform Differentiation
- Waveform Integration
- Waveform Math
- Zoom

Many of these tasks list steps you perform to accomplish the task. You should read *Conventions* on page ii of *Welcome* before reading about these tasks.

Acquisition Modes

The acquisition system has several options for converting analog data into digital form. The Acquisition menu lets you determine the acquisition mode and how to start and stop acquisitions.

Description of Modes

The digitizing oscilloscope supports three acquisition modes.

- *Sample*
- *Envelope*
- *Average*

Sample mode operates in real-time on a single trigger event, provided the digitizing oscilloscope can acquire enough samples for each trigger event. Envelope and average modes operate on multiple acquisitions. The digitizing oscilloscope averages or envelopes several waveforms on a point-by-point basis.

Figure 3-1 illustrates the different modes and lists the benefits of each. It will help you select the appropriate mode for your application.

Sample Mode



In Sample mode, the oscilloscope creates a record point by saving the first sample (of perhaps many) during each acquisition interval. (An acquisition interval is the time covered by the waveform record divided by the record length.) This is the default mode.





	Takes One Acquisition per Trigger	Acquisition Mode	Waveform Drawn on CRT
Single Waveform Acquisition		 Sample	
		Uses first sample in each interval over single acquisition This is the default mode.	
Multiple Waveform Acquisitions	Takes a User-Specified Number of Acquisitions per Trigger	Acquisition Mode	Waveform Drawn on CRT
	Acquisition 1 2 3  Uses Sample Mode for Each Acquisition	 Envelope Finds highest and lowest record points over many acquisitions Use to reveal variations in the signal across time.	
 Uses Sample Mode for Each Acquisition	 Average Calculates average value for each record point over many acquisitions Use to reduce apparent noise in a repetitive signal.		

Figure 3-1: How the Acquisition Modes Work

Envelope Mode

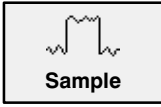
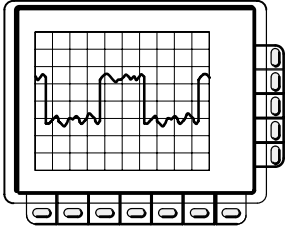

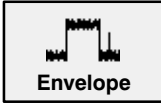
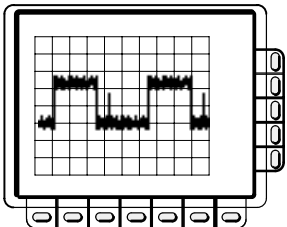
Envelope mode lets you acquire and display a waveform record that shows the extremes in variation over several acquisitions. You specify the number of acquisitions over which to accumulate the data. The oscilloscope saves the highest and lowest values in two adjacent intervals. Envelope mode gathers peaks over many trigger events.

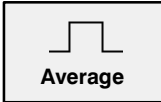
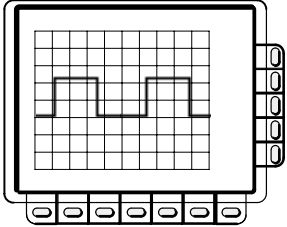
After each trigger event, the oscilloscope acquires data and then compares the min/max values from the current acquisition with those stored from previous acquisitions. The final display shows the most extreme values for all the acquisitions for each point in the waveform record.

Average Mode



Average mode lets you acquire and display a waveform record that is the averaged result of several acquisitions. This mode reduces random noise. The oscilloscope acquires data after each trigger event using Sample mode. It then averages the record point from the current acquisition with those stored from previous acquisitions.

Acquisition Readout

The acquisition readout at the top of the display (Figure 3-2) shows the state of the acquisition system (running or stopped). The “running” state shows the sample rate and acquisition mode. The “stopped” state shows the number of acquisitions acquired since the last stop or major change.

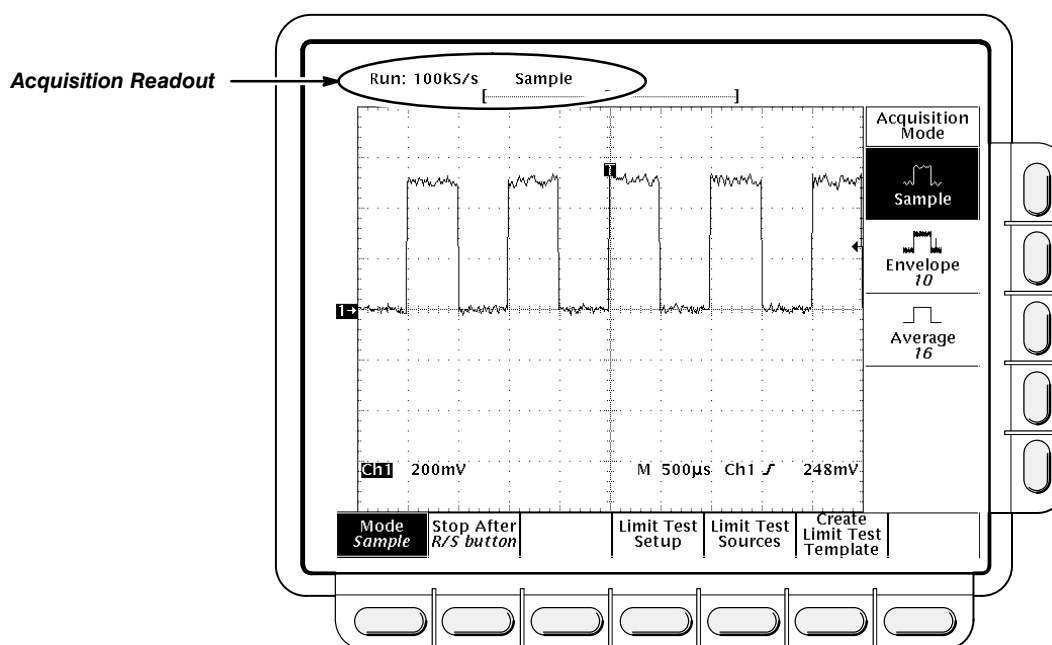

Figure 3-2: Acquisition Menu and Readout

Operation

To bring up the acquisition menu (Figure 3-2) press **SHIFT ACQUIRE MENU**.

Acquisition Mode

To choose how the digitizing oscilloscope will create points in the waveform record:

Press **SHIFT ACQUIRE MENU** → **Mode** (main) → **Sample, Envelope, or Average** (side).

When you select **Envelope** or **Average**, you can enter the number of waveform records to be enveloped or averaged using the keypad or the general purpose knob.

NOTE

The digitizing oscilloscope interpolates between samples at horizontal scale settings faster than 25 ns/div. See Sampling and Digitizing on page 2-19 for a discussion of interpolation.

Stop After

You can choose to acquire exactly one waveform sequence or to acquire waveforms continuously under manual control.

Press **SHIFT ACQUIRE MENU** → **Stop After** (main) → **RUN/STOP button only**, **Single Acquisition Sequence**, or **Limit Test Condition Met** (side) (see Figure 3-3).

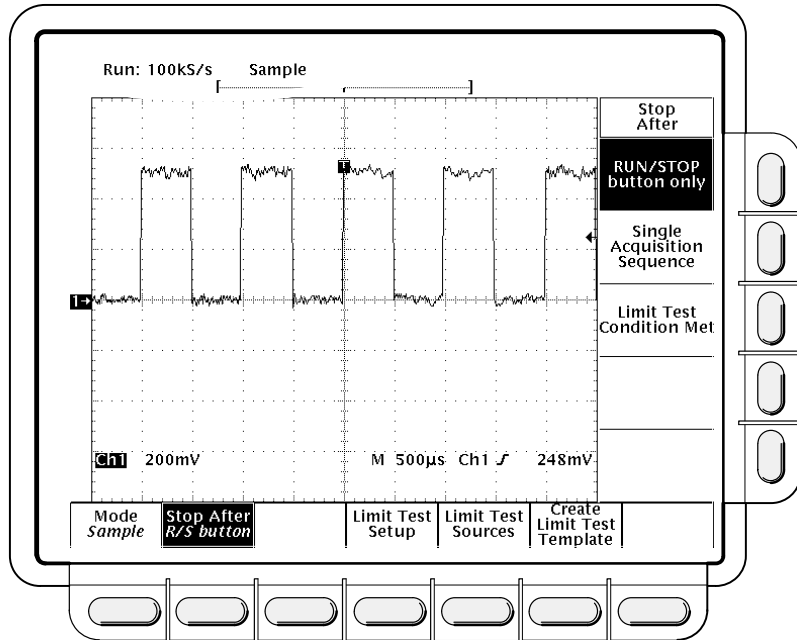

Figure 3-3: Acquire Menu — Stop After

- **RUN/STOP button only** (side) lets you start or stop acquisitions by toggling the **RUN/STOP** button. Pressing the **RUN/STOP** button once will stop the acquisitions. The upper left hand corner in the display will say **Stopped** and show the number of acquisitions. If you press the button again, the digitizing oscilloscope will resume taking acquisitions.

- Press **Single Acquisition Sequence** (side). That selection lets you run a single sequence of acquisitions by pressing the **RUN/STOP** button. In Sample mode, the digitizing oscilloscope will acquire a waveform record with the first valid trigger event and stop.

In Envelope or Average mode, the digitizing oscilloscope will make the specified number of acquisitions to complete the averaging or enveloping task.

Hint: To quickly select Single Acquisition Sequence without displaying the Acquire and Stop After menus, press **SHIFT FORCE TRIG**. Now the **RUN/STOP** button operates as just described. (You still must display the Acquire menu and then the Stop After menu to leave Single Acquisition Sequence operation.)

- **Limit Test Condition Met** (side) lets you acquire waveforms until waveform data exceeds the limits specified in the limit test. Then acquisition stops. At that point, you can also specify other actions for the oscilloscope to take, using the selections available in the **Limit Test Setup** main menu.

NOTE

*In order for the digitizing oscilloscope to stop an acquisition when limit test conditions have been met, limit testing must be turned **ON**, using the **Limit Test Setup** main menu.*

Setting up limit testing requires several more steps. You can create the template waveform against which to compare incoming waveforms, using the **Create Limit Test Template** main menu item. You can then specify that the comparison is to be made, and the channel to compare against the template, using the **Limit Test Sources** main menu item.

For More Information

See *Acquisition*, on page 2-19.

See *Limit Testing*, on page 3-70.

Autoset

The autoset function lets you quickly obtain and display a stable waveform of usable size. Autoset automatically sets up the front panel controls based on the characteristics of the input signal. It is much faster and easier than a manual control-by-control setup.

Autoset makes adjustments in these areas:

- Acquisition
- Display
- Horizontal
- Trigger
- Vertical

NOTE

Autoset may change vertical position in order to position the waveform appropriately. It always sets vertical offset to 0 V.

Operation

1. Press the Channel Selection button (such as **CH 1**) corresponding to your input channel to make it active.
2. Press **AUTOSET**.

If you use autoset when one or more channels are displayed, the digitizing oscilloscope selects the lowest numbered channel for horizontal scaling and triggering. Vertically, all channels in use are individually scaled.

If you use autoset when no channels are displayed, the digitizing oscilloscope will turn on channel one (**CH 1**) and scale it.

Autoset Defaults

Table 3-1 on the following page lists the autoset defaults.

Table 3-1: Autoset Defaults

Control	Changed by Autoset to
Selected channel	Numerically lowest of the displayed channels
Acquire Mode	Sample
Acquire Stop After	RUN/STOP button only
Display Style	Vectors
Display Intensity — Overall (TDS 640A & TDS 620A)	If less than 50%, set to 75%
Display Format	YT
Horizontal Position	Centered within the graticule window
Horizontal Scale	As determined by the signal frequency
Horizontal Time Base	Main Only
Horizontal Record Length	Unchanged
Limit Test	Off
Trigger Position	Unchanged
Trigger Type	Edge
Trigger Source	Numerically lowest of the displayed channels (the selected channel)
Trigger Level	Midpoint of data for the trigger source
Trigger Slope	Positive
Trigger Coupling	DC
Trigger Holdoff	0
Vertical Scale	As determined by the signal level
Vertical Coupling	DC unless AC was previously set. AC remains unchanged.
Vertical Bandwidth	Full
Vertical Offset	0 volts
Zoom	Off

Color (TDS 644A)

The TDS 644A can display information in different colors. The Color menu lets you choose palettes of colors and decide what colors to assign to what pieces of information.

Operation

To bring up the Color menu:

1. Press **DISPLAY** to show the Display menu.
2. Press **Settings** in the main menu until you select **Color** from the pop-up menu (see Figure 3-4).

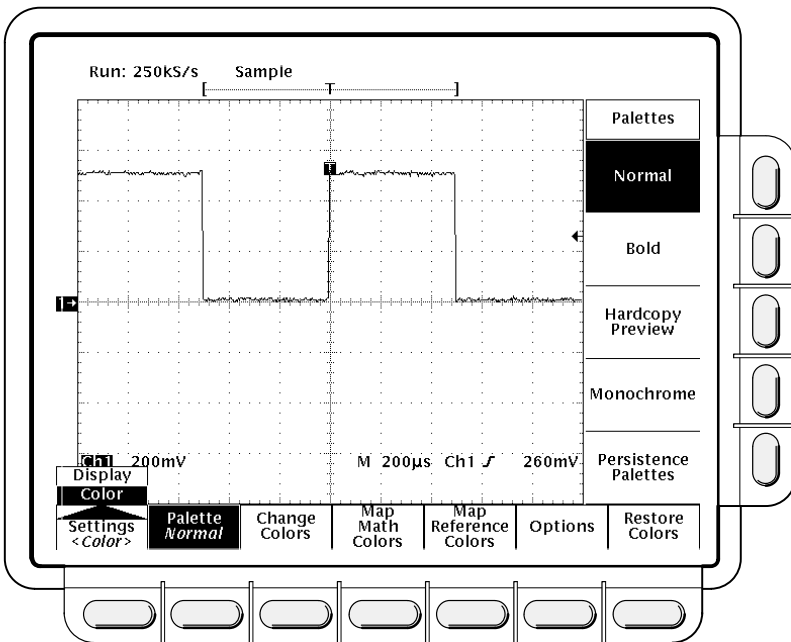

Figure 3-4: Display Menu — Setting

Color lets you alter color settings for various display components such as waveforms and text. **Display** lets you adjust the style, intensity level, graticule, and format features. For more information on display, see *Display* on page 3-26.

Choose Palette

You can choose a palette of 13 colors from a menu of pre-set palettes.

1. Choose the starting palette by selecting **Palette** from the main menu.
2. Select one of the available palettes in the side menu. Choose from **Normal**, **Bold**, **Hardcopy Preview** or **Monochrome**.
3. If you are using a persistence display and wish to vary the color of each point depending on its persistence, choose **Persistence Palettes**. Then choose **Temperature**, **Spectral**, or **Gray Scale** from the resulting side menu. Choose **View Palette** to preview your selection on the display. Press **Persistence Palette** to quit preview mode. Press **Clear Menu** to return to the Palette menu.

NOTE

Use at higher room temperatures or with higher intensity display formats, such as the white fields in the Hardcopy Preview palette, can temporarily degrade display quality.

You can select the Hardcopy Preview palette when using certain color hardcopy formats. The default colors in the hardcopy preview palette comprise a white background and fully saturated primary colors which generally produce the best result.

Change Palette Colors

You can change the current palette colors. You do this by selecting a color and varying its hue, lightness, and saturation. Hue is the wavelength of light reflected from the surface. It varies continuously along the color spectrum as produced by a rainbow. Lightness refers to the amount of light reflected from the surface. It varies from black, to the nominal color, to white. Saturation is the intensity of color. Completely desaturated color is gray. Completely saturated color of any hue is that color at its most intense level.

1. Select the main menu **Change Colors** item (see Figure 3-5).

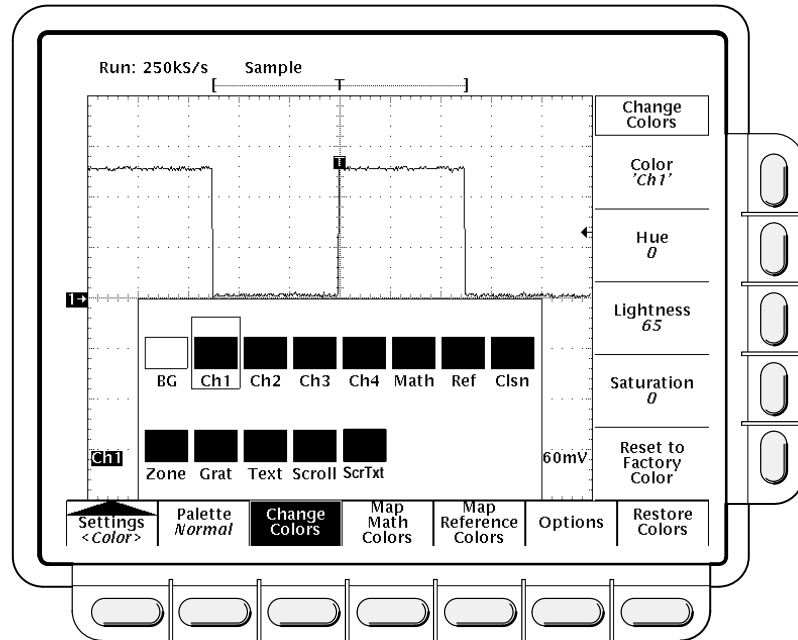

Figure 3-5: Display Menu — Palette Colors

2. Select one of the 13 colors by pressing (repeatedly) **Color** in the side menu.
3. If you want to use the factory default for this color, press the side menu **Reset to Factory Color**.
4. Choose **Hue** from the side menu and use the general purpose knob or keypad to select the desired hue. Values range from 0 to 359. Sample values are: 0 = blue, 60 = magenta, 120 = red, 180 = yellow, 240 = green, and 360 = cyan.
5. Choose **Lightness** from the side menu and use the general purpose knob or keypad to select the lightness you desire. A value of 0 results in black. A value of 50 provides the nominal color. A value of 100 results in white.
6. Choose **Saturation** from the side menu and use the general purpose knob or keypad to select the saturation you desire. A value of 100 provides a pure color. A value of 0 provides gray.

Set Math Waveform Color

To define math waveform colors:

1. Choose to define math waveform colors by selecting the main menu **Map Math** item.
2. Select one of the three math waveforms by pressing **Math** in the side menu.

3. If you want to assign the selected math waveform to a specific color, press **Color** and cycle through the choices.
4. If you want the selected math waveform to be the same color as the waveform it is based on, select **Color Matches Contents**. If the math waveform is based on dual waveforms, the math waveform will use the color of the first constituent waveform.

To return to the factory defaults, select **Reset to Factory Color**.

Set Reference Waveform Color

To define reference waveform colors:

1. Press **Map Reference** in the main menu (see Figure 3-6).
2. Select one of the four reference waveforms by pressing **Ref** in the side menu.
3. To assign the selected reference waveform to a specific color, press (repeatedly) **Color** and choose the value.
4. To make the selected reference waveform the same color as the waveform it is based on, select **Color Matches Contents**.

To return to the factory defaults, select **Reset to Factory Color**.

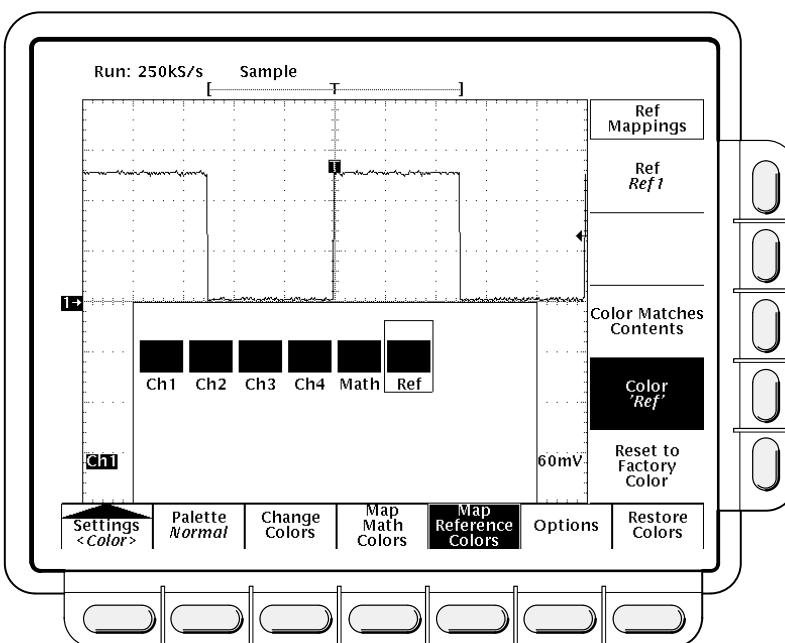

Figure 3-6: Display Menu — Map Reference Colors

Select Options

To define what color to show where a waveform crosses another waveform:

1. Press the **Options** main menu item.
2. Select that you wish to use a special color to mark collision zones by toggling **Collision Contrast** in the side menu to **ON**.

Restore Colors

To restore colors to their factory default settings:

1. Press the main menu **Restore Colors** item (see Figure 3-7).
2. Select what you wish to restore by pressing **Reset Current Palette To Factory**, **Reset All Palettes To Factory** or **Reset All Mappings To Factory** in the side menu.

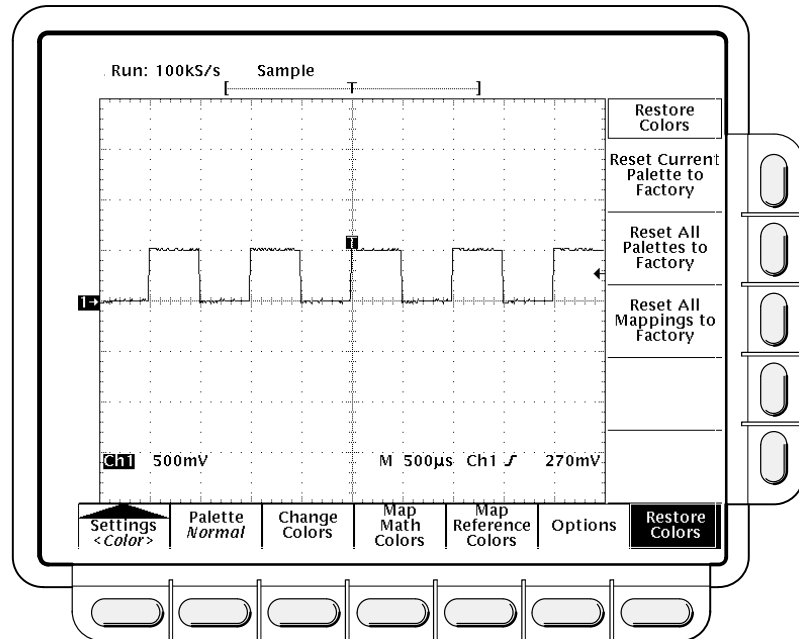

Figure 3-7: Display Menu — Restore Colors

**For More
Information**

See *Display Modes*, on page 3-26.

Cursor Measurements

Use the cursors to measure the difference (either in time or voltage) between two locations in a waveform record.

Description

Cursors are made up of two markers that you position with the general purpose knob. You move one cursor independently or both cursors in tandem, depending on the cursor mode. As you position the cursors, readouts on the display report measurement information.

There are three cursor types: *horizontal bar*, *vertical bar*, and *paired* (Figure 3-8).

Horizontal bar cursors measure vertical parameters (typically volts).

Vertical bar cursors measure horizontal parameters (typically time or frequency).

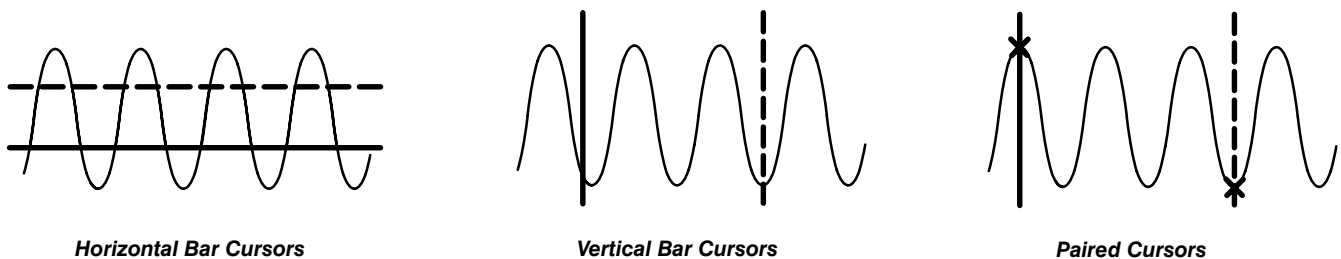

Figure 3-8: Cursor Types

Paired cursors measure both vertical parameters (typically volts) and horizontal parameters (typically time) simultaneously.

Look at Figure 3-8. Note that each of the two paired cursors has a long vertical bar paired with an X. The Xs measure vertical parameters (typically volts); the long vertical bars measure horizontal parameters (typically time or frequency). (See *Cursor Readouts* on page 3-16 for more information.)

NOTE

When cursors measure certain math waveforms, the measurement may not be of time, frequency, or voltage. Cursor measurement of those math waveforms that are not of time, frequency, or voltage is described in *Waveform Math*, which begins on page 3-148.

There are two cursor modes: *independent* and *tracking* (see Figure 3-9).

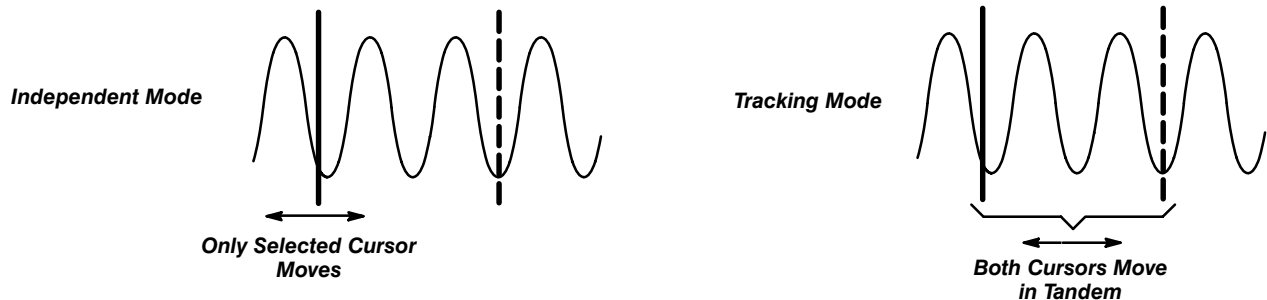

Figure 3-9: Cursor Modes

In independent mode you move only one cursor at a time using the general purpose knob. The active, or selected, cursor is a solid line. Press **SELECT** to change which cursor is selected.

In tracking mode you normally move both cursors in tandem using the general purpose knob. The two cursors remain a fixed distance (time or voltage) from each other. Press **SELECT** to temporarily suspend cursor tracking. You can then use the general purpose knob to adjust the distance of the solid cursor relative to the dashed cursor. A second push toggles the cursors back to tracking.

Cursor Readouts

The cursor readout shows the absolute location of the selected cursor and the difference between the selected and non-selected cursor. The readouts differ depending on whether you are using **H Bars** or **V Bars**.

- **H Bars:** the value after Δ shows the voltage difference between the cursors. The value after @ shows the voltage of the selected cursor relative to ground (see Figure 3-10). With the video trigger option, you can also display the voltage in IRE units.
- **V Bars:** the value after Δ shows the time (or frequency) difference between the cursors. The value after @ shows the time (frequency) of the selected cursor relative to the trigger point. With the video trigger option, you can also display the line number.

In FastFrame mode, the @ shows the time position of the selected cursor relative to the trigger point of the frame that the selected cursor is in. The Δ shows the time difference between the two cursors only if both cursors are in the same frame.

- **Paired:** the value after one Δ shows the voltage difference between the two Xs; the other Δ shows the time (or frequency) difference between the two long vertical bars. The value after @ shows the voltage at the X of the selected cursor relative to ground (see Figure 3-11).

In FastFrame mode, the Δ shows the time difference between the two cursors only if both cursors are in the same frame.

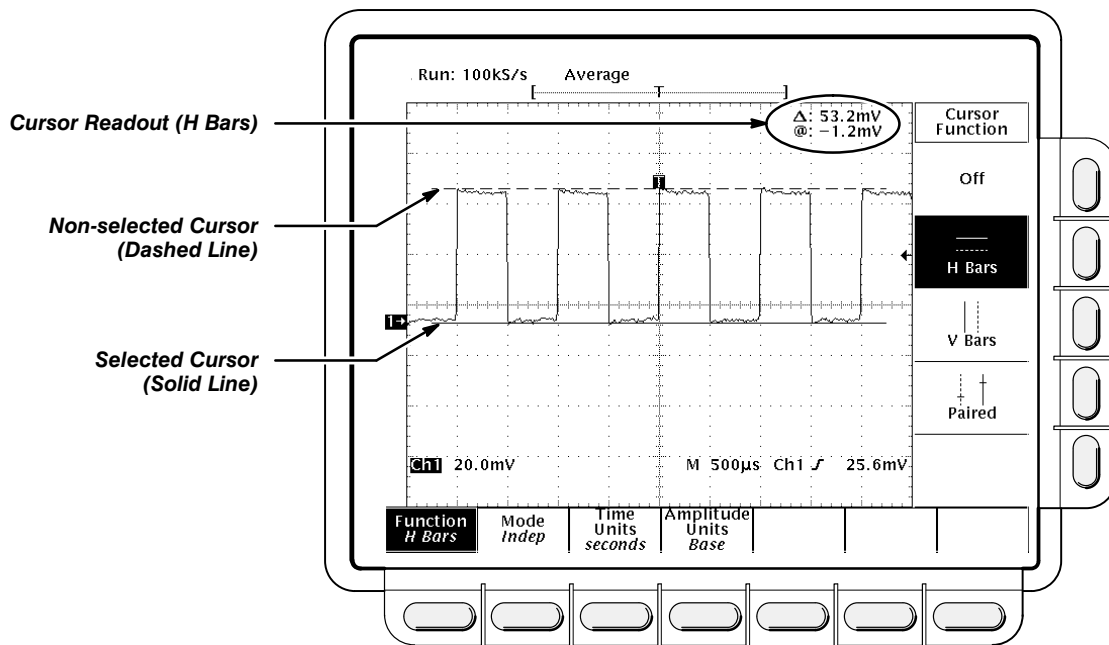

Figure 3-10: H Bars Cursor Menu and Readouts

Paired cursors can only show voltage differences when they remain on screen. If the paired cursors are moved off screen horizontally, **Edge** will replace the voltage values in the cursor readout.

Operation

To take cursor measurements, press **CURSOR** to display the Cursor menu (Figure 3-10).

Function

Select the type of cursors you want using the **Function** menu item:

Press **CURSOR** → **Function** (main) → **H Bars**, **V Bars**, **Paired**, or **Off** (side).

Cursor Measurements

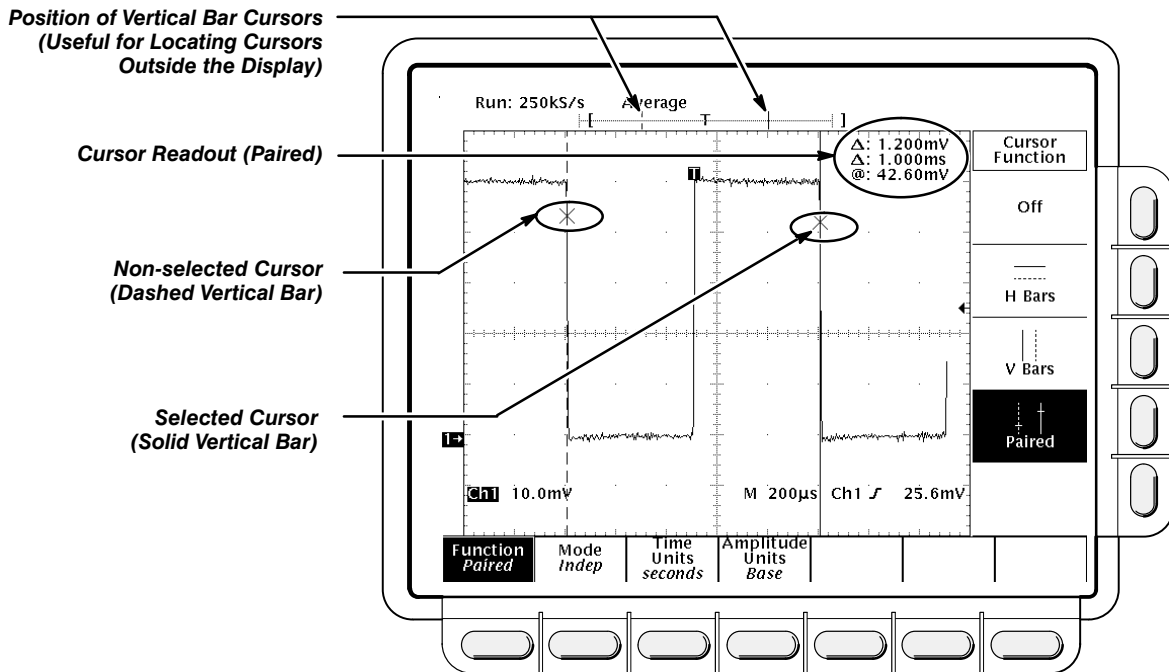

Figure 3-11: Paired Cursor Menu and Readouts

Mode

Select the cursor mode you want using the **Mode** menu item.

1. Press **CURSOR** → **Mode** (main) → **Independent** or **Tracking** (side):
 - **Independent** makes each cursor positionable without regard to the position of the other cursor.
 - **Tracking** makes both cursors positionable in tandem; that is, both cursors move in unison and maintain a fixed horizontal or vertical distance between each other.
2. Use the general purpose knob to move the selected (active) cursor if **Independent** was selected in step 1. Press **SELECT** to change which cursor is active and moves. A solid line indicates the active cursor, and a dashed line the inactive cursor.

or

Use the general purpose knob to move both cursors in tandem if **Tracking** was selected in step 1. Press **SELECT** to temporarily suspend cursor tracking; then use the general purpose knob to adjust the distance of the solid cursor relative to the dashed cursor. Press **SELECT** again to resume tracking. A solid line indicates the adjustable cursor and a dashed line the fixed cursor.

Time Units

You can choose to display vertical bar cursor results in units of time or frequency. If you have Option 5 Video, you can also display the results in terms of video line number.

Press **CURSOR** → **Time Units** (main) → **seconds** or **1/seconds (Hz)** or, with Option 5, **video line number** (side).

Amplitude Units

If you are measuring NTSC signals, you can choose to display vertical readings in IRE units. If you are trying to do this, you should have option 05 Video Trigger installed as it would be difficult to trigger on composite video waveforms without option 05.

Press **CURSOR** → **Amplitude Units** (main) → **IRE (NTSC)**

To return to normal:

Press **CURSOR** → **Amplitude Units** (main) → **Base**

Cursor Speed

You can change the cursors speed by pressing **SHIFT** before turning the general purpose knob. The cursor moves faster when the **SHIFT** button is lighted and the display reads **Coarse Knobs** in the upper right corner.

For More Information

See *Measurements*, on page 2-26.

See *Waveform Math*, on page 3-148, for information on cursor units with multiplied waveforms.

See *Fast Fourier Transforms* on page 3-36, *Waveform Differentiation* on page 3-139, and *Waveform Integration* on page 3-143, if your oscilloscope is equipped with Option 2F Advanced DSP Math (standard on the TDS 644A), for information on cursor units with integrated, differentiated, and FFT waveforms.

See the *TDS Family Option 05 Video Trigger Interface*, if your oscilloscope is equipped with the video trigger option, for information on cursor units with video waveforms.

Delayed Triggering

The TDS 600A Series oscilloscopes provide a main time base and a delayed time base. The delayed time base, like the main time base, requires a trigger signal and an input source dedicated to that signal. You can only use delay with respect to the main edge trigger and certain classes of main pulse triggers.

There are two different ways to delay the acquisition of waveforms: *delayed runs after main* and *delayed triggerable*. Only delayed triggerable uses the delayed trigger system.

Delayed runs after main looks for a main trigger, then waits a user-defined time, and then starts acquiring (see Figure 3-12).

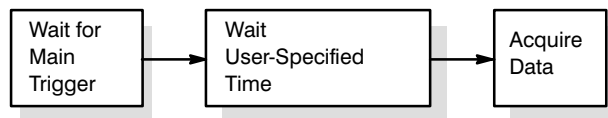

Figure 3-12: Delayed Runs After Main

Delayed triggerable looks for a main trigger and then, depending on the type of delayed trigger selected, makes one of the three types of delayed triggerable mode acquisitions listed below (see Figure 3-13).

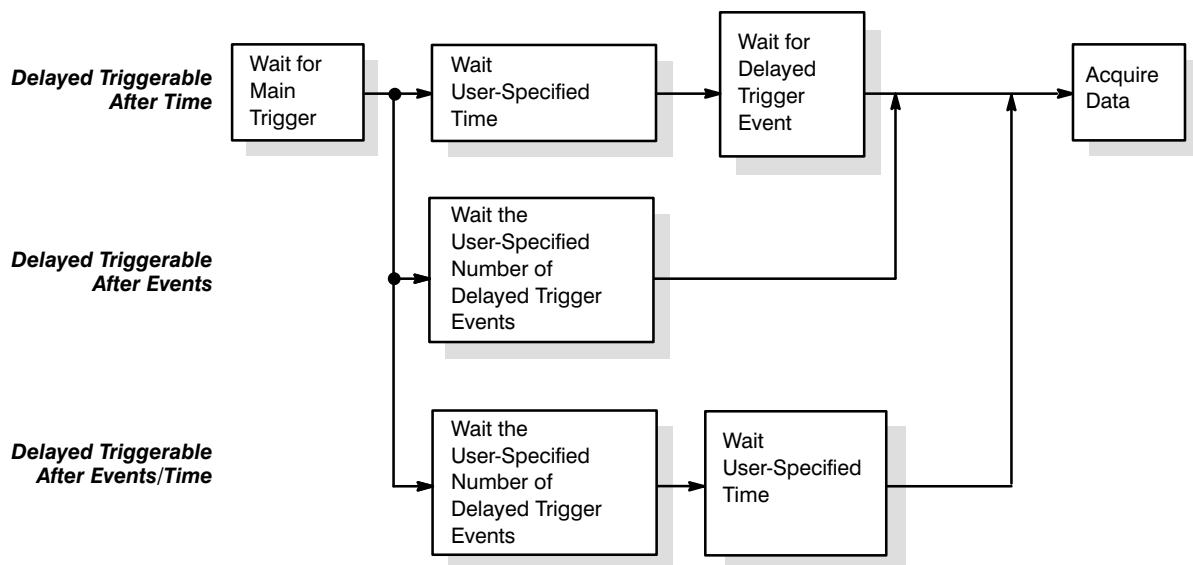

Figure 3-13: Delayed Triggerable

- *After Time* waits the user-specified time, then waits for the next delayed trigger event, and then acquires.
- *After Events* waits for the specified number of delayed trigger events and then acquires.
- *After Events/Time* waits for the specified number of delayed trigger events, then waits the user-specified time, and then acquires.

The digitizing oscilloscope is always acquiring samples to fill the pretrigger part of the waveform record. When and if delay criteria are met, it takes enough posttrigger samples to complete the delayed waveform record and then displays it. Refer to Figure 3-14 for a more detailed look at how delayed records are placed in time relative to the main trigger.

NOTE

When using the delayed triggerable mode, the digitizing oscilloscope provides a conventional edge trigger for the delayed time base. The delayed time base will not trigger if the main trigger type (as defined in the Main Trigger menu) is logic, if the main trigger type is edge with its source set to auxiliary, or if the main trigger type is pulse with the runt trigger class selected.

Operation

You use the Horizontal menu to select and define either delayed runs after main or delayed triggerable. Delayed triggerable, however, requires further selections in the Delayed Trigger menu.

Delayed Runs After Main

1. Press **HORIZONTAL MENU** → **Time Base** (main) → **Delayed Only** (side) → **Delayed Runs After Main** (side). Use the general purpose knob or the keypad to set the delay time.

If you press **Intensified** (side), you display an intensified zone on the main timebase record that shows where the delayed timebase record occurs relative to the main trigger. For Delayed Runs After Main mode, the start of the intensified zone corresponds to the start of the delayed timebase record. The end of the zone corresponds to the end of the delayed record.

Delayed Triggering



Delayed Runs After Main

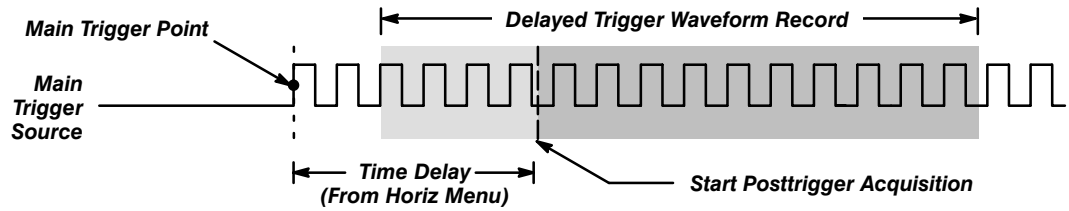

Delayed Triggerable By Events

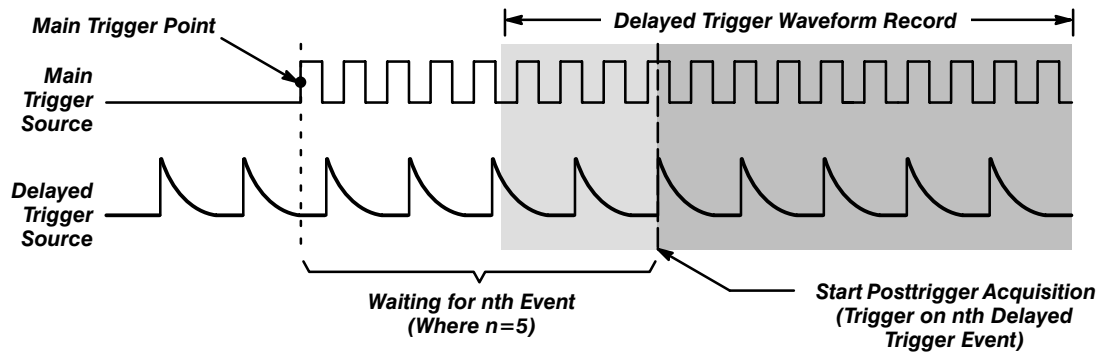

Delayed Triggerable By Time

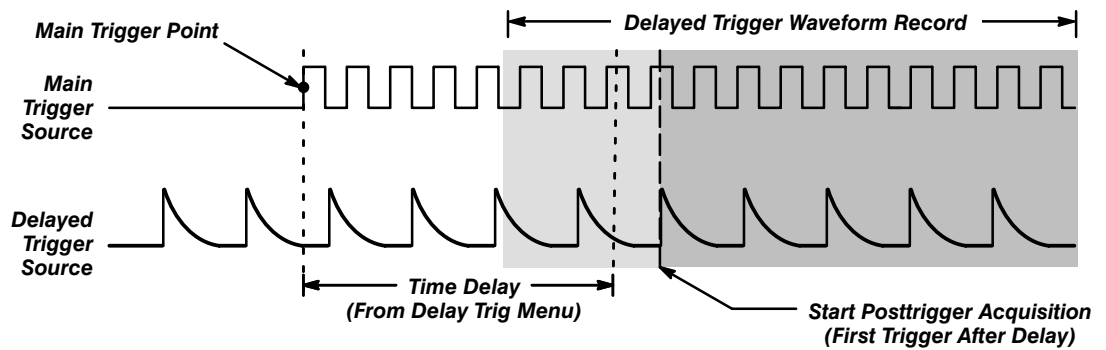

Delayed Triggerable By Events/Time

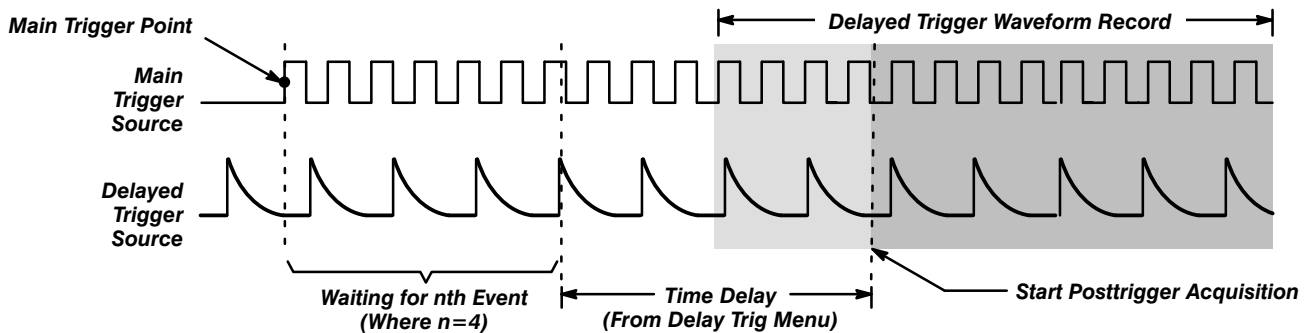

Figure 3-14: How the Delayed Triggers Work

Delayed Triggerable

You must make sure that the Main Trigger menu settings are compatible with Delayed Triggerable.

1. Press **TRIGGER MENU**.
2. If **Type** is set to **Logic**, press **Type** (main) to change it to either **Edge** or **Pulse** as fits your application. Logic type is incompatible with Delayed Triggerable.
3. If **Source** is set to **Auxiliary**, press **Source** (main). Select any source other than Auxiliary from the side menu according to your application.
4. Press **HORIZONTAL MENU** → **Time Base** (main) → **Delayed Only** (side) → **Delayed Triggerable** (side).

NOTE

The Delayed Triggerable menu item is not selectable unless incompatible Main Trigger menu settings are eliminated. (See the steps at the beginning of this procedure.) If such is the case, the Delayed Triggerable menu item is dimmer than other items in the menu.

By pressing **Intensified** (side), you can display an intensified zone that shows where the delayed timebase record *may* occur (a valid delay trigger event must be received) relative to the main trigger on the main time base. For Delayed Triggerable After mode, the start of the intensified zone corresponds to the possible start point of the delayed time base record. The end of the zone continues to the end of main time base, since a delayed time base record may be triggered at any point after the delay time elapses.

To learn how to define the intensity level of the normal and intensified waveform, see *Display Modes* on page 3-26.

Now you need to bring up the Delayed Trigger menu so you can define the delayed trigger event.

5. Press **SHIFT DELAYED TRIG** → **Delay by** (main) → **Triggerable After Time, Events, or Events/Time** (side) (Figure 3-15).
6. Enter the delay time or events using the general purpose knob or the keypad. If you selected **Events/Time**, use **Time** (side) and **Events** (side) to switch between setting the time and the number of events.

Hint: You can go directly to the Delayed Trigger menu (see step 5). By selecting one of Triggerable After Time, Events, or Events/Time, the oscilloscope automatically switches to Delayed Triggerable in the Horizontal menu. You will still need to display the Horizontal menu if you wish to leave Delayed Triggerable.

The **Source** menu lets you select which input will be the delayed trigger source.

7. Press **Source** (main) → **Ch1, Ch2, Ch3 (Ax1 on the TDS 620A), Ch4 (Ax2 on the TDS 620A), or Auxiliary** (side).

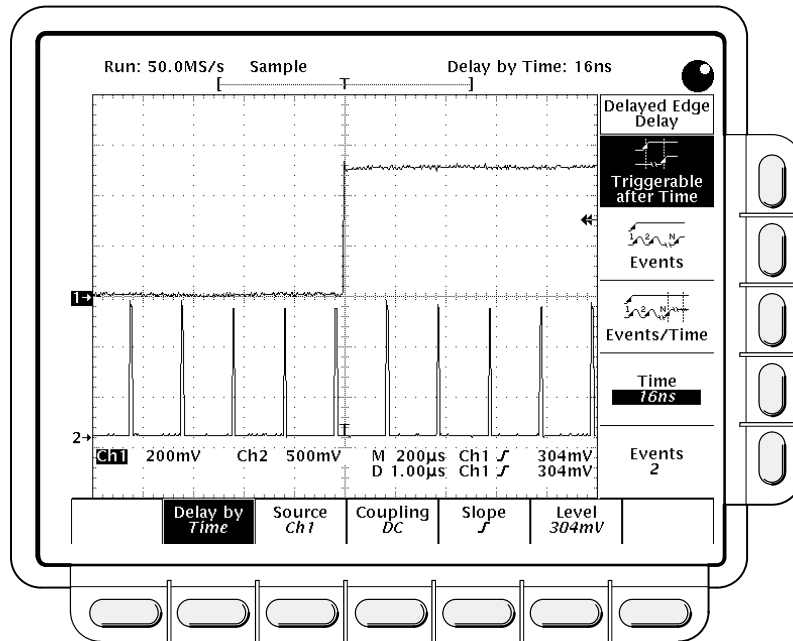

Figure 3-15: Delayed Trigger Menu

8. Press **Coupling** (main) → **DC, AC, HF Rej, LF Rej, or Noise Rej** (side) to define how the input signal will be coupled to the delayed trigger. For descriptions of these coupling types, see *Triggering* on page 2-13.
9. Press **Slope** (main) to select the slope that the delayed trigger will occur on. Choose between the rising edge and falling edge slopes.

When using Delayed Triggerable mode to acquire waveforms, two trigger bars are displayed. One trigger bar indicates the level set by the main trigger system; the other indicates the level set by the delayed trigger system.

10. Press **Level** (main) → **Level, Set to TTL, Set to ECL, or Set to 50%** (side).
 - **Level** lets you enter the delayed trigger level using the general purpose knob or the keypad.
 - **Set to TTL** fixes the trigger level at +1.4 V.
 - **Set to ECL** fixes the trigger level at -1.3 V.

NOTE

When you set the Vertical **SCALE** smaller than 200 mV, the oscilloscope reduces the **Set to TTL** or **Set to ECL** trigger levels below standard TTL and ECL levels. That happens because the trigger level range is fixed at ± 12 divisions from the center. At 100 mV (the next smaller setting after 200 mV) the trigger range is ± 1.2 V which is smaller than the typical TTL (+1.4 V) or ECL (–1.3 V) level.

- **Set to 50%** fixes the delayed trigger level to 50% of the peak-to-peak value of the delayed trigger source signal.

**For More
Information**

See *Triggering*, on page 2-13.

See *Triggering*, on page 3-132.

Display Modes

The digitizing oscilloscope can display waveform records in different ways. The Display menu lets you adjust the oscilloscope display style, intensity level, graticule, and format.

Operation

To bring up the Display menu:

1. Press **DISPLAY** to show the Display menu.
2. On the TDS 644A, press **Setting** in the main menu until you select **Display** from the pop-up menu.

Display lets you adjust the style, intensity level, graticule, and format features described below. **Color** (TDS 644A) lets you alter color settings for various display components such as waveforms and text. For more information on color, see *Color* on page 3-10.

Display Style

Press **DISPLAY** → **Style** (main) → **Vectors**, **Intensified Samples**, **Dots**, **Infinite Persistence**, or **Variable Persistence** (side) (Figure 3-16).

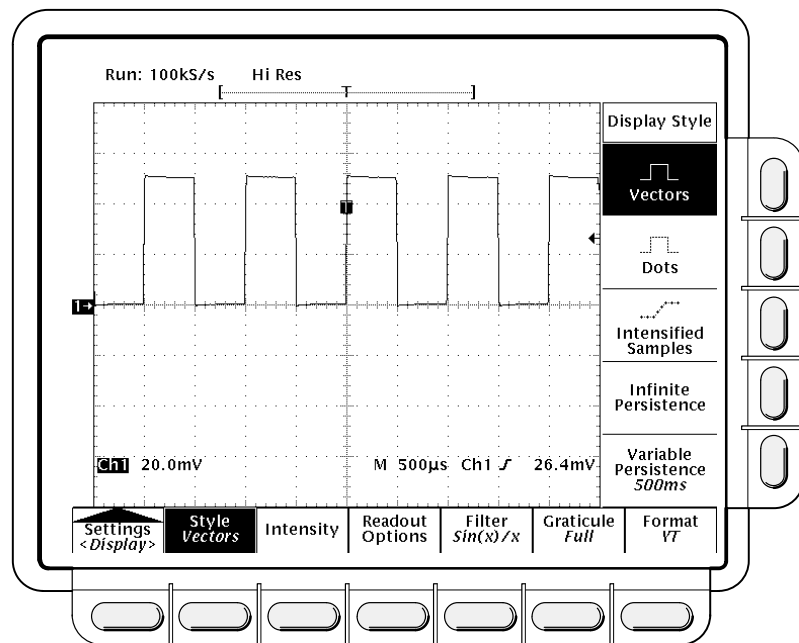

Figure 3-16: Display Menu — Style

- **Vectors** has the display draw vectors (lines) between the record points.
- **Dots** display waveform record points as dots.
- **Intensified Samples** also displays waveform record points as dots. However, the points actually sampled are displayed in the **Zone** color (TDS 644A) or intensified relative to the interpolated points.

In addition to choosing Intensified Samples in the side menu, the oscilloscope must be interpolating or Zoom must be on with its horizontal expansion greater than 1X. See interpolation on page 2-20; see Zoom beginning on page 3-151.

- **Variable Persistence** lets the record points accumulate on screen over many acquisitions and remain displayed only for a specific time interval. In that mode, the display behaves like that of an analog oscilloscope. You enter the time for that option with the keypad or the general purpose knob. On color instruments, record points are also displayed with colors that vary depending on the points persistence. See Choose Palette on page 3-11.
- **Infinite Persistence** lets the record points accumulate until you change some control (such as scale factor) causing the display to be erased.

Intensity

Intensity lets you set text/graticule and waveform intensity (brightness) levels. To set the intensity:

Press **DISPLAY** → **Intensity** (main) → **Overall** (TDS 640A & TDS 620A), **Text/Grat**, **Waveform**, or **Contrast** (TDS 640A & TDS 620A) (side). Enter the intensity percentage values with the keypad or the general purpose knob.

All intensity adjustments operate over a range from 20% (close to fully off) to 100% (fully bright).

Contrast (TDS 640A & TDS 620A) operates over a range from 100% (no contrast) to 250% (intensified portion at full brightness).

NOTE

*The Intensified setting for Timebase in the horizontal menu causes a zone on the waveform to be displayed in the **Zone** color (TDS 644A) or intensified relative to the rest of the waveform. If the contrast is set to 100%, you won't be able to distinguish the intensified portion from the rest of the waveform because both are the same brightness.*

Display Readout

Readout options control whether the trigger indicator, trigger level bar, and current date and time appear on the display. The options also control what style trigger level bar, long or short, is displayed.

1. Press **DISPLAY** → **Readout** (main).
2. Toggle **Display 'T' @ Trigger Point** (side) to select whether or not to display 'T' indicating the trigger point. You can select **ON** or **OFF**. (The trigger point indicates the position of the trigger in the waveform record.)
3. Press **Trigger Bar Style** (side) to select either the short or the long trigger bar or to turn the trigger bar off. (See Figure 3-17. Note that both styles are shown for illustrating purposes, but you can only display one style at a time.)

The trigger bar is only displayed if the trigger source is an active, displayed waveform. Also, two trigger bars are displayed when delay triggerable acquisitions are displayed — one for the main and one for the delayed timebase. The trigger bar is a visual indicator of the trigger level.

Sometimes, especially when using the hardcopy feature, you may wish to display the current date and time on screen. For more information about displaying and setting date and time, see *Date/Time Stamping Your Hardcopy* on page 3-60.)

4. Press **Display Date/Time** (side) to turn it on or off. Push **Clear Menu** to see the current date and time.

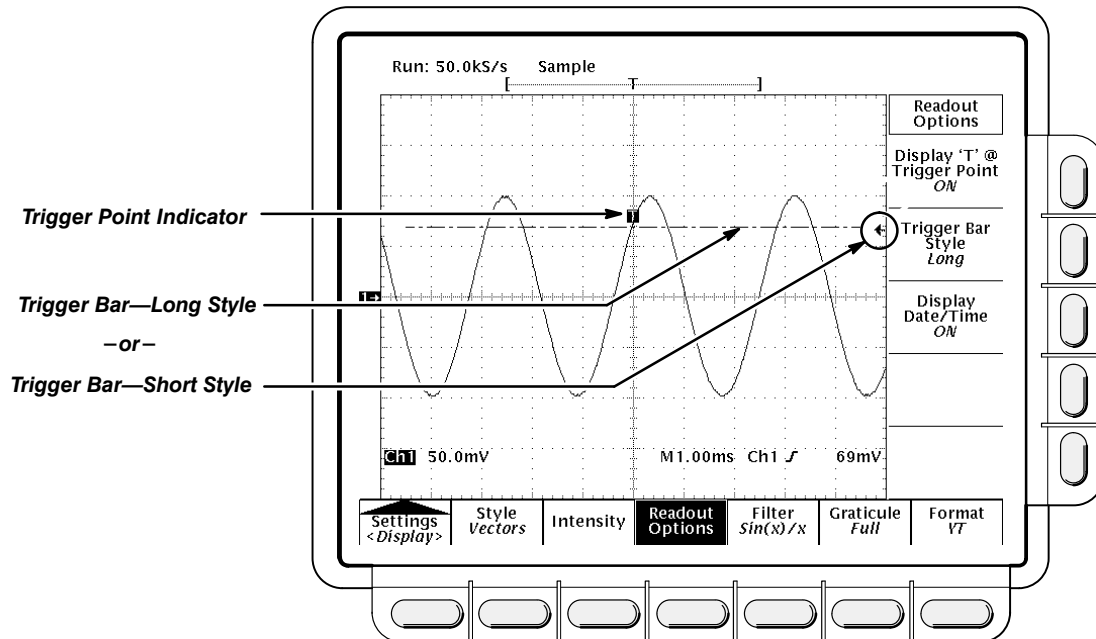

Figure 3-17: Trigger Point and Level Indicators

Filter Type

The display filter types are $\sin(x)/x$ interpolation and linear interpolation. For more information see the *Concepts* section, page 2-20.

Press **DISPLAY** → **Filter** (main) → **Sin(x)/x Interpolation** or **Linear Interpolation** (side).

NOTE

When the horizontal scale is set to rates faster than 25 ns/div, or when using the ZOOM feature to expand waveforms horizontally, interpolation occurs. (The filter type, linear or $\sin(x)/x$, depends on which is set in the Display menu.) Otherwise, interpolation is not needed. See Sampling and Digitizing on page 2-19 for a discussion of sampling including interpolation.

Graticule Type

To change the graticule:

Press **DISPLAY** → **Graticule** (main) → **Full, Grid, Cross Hair, Frame, NTSC** or **PAL** (side).

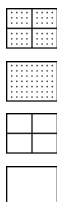

- **Full** provides a grid, cross hairs and a frame.
- **Grid** displays a frame and a grid.
- **Cross Hair** provides cross hairs, and a frame.
- **Frame** displays just a frame.
- **NTSC** provides a grid useful for measuring NTSC-class waveforms.
- **PAL** provides a grid useful for measuring PAL-class waveforms.

NOTE

Selecting either NTSC or PAL graticules automatically changes the vertical scale, position settings, coupling, and sets to zero any vertical offset of any channel displayed. These settings are not restored after switching to other graticule types. Therefore, you might wish to recall the factory setup or other stored setup after selecting a different graticule.

Format

There are two kinds of format: YT and XY.



YT is the conventional oscilloscope display format. It shows a signal voltage (the vertical axis) as it varies over time (the horizontal axis).



XY format compares the voltage levels of two waveform records point by point. That is, the digitizing oscilloscope displays a graph of the voltage of one waveform record against the voltage of another waveform record. This mode is particularly useful for studying phase relationships.

To set the display axis format:

Press **DISPLAY** → **Format** (main) → **XY** or **YT** (side).

When you choose the XY mode, the input you have selected is assigned to the X-axis, and the digitizing oscilloscope automatically chooses the Y-axis input (see Table 3-2).

Table 3-2: XY Format Pairs

X-Axis Channel (User Selectable)	Y-Axis Channel (Fixed)
Ch 1	Ch 2
Ch 3 (TDS 644A & TDS 640A) (Aux 1 on the TDS 620A)	Ch 4 (TDS 644A & TDS 640A) (Aux 2 on the TDS 620A)
Ref 1	Ref 2
Ref 3	Ref 4

For example, if you press the **CH 1** button, the digitizing oscilloscope will display a graph of the channel 1 voltage levels on the X-axis against the channel 2 voltage levels on the Y-axis. That will occur whether or not you are displaying the channel 2 waveform in YT format. If you later press the **WAVEFORM OFF** button for either channel 1 or 2, the digitizing oscilloscope will delete the XY graph of channel 1 versus channel 2.

Since selecting **YT** or **XY** affects only the display, the horizontal and vertical scale and position knobs and menus control the same parameters regardless of the mode selected. Specifically, in XY mode, the horizontal scale will continue to control the time base and the horizontal position will continue to control which portion of the waveforms are displayed.

XY format is a dot-only display, although it can have persistence. The **Vector** style selection has no effect when you select XY format.

You cannot display Math waveforms in XY format. They will disappear from the display when you select XY.

NOTE

Use at higher room temperatures or with higher intensity display formats, such as the white fields in the Hardcopy palette, can temporarily degrade display quality.

**For More
Information**

See *Acquisition*, on page 2-19.

See *Color*, on page 3-10.

See *Measurements*, on page 2-26.

Edge Triggering

An *edge trigger* event occurs when the trigger source passes through a specified voltage level in a specified direction (the trigger slope). You will likely use edge triggering for most of your measurements.

You can select the edge source, coupling, slope, level, and mode (auto or normal).

Edge Trigger Readouts

The Trigger readout shows some key trigger parameters (Figure 3-18).

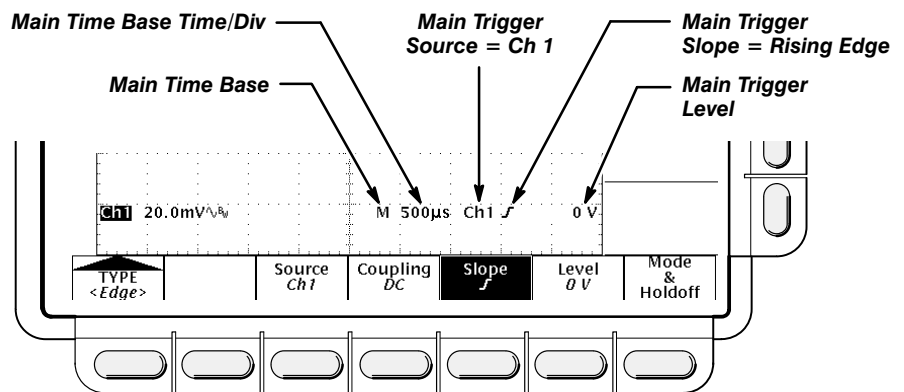

Figure 3-18: Edge Trigger Readouts

Operation

The Edge Trigger menu lets you select the source, coupling, slope, trigger level, mode, and holdoff.

To bring up the Edge Trigger menu:

Press **TRIGGER MENU** → **Type** (main) → **Edge** (pop-up) (see Figure 3-19).

Source

To select which source you want for the trigger:

Press **TRIGGER MENU** → **Type** (main) → **Edge** (pop-up) → **Source** (main) → **Ch1**, **Ch2**, **Ch3** (Ax1 on the TDS 620A), **Ch4** (Ax2 on the TDS 620A), **AC Line**, or **Auxiliary** (side).

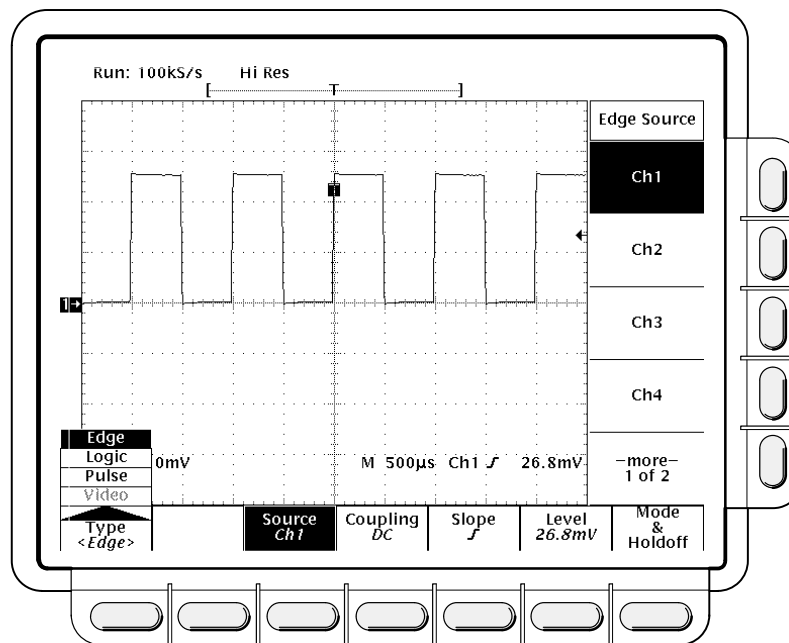

Figure 3-19: Main Trigger Menu — Edge Type

Coupling

To select the coupling you want:

Press **TRIGGER MENU** → **Type** (main) → **Edge** (pop-up) → **Coupling** (main) → **DC**, **AC**, **HF Rej**, **LF Rej**, or **Noise Rej** (side).

DC

AC 





- **DC** passes all of the input signal. In other words, it passes both AC and DC components to the trigger circuit.
- **AC** passes only the alternating components of an input signal (above 10 Hz). It removes the DC component from the trigger signal.
- **HF Rej** removes the high frequency portion of the triggering signal. That allows only the low frequency components to pass on to the triggering system to start an acquisition. High frequency rejection attenuates signals above 30 kHz.
- **LF Rej** does the opposite of high frequency rejection. Low frequency rejection attenuates signals below 80 kHz.
- **Noise Rej** provides lower sensitivity. **Noise Rej** requires additional signal amplitude for stable triggering, reducing the chance of falsely triggering on noise.

Slope

To select the slope that the edge trigger will occur on:

1. Press the **TRIGGER MENU** → **Type** (main) → **Edge** (pop-up) → **Slope** (main).
2. Alternatives for slope are the rising and falling edges.



Level

Press the **TRIGGER MENU** → **Type** (main) → **Edge** (pop-up) → **Level** (main) → **Level**, **Set to TTL**, **Set to ECL**, or **Set to 50%** (side).

- **Level** lets you enter the trigger level using the general purpose knob or the keypad.
- **Set to TTL** fixes the trigger level at +1.4 V.
- **Set to ECL** fixes the trigger level at -1.3 V.

NOTE

*When you set the volts/div smaller than 200 mV, the oscilloscope reduces the **Set to TTL** or **Set to ECL** trigger levels below standard TTL and ECL levels. That happens because the trigger level range is fixed at ± 12 divisions from the center. At 100 mV (the next smaller setting after 200 mV) the trigger range is ± 1.2 V, which is smaller than the typical TTL (+1.4 V) or ECL (-1.3 V) level.*

- **Set to 50%** fixes the trigger level to approximately 50% of the peak-to-peak value of the trigger source signal.

Mode & Holdoff

You can change the holdoff time and select the trigger mode using this menu item. See Triggering on page 2-13 for more details.

1. Press the **TRIGGER MENU** → **Mode & Holdoff** (main) → **Auto** or **Normal** (side).
 - In **Auto** mode the oscilloscope acquires a waveform after a specific time has elapsed even if a trigger does not occur. The amount of time the oscilloscope waits depends on the time base setting.
 - In **Normal** mode the oscilloscope acquires a waveform only if there is a valid trigger.
2. To change the holdoff time, press **Holdoff** (side). Enter the value in % using the general purpose knob or the keypad.

If you want to enter a large number using the general purpose knob, press the **SHIFT** button before turning the knob. When the light above the **SHIFT** button is on and the display says **Coarse Knobs** in the upper right corner, the general purpose knob speeds up significantly.

You can set holdoff from 0% (minimum holdoff available) to 100% (maximum available). See *Holdoff, Variable, Main Trigger* in the TDS 620A, 640A, & 644A *Performance Verification Manual*, Section 2 on *Specifications, Typical Characteristics* for typical minimum and maximum values.

Holdoff is automatically reset to 0% when you change the main time base time/division setting. However, it is not reset if you change the delayed time base time/division (that is, when the time base setting in the Horizontal menu is **Intensified** or **Delayed Only**).

For More Information

See *Triggering*, on page 2-13.

See *Triggering*, on page 3-132.

Fast Fourier Transforms

Advanced DSP Math (optional on TDS 620A & TDS 640A), provides the Fast Fourier Transform (FFT). The FFT allows you to transform a waveform from a display of its amplitude against time to one that plots the amplitudes of the various discrete frequencies the waveform contains. Further, you can also display the phase shifts of those frequencies. Use FFT math waveforms in the following applications:

- Testing impulse response of filters and systems
- Measuring harmonic content and distortion in systems
- Characterizing the frequency content of DC power supplies
- Analyzing vibration
- Analyzing harmonics in 50 and 60 cycle lines
- Identifying noise sources in digital logic circuits

Description

The FFT computes and displays the frequency content of a waveform you acquire as an FFT math waveform. This *frequency domain* waveform is based on the following equation:

$$X(k) = \frac{1}{N} \sum_{n = \frac{-N}{2}}^{\frac{N}{2} - 1} x(n)e^{-\frac{j2\pi nk}{N}} \quad \text{for } k = 0 \text{ to } N - 1$$

Where:

- $x(n)$ is a point in the time domain record data array
- $X(k)$ is a point in the frequency domain record data array
- n is the index to the time domain data array
- k is the index to the frequency domain data array
- N is the FFT length
- j is the square root of -1

The resulting waveform is a display of the magnitude or phase angle of the various frequencies the waveform contains with respect to those frequencies. For example, Figure 3-20 shows the non-transformed impulse response of a system in channel 2 at the top of the screen. The FFT-transformed magnitude and phase appear in the two math waveforms below the

impulse. The horizontal scale for FFT math waveforms is always expressed in frequency per division with the beginning (left-most point) of the waveform representing zero frequency (DC).

The FFT waveform is based on digital signal processing (DSP) of data, which allows more versatility in measuring the frequency content of waveforms. For example, DSP allows the oscilloscope to compute FFTs of source waveforms that must be acquired based on a single trigger, making it useful for measuring the frequency content of single events.

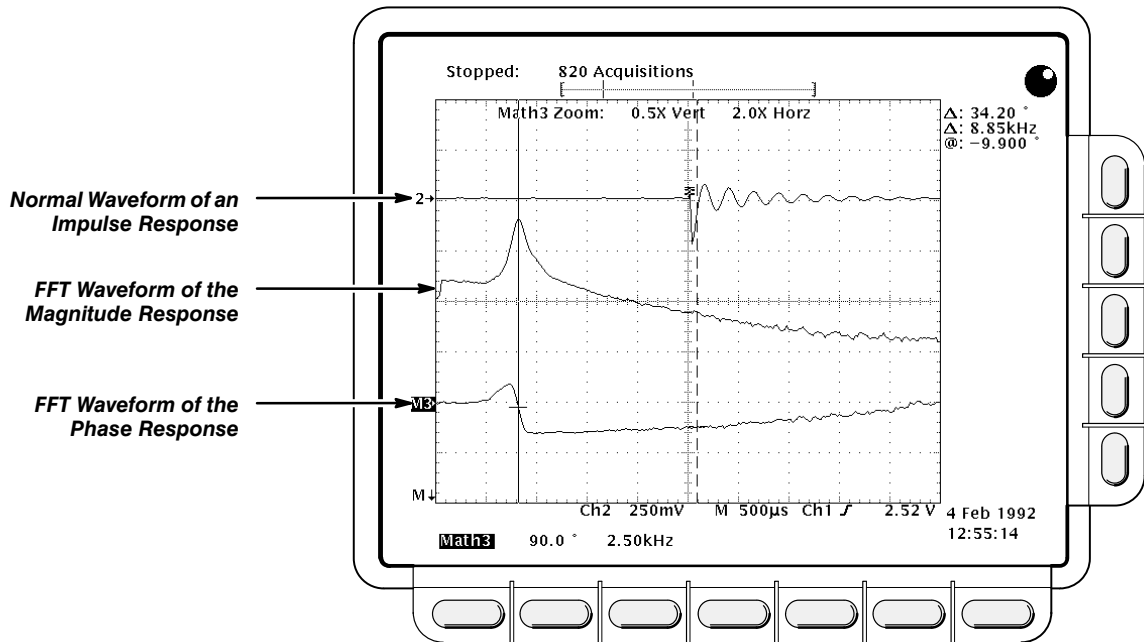

Figure 3-20: System Response to an Impulse

Operation

To obtain an FFT of your waveform:

1. Connect the waveform to the desired channel input and select that channel.
2. Adjust the vertical and horizontal scales and trigger the display (or press **AUTOSET**).

The topic *Offset, Position, and Scale*, on page 3-44, provides in depth information about optimizing your setup for FFT displays.

3. Press **MORE** to access the menu for turning on math waveforms.
4. Select a math waveform. Your choices are **Math1**, **Math2**, and **Math3** (main).

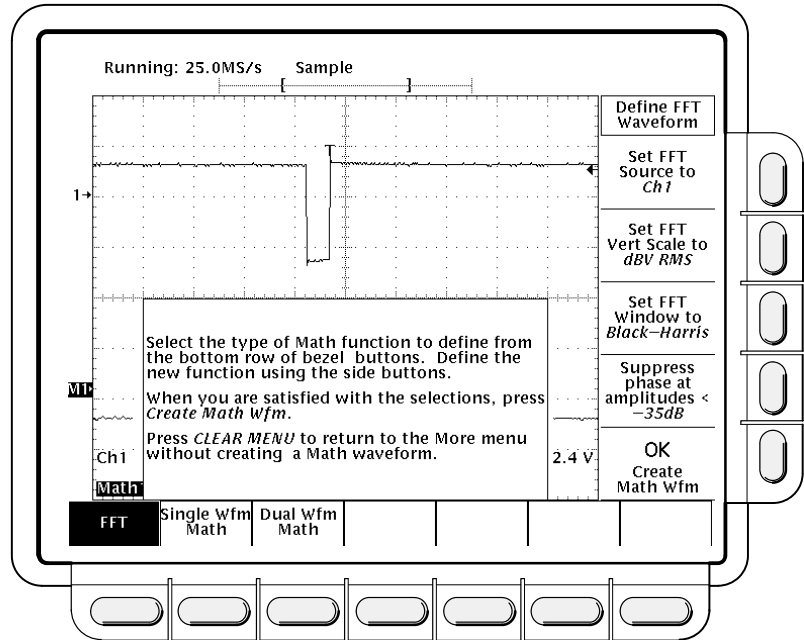

Figure 3-21: Define FFT Waveform Menu

5. If the selected math waveform is not FFT, press **Change Math Definition** (side) → **FFT** (main). See Figure 3-21.
6. Press **Set FFT Source to** (side) repeatedly until the channel source selected in step 1 appears in the menu label.
7. Press **Set FFT Vert Scale to** (side) repeatedly to choose from the following vertical scale types:
 - **dBV RMS** — Magnitude is displayed using log scale, expressed in dB relative to $1 V_{RMS}$ where $0 \text{ dB} = 1 V_{RMS}$.
 - **Linear RMS** — Magnitude is displayed using voltage as the scale.
 - **Phase (deg)** — Phase is displayed using degrees as the scale, where degrees wrap from -180° to $+180^\circ$.
 - **Phase (rad)** — Phase is displayed using radians as the scale, where radians wrap from $-\pi$ to $+\pi$.

The topic *Considerations for Phase Displays*, on page 3-47, provides in depth information on setup for phase displays.

8. Press **Set FFT Window to** (side) repeatedly to choose from the following window types:
 - **Rectangular** — Best type for resolving frequencies that are very close to the same value but worst for accurately measuring the amplitude of those frequencies. Best type for measuring the frequency spectrum of non-repetitive signals and measuring frequency components near DC.

- **Hamming** — Very good window for resolving frequencies that are very close to the same value with somewhat improved amplitude accuracy over the rectangular window.
- **Hanning** — Very good window for measuring amplitude accuracy but degraded for resolving frequencies.
- **Blackman-Harris** — Best window for measuring the amplitude of frequencies but worst at resolving frequencies.

The topic *Selecting the Window*, on page 3-49, provides in depth information on choosing the right window for your application.

9. If you did not select **Phase (deg)** or **Phase (rad)** in step 7, skip to step 12. Phase suppression is only used to reduce noise in phase FFTs.
10. If you need to reduce the effect of noise in your phase FFT, press **Suppress phase at amplitudes <** (side).
11. Use the general purpose knob (or the keypad if your oscilloscope is so equipped) to adjust the phase suppression level. FFT magnitudes below this level will have their phase set to zero.

The topic *Adjust Phase Suppression*, on page 3-48, provides additional information on phase suppression.

12. Press **OK Create Math Wfm** (side) to display the FFT of the waveform you input in step 1 (see Figure 3-22).

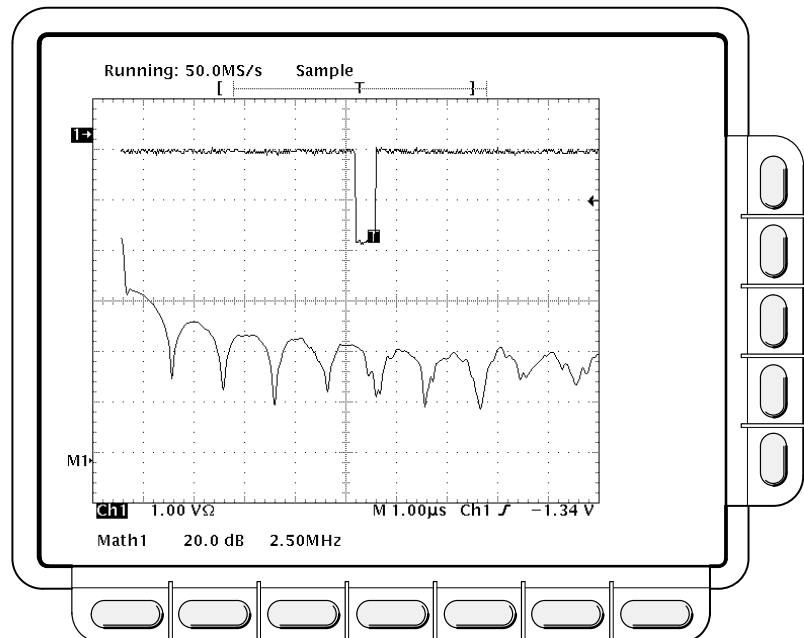

Figure 3-22: FFT Math Waveform in Math1

Cursor Measurements of an FFT

Once you have displayed an FFT math waveform, use cursors to measure its frequency amplitude or phase angle.

1. Be sure **MORE** is selected in the channel selection buttons and that the FFT math waveform is selected in the **More** main menu.
2. Press **CURSOR** → **Mode** (main) → **Independent** (side) → **Function** (main) → **H Bars** (side).
3. Use the general purpose knob to align the selected cursor (solid line) to the top (or to any amplitude on the waveform you choose).
4. Press **SELECT** to select the other cursor. Use the general purpose knob to align the selected cursor to the bottom (or to any amplitude on the waveform you choose).
5. Read the amplitude between the two cursors from the **Δ**: readout. Read the amplitude of the selected cursor relative to either $1 V_{RMS}$ (0 dB), ground (0 volts), or the zero phase level (0 degrees or 0 radians) from the **@**: readout. (The waveform reference indicator at the left side of the graticule indicates the level where phase is zero for phase FFTs.)

Figure 3-23 shows the cursor measurement of a frequency magnitude on an FFT. The **@**: readout reads 0 dB because it is aligned with the $1 V_{RMS}$ level. The **Δ**: readout reads 24.4 dB indicating the magnitude of the frequency it is measuring is -24.4 dB relative to $1 V_{RMS}$. The source waveform is turned off in the display.

The cursor units will be in dB or volts for FFTs measuring magnitude and in degrees or radians for those FFTs measuring phase. The cursor unit depends on the selection made for **Set FFT Vert Scale to** (side). See step 7 on page 3-38 for more information.

6. Press **V Bars** (side). Use the general purpose knob to align one of the two vertical cursors to a point of interest along the horizontal axis of the waveform.
7. Press **SELECT** to select the alternate cursor.
8. Align the selected cursor to another point of interest on the math waveform.
9. Read the frequency difference between the cursors from the **Δ**: readout. Read the frequency of the selected cursor relative to the zero frequency point from the **@**: readout.

The cursor units will always be in Hz, regardless of the setting in the **Time Units** side menu. The first point of the FFT record is the zero frequency point for the **@**: readout.

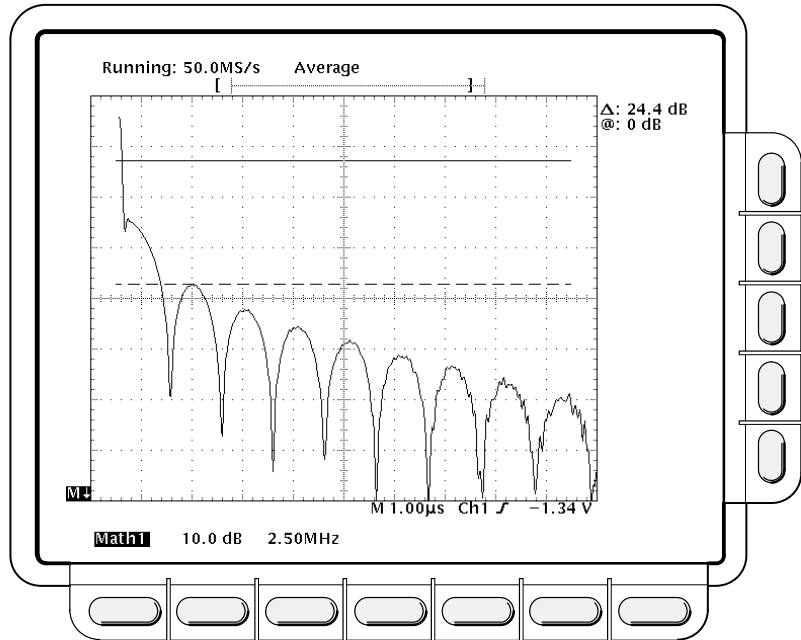

Figure 3-23: Cursor Measurement of an FFT Waveform

10. Press **Function** (main) → **Paired** (side).
11. Use the technique just outlined to place the vertical bar of each paired cursor to the points along the horizontal axis you are interested in.
12. Read the amplitude between the X of the two paired cursors from the top-most **Δ:** readout. Read the amplitude of the short horizontal bar of the selected (solid) cursor relative to either 1 V_{RMS} (0 dB), ground (0 volts), or zero phase level (0 degrees or 0 radians) from the **@:** readout. Read the frequency between the long horizontal bars of both paired cursors from the bottom **Δ:** readout.

Automated Measurements of an FFT

You can also use automated measurements to measure FFT math waveforms. Use the same procedure as is found under *Waveform Differentiation* on page 3-140.

Considerations for Using FFTs

There are several characteristics of FFTs that affect how they are displayed and should be interpreted. Read the following topics to learn how to optimize the oscilloscope setup for good display of your FFT waveforms.

The FFT Frequency Domain Record

The following topics discuss the relation of the source waveform to the record length, frequency resolution, and frequency range of the FFT frequency domain record. (The FFT frequency domain waveform is the FFT math waveform that you display.)

FFTs May Not Use All of the Waveform Record — The *FFT math waveform* is a display of the magnitude or phase data from the *FFT frequency domain record*. This frequency domain record is derived from the FFT time domain record, which is derived from the *waveform record*. All three records are described below.

Waveform Record — the complete waveform record acquired from an input channel and displayed from the same channel or a reference memory. The length of this *time domain* record is user-specified from the Horizontal menu. The waveform record is not a DSP Math waveform.

FFT Time Domain Record — that part of the waveform record that is input to the FFT. This time domain record waveform becomes the FFT math waveform after it is transformed. Its record length depends on the length of the waveform record defined above.

FFT Frequency Domain Record — the FFT math waveform after digital signal processing converts data from the FFT time domain record into a frequency domain record.

Figure 3-24 compares the waveform record to the FFT time domain record. Note the following relationships:

- For waveform records ≤ 10 K points in length, the FFT uses all of the waveform record as input.
- For waveform records > 10 K points, the first 10 K points of the waveform record becomes the FFT time domain record.
- Each FFT time domain record starts at the beginning of the acquired waveform record.
- The zero phase reference point for a phase FFT math waveform is in the middle of the FFT time domain record regardless of the waveform record length.

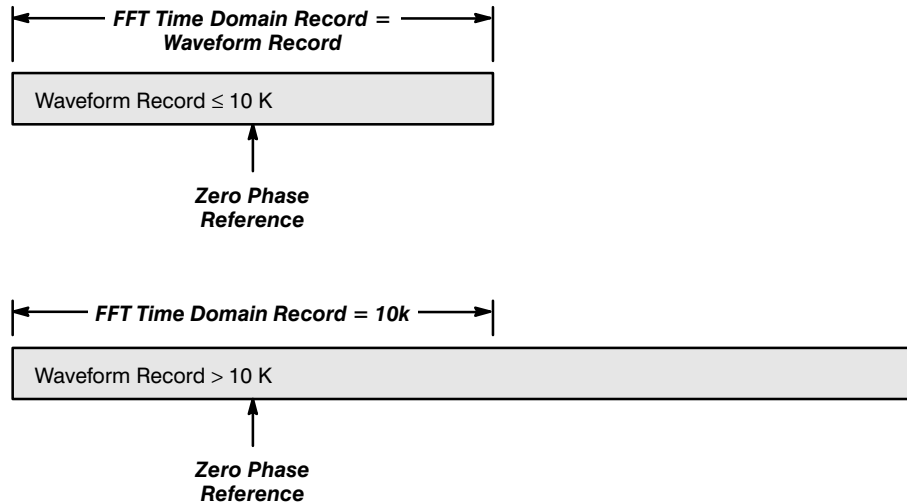

Figure 3-24: Waveform Record vs. FFT Time Domain Record

FFTs Transform Time Records to Frequency Records — The FFT time domain record just described is input for the FFT. Figure 3-25 shows the transformation of that time domain data record into an FFT frequency domain record. The resulting frequency domain record is one half the length of the FFT input because the FFT computes both positive and negative frequencies. Since the negative values mirror the positive values, only the positive values are displayed.

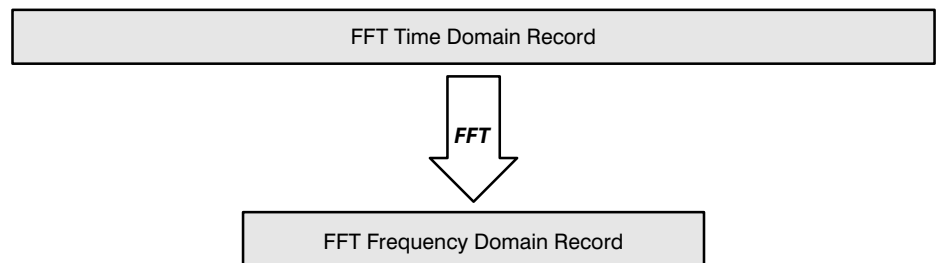

Figure 3-25: FFT Time Domain Record vs. FFT Frequency Domain Record

FFT Frequency Range and Resolution — When you turn on an FFT waveform, the oscilloscope displays either the magnitude or phase angle of the FFT frequency domain record. The resolution between the discrete frequencies displayed in this waveform is determined by the following equation:

$$\Delta F = \frac{\text{Sample Rate}}{\text{FFT Length}}$$

Where: ΔF is the frequency resolution.

Sample Rate is the sample rate of the source waveform.

FFT Length is the length of the FFT Time Domain waveform record.

The sample rate also determines the range these frequencies span; they span from 0 to $\frac{1}{2}$ the sample rate of the waveform record. (The value of $\frac{1}{2}$ the sample rate is often referred to as the Nyquist frequency or point.) For example, a sample rate of 20 Megasamples per second would yield an FFT with a range of 0 to 10 MHz. The sample rates available for acquiring data records vary over a range the limits of which depend on your oscilloscope model. TDS oscilloscopes display the sample rate in the acquisition readout at the top of the oscilloscope screen.

Offset, Position, and Scale

The following topics contain information to help you display your FFT properly.

Adjust for a Non-Clipped Display — To properly display your FFT waveform, scale the source waveform so it is not clipped.

- You should scale and position the source waveform so it is contained on screen. (Off screen waveforms may be clipped, resulting in errors in the FFT waveform).

Alternately, to get maximum vertical resolution, you can display source waveforms with amplitudes up to two divisions greater than that of the screen. If you do, turn on **Pk-Pk** in the measurement menu and monitor the source waveform for clipping.

- Use vertical position and vertical offset to position your *source* waveform. As long as the source waveform is not clipped, its vertical position and vertical offset will not affect your FFT waveform except at DC. (DC correction is discussed below.)

Adjust Offset and Position to Zero for DC Correction — Normally, the output of a standard FFT computation yields a DC value that is twice as large as it should be with respect to the other frequencies. Also, the selection of window type introduces errors in the DC value of an FFT.

The displayed output of the FFT on TDS oscilloscopes is corrected for these errors to show the true value for the DC component of the input signal. The **Position** and **Offset** must be set to zero for the source waveform in the Vertical menu. When measuring the amplitude at DC, remember that 1 VDC equals 1 V_{RMS} and the display is in dB.

Record Length

Most often, you will want to use a short record length because more of the FFT waveform can be seen on screen and long record lengths can slow oscilloscope response. However, long record lengths lower the noise relative to the signal and increase the frequency resolution for the FFT. More important, they might be needed to capture the waveform feature you want to include in the FFT.

To speed up oscilloscope response when using long record lengths, you can save your source waveform in a reference memory and perform an FFT on the saved waveform. That way the DSP will compute the FFT based on saved, static data and will only update if you save a new waveform.

Acquisition Mode

Selecting the right acquisition mode can produce less noisy FFTs.

Set up in Sample or Normal Mode — Use sample mode until you have set up and turned on your FFT. Sample mode can acquire repetitive and nonrepetitive waveforms and does not affect the frequency response of the source waveform.

Hi Res and Average Reduce Noise — After the FFT is set up and displayed, it might be useful to turn on Hi Res mode, on TDS models so equipped, to reduce the effect of noise in the signal. Hi Res operates on both repetitive and nonrepetitive waveforms; however, it does affect the frequency response of the source waveform.

If the pulse is repetitive, Average mode may be used to reduce noise in the signal at a cost of slower display response. Average operates on repetitive waveforms only, and averaging does affect the frequency response of the source waveform.

Peak Detect (on TDS models so equipped) and Envelope mode can add significant distortion to the FFT results and are not recommended for use with FFTs.

Zoom and Interpolation

Once you have your waveform displayed optimally, you may magnify (or reduce) it vertically and horizontally to inspect any feature you desire. Just be sure the FFT waveform is the selected waveform. (Press **MORE**, then select the FFT waveform in the More main menu. Then use the Vertical and Horizontal **SCALE** knobs to adjust the math waveform size.)

If you wish to see the zoom factor (2X, 5X, etc.) you need to turn Zoom on: press **ZOOM → On** (side). The vertical and horizontal zoom factors appear on screen.

Whether Zoom is on or off, you can press **Reset Zoom Factors** (side) to return the zoomed FFT waveform to no magnification.

Zoom always uses either $\sin(x)/x$ or linear interpolation when expanding displayed waveforms. To select the interpolation method: press **DISPLAY** → **Setting** (main) → **Display** (pop-up) → **Filter** (main) → **Sin(x)/x** or **Linear** (side), or if your oscilloscope does not have color, press **DISPLAY** → **Filter** (main) → **Sin(x)/x** or **Linear** (side)

If the source waveform record length is 500 points, the FFT will use 2X Zoom to increase the 250 point FFT frequency domain record to 500 points. Therefore, FFT math waveforms of 500 point waveforms are always zoomed 2X or more with interpolation. Waveforms with other record lengths can be zoomed or not and can have minimum Zooms of 1X or less.

$\sin(x)/x$ interpolation may distort the magnitude and phase displays of the FFT depending on which window was used. You can easily check the effects of the interpolation by switching between $\sin(x)/x$ and linear interpolation and observing the difference in measurement results on the display. If significant differences occur, use linear interpolation.

Undersampling (Aliasing)

Aliasing occurs when the oscilloscope acquires a source waveform with frequency components outside of the frequency range for the current sample rate. In the FFT waveform, the actual higher frequency components are undersampled, and therefore, they appear as lower frequency aliases that “fold back” around the Nyquist point (see Figure 3-26).

The greatest frequency that can be input into any sampler without aliasing is $\frac{1}{2}$ the sample frequency. Since source waveforms often have a fundamental frequency that does not alias but have harmonic frequencies that do, you should have methods for recognizing and dealing with aliases:

- Be aware that a source waveform with fast edge transition times creates many high frequency harmonics. These harmonics typically decrease in amplitude as their frequency increases.
- Sample the source signal at rates that are at least 2X that of the highest frequency component having significant amplitude.
- Filter the input to bandwidth limit it to frequencies below that of the Nyquist frequency.
- Recognize and ignore the aliased frequencies.

If you think you have aliased frequencies in your FFT, select the source channel and adjust the horizontal scale to increase the sample rate. Since you increase the Nyquist frequency as you increase the sample rate, the alias signals should appear at their proper frequency.

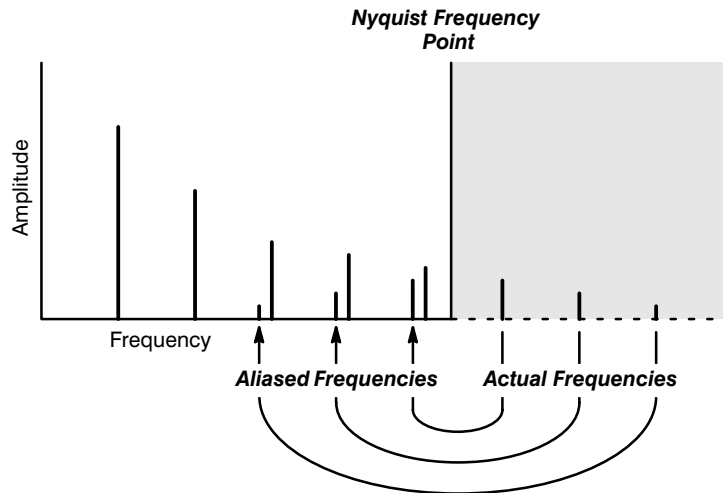

Figure 3-26: How Aliased Frequencies Appear in an FFT

Considerations for Phase Displays

When you set up an FFT math waveform to display the phase angle of the frequencies contained in a waveform, you should take into account the reference point the phase is measured against. You may also need to use phase suppression to reduce noise in your FFTs.

Establish a Zero Phase Reference Point — The phase of each frequency is measured with respect to the zero phase reference point. The zero reference point is the point at the center of the FFT math waveform but corresponds to various points on the *source* (time domain) record. (See Figure 3-24 on page 3-43.)

To measure the phase relative to most source waveforms, you need only to center the positive peak around the zero phase point. (For instance, center the positive half cycle for a sine or square wave around the zero phase point.) Use the following method:

- First be sure the FFT math waveform is selected in the More menu, then set horizontal position to 50% in the Horizontal menu. This positions the zero phase reference point to the horizontal center of the screen.
- In the Horizontal menu, vary the trigger position to center the positive peak of the source waveform at the horizontal center of screen. Alternatively, you can adjust the trigger level (knob) to bring the positive peak to center screen if the phase reference waveform has slow enough edges.

When impulse testing and measuring phase, align the impulse input into the system to the zero reference point of the FFT time domain waveform:

- Set the trigger position to 50% and horizontal position to 50% for all record lengths less than 15 K. (Your model oscilloscope may not have record lengths of 15 K or longer — consult your User manual.)

- For records with a 15 K length, set the trigger position to 33%. Use the horizontal position knob to move the trigger T on screen to the center horizontal graticule line.
- For records with 30 K, 50 K, or 60 K lengths (not all lengths are available for all TDS models — consult your User manual), set the trigger position to 16.6%, 10%, or 8.3%, respectively. Use the horizontal position knob to move the trigger T on screen and to the center horizontal graticule line.
- Trigger on the input impulse.

Adjust Phase Suppression — Your source waveform record may have a noise component with phase angles that randomly vary from $-\pi$ to π . This noise could make the phase display unusable. In such a case, use phase suppression to control the noise.

You specify the phase suppression level in dB with respect to $1 V_{RMS}$. If the magnitude of the frequency is greater than this threshold, then its phase angle will be displayed. However, if it is less than this threshold, then the phase angle will be set to zero and be displayed as zero degrees or radians. (The waveform reference indicator at the left side of the graticule indicates the level where phase is zero for phase FFTs.)

It is easier to determine the level of phase suppression you need if you first create a *frequency* FFT math waveform of the source and then create a *phase* FFT waveform of the same source. Do the following steps to use a cursor measurement to determine the suppression level:

1. Do steps 1 through 7 of *Operation* that begins on page 3-37. Select **dBV RMS** (side) for the **Set FFT Vert Scale to** (side).
2. Press **CURSOR** → **Mode** (main) → **Independent** (side) → **Function** (main) → **H Bars** (side). Use the general purpose knob to align the selected cursor to a level that places the tops of the magnitudes of frequencies of interest above the cursor but places other magnitudes completely below the cursor.
3. Read the level in dB from the @: readout. Note the level for use in step 5.
4. Press **MORE** (main) → **Change Waveform Definition menu** (side). Press **Set FFT Vert Scale to** (side) repeatedly to choose either **Phase (rad)** or **Phase (deg)**.
5. Press **Suppress Phase at Amplitudes** (side). Use the general purpose knob (or keypad if your oscilloscope is so equipped) to set phase suppression to the value obtained using the H Bar cursor. Do not change the window selection or you will invalidate the results obtained using the cursor.

FFT Windows

To learn how to optimize your display of FFT data, read about how the FFT windows data before computing the FFT math waveform. Understanding FFT windowing can help you get more useful displays.

Windowing Process — The oscilloscope multiplies the FFT time domain record by one of four FFT windows before it inputs the record to the FFT function. Figure 3-27 shows how the time domain record is processed.

The FFT windowing acts like a bandpass filter between the FFT time domain record and the FFT frequency domain record. The shape of the window controls the ability of the FFT to resolve (separate) the frequencies and to accurately measure the amplitude of those frequencies.

Selecting a Window — You can select your window to provide better frequency resolution at the expense of better amplitude measurement accuracy in your FFT, better amplitude accuracy over frequency resolution, or to provide a compromise between both. You can choose from these four windows: Rectangular, Hamming, Hanning, and Blackman-Harris.

In step 8 (page 3-38) in *Displaying an FFT*, the four windows are listed in order according to their ability to resolve frequencies versus their ability to accurately measure the amplitude of those frequencies. The list indicates that the ability of a given window to resolve a frequency is inversely proportional to its ability to accurately measure the amplitude of that frequency. In general, then, choose a window that can just resolve between the frequencies you want to measure. That way, you will have the best amplitude accuracy and leakage elimination while still separating the frequencies.

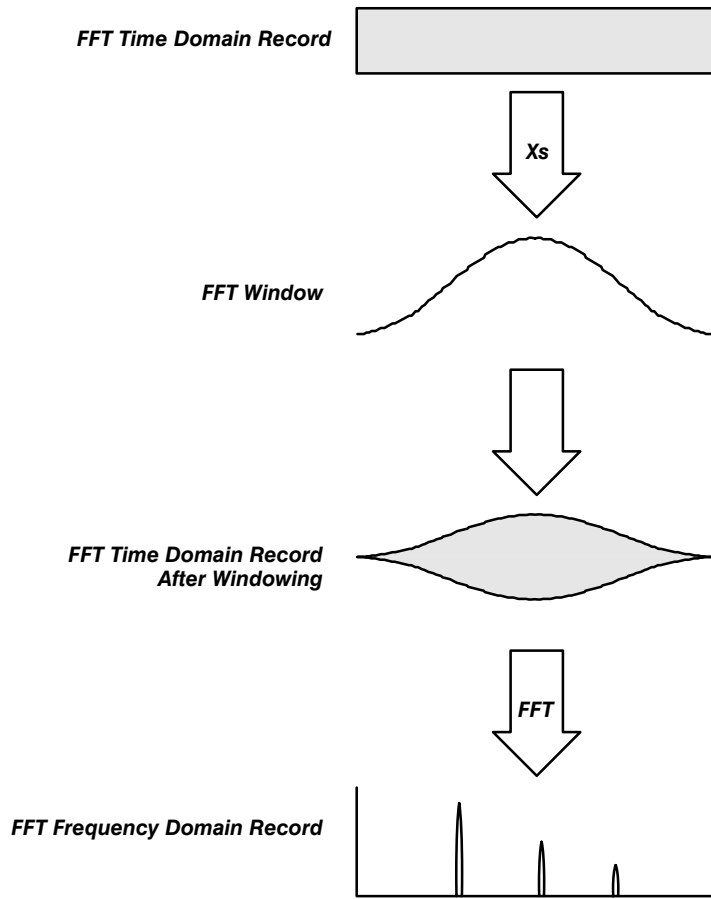

Figure 3-27: Windowing the FFT Time Domain Record

You can often determine the best window empirically by first using the window with the most frequency resolution (rectangular), then proceeding toward that window with the least (Blackman-Harris) until the frequencies merge. Use the window just before the window that lets the frequencies merge for best compromise between resolution and amplitude accuracy.

NOTE

If the Hanning window merges the frequencies, try the Hamming window before settling on the rectangular window. Depending on the distance of the frequencies you are trying to measure from the fundamental, the Hamming window sometimes resolves frequencies better than the Hanning.

Window Characteristics — When evaluating a window for use, you may want to examine how it modifies the FFT time domain data. Figure 3-28 shows each window, its bandpass characteristic, bandwidth, and highest side lobe. Consider the following characteristics:

- The narrower the central lobe for a given window, the better it can resolve a frequency.
- The lower the lobes on the side of each central lobe are, the better the amplitude accuracy of the frequency measured in the FFT using that window.
- Narrow lobes increase frequency resolution because they are more selective. Lower side lobe amplitudes increases accuracy because they reduce leakage.

Leakage results when the FFT time domain waveform delivered to the FFT function contains a non-integer number of waveform cycles. Since there are fractions of cycles in such records, there are discontinuities at the ends of the record. These discontinuities cause energy from each discrete frequency to “leak” over on to adjacent frequencies. The result is amplitude error when measuring those frequencies.

The rectangular window does not modify the waveform record points; it generally gives the best frequency resolution because it results in the most narrow lobe width in the FFT output record. If the time domain records you measured always had an integer number of cycles, you would only need this window.

Hamming, Hanning, and Blackman-Harris are all somewhat bell-shaped windows that taper the waveform record at the record ends. The Hanning and Blackman/Harris windows taper the data at the end of the record to zero; therefore, they are generally better choices to eliminate leakage.







FFT Window Type	Bandpass Filter	-3 dB Bandwidth	Highest Side Lobe
 <p>Rectangular Window</p>		0.89	-13 dB
 <p>Hamming Window</p>		1.28	-43 dB
 <p>Hanning Window</p>		1.28	-32 dB
 <p>Blackman-Harris Window</p>		1.28	-94 dB

Figure 3-28: FFT Windows and Bandpass Characteristics

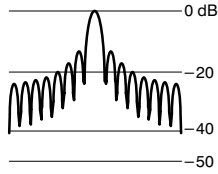
Care should be taken when using bell shaped widows to be sure that the most interesting parts of the signal in the time domain record are positioned in the center region of the window so that the tapering does not cause severe errors.

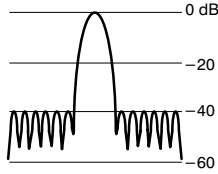
For More Information

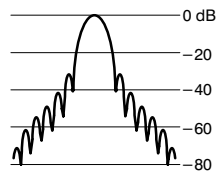
- See *Waveform Differentiation*, on page 3-139.
- See *Waveform Integration*, on page 3-143.
- See *Waveform Math*, on page 3-148.

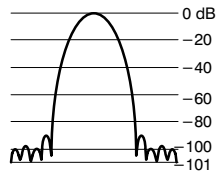
File System (Optional on TDS 620A & TDS 640A)

The File Utilities menu, which comes with the Hardcopy, Save Setup, and Save Waveforms menus, gives you a variety of features for managing the floppy disk.

Operation

The File Utilities menu lets you delete, rename, copy, print files, create a new directory, operate the confirm delete and overwrite lock, and format disks.

To bring up the File Utilities menu:

1. Press the **SETUP** button to bring up the Save/Recall Setup menu, or press the **WAVEFORM** button to bring up the Save/Recall Waveform menu, or press the **Shift HARDCOPY** button to bring up the Hardcopy menu.
2. Press **File Utilities** in the main menu to bring up the File Utilities side menu. (see Figure 3-29).

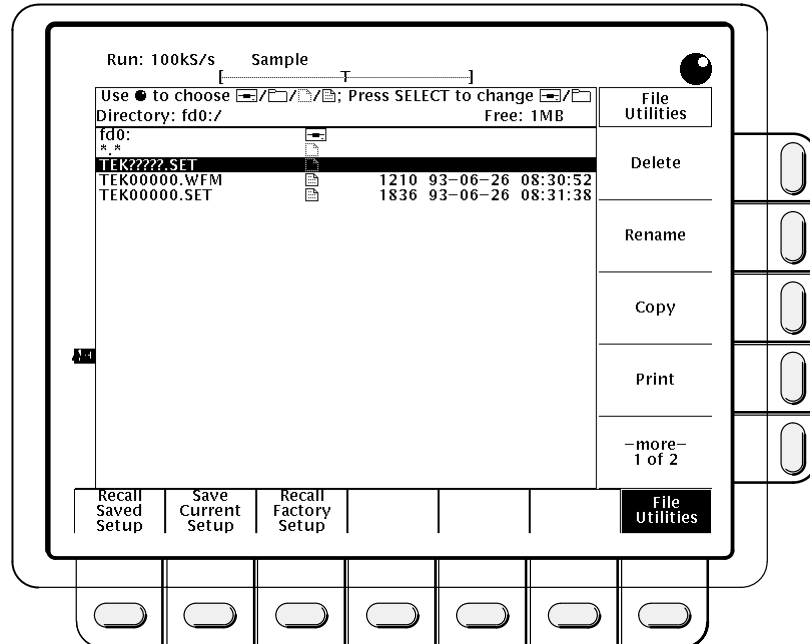

Figure 3-29: File Utilities

NOTE

*The amount of free space on the disk is shown in the upper right corner of the display. The digitizing oscilloscope shows the amount in K bytes. To convert the amount to bytes, you simply multiply the K bytes amount times 1024. Thus, the 711 kB shown in Figure 3-29 = 711 Kbytes * 1024 bytes/K = 728,064 bytes.*

Delete

To delete a file or directory, turn the general purpose knob until it scrolls the cursor over the name of the file or directory to delete. Then, press the side menu **Delete** button.

To delete all files in the file list, set the cursor to the *.* selection.

The digitizing oscilloscope deletes directories recursively. That means it deletes both the directories and all their contents.

Rename

To rename a file or directory, turn the general purpose knob until it scrolls the cursor over the name of the file or directory to delete. For example, to rename the target file whose default name is `TEK?????` set the cursor over its name. Then, press the side menu **Rename** button.

The labelling menu should appear. Turn the general purpose knob or use the main-menu arrow keys to select each letter. Press **Enter Char** from the main menu to enter each letter. When you have entered the name, press the side menu **OK Accept** item (See Figure 3-30).

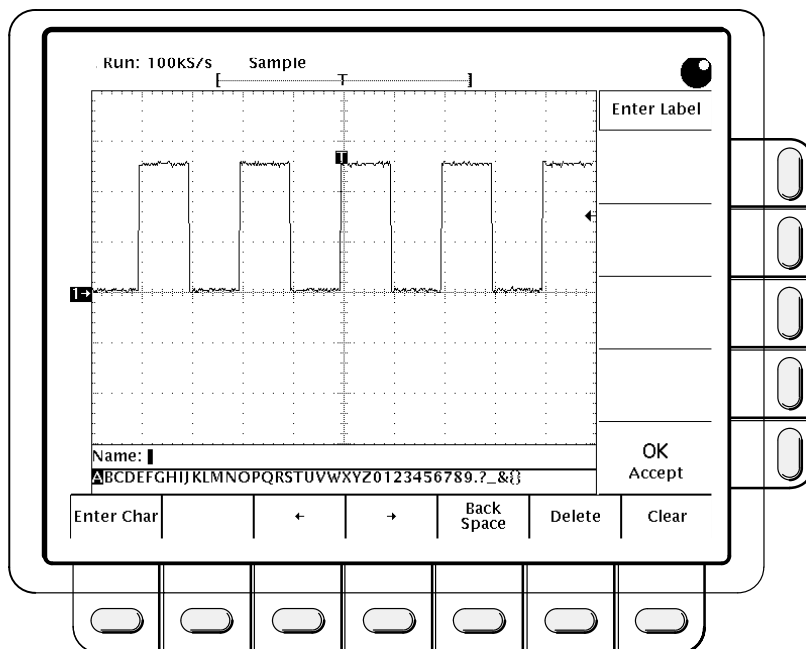

Figure 3-30: File System — Labelling Menu

Copy

To copy a file or directory, turn the general purpose knob until it scrolls the cursor over the name of the file to copy. Then, press the side menu **Copy** button. The file menu will reappear with the names of directories to copy to. Select a directory and press the side-menu button labelled **Copy <name> to Selected Directory**.

To copy all files, select the *.* entry.

The digitizing oscilloscope copies all directories recursively. That means it copies both the directories and all their contents.

Print

To print a file, turn the general purpose knob until it scrolls the cursor over the name of the file to print. Then, press the side-menu **Print** button.

The Print-To side menu should appear. Select the port to print to from **GPIB**, **RS-232**, or **Centronics**. (See Figure 3-30) Then the digitizing oscilloscope will send the file in its raw form out the port. The device (printer) receiving the file must be capable of printing the particular file format.

Create Directory

To create a new directory, press the side menu **Create Directory** button.

The labelling menu should appear. Turn the general purpose knob or use the main-menu arrow keys to select each letter. Press **Enter Char** from the main menu to enter each letter. When you have entered the name, press the side menu **OK Accept** item. (See Figure 3-30)

Confirm Delete

To turn on or off the confirm delete message, toggle the side menu **Confirm Delete** button.

When the confirm delete option is OFF, the digitizing oscilloscope can immediately delete files or directories. When the confirm option is ON, the digitizing oscilloscope warns you before it deletes files and gives you a chance to reconsider

Overwrite Lock

To turn on or off the file overwrite lock, toggle the side menu **Overwrite Lock** button.

When overwrite lock is on, the digitizing oscilloscope will not permit you to write over an existing file of the same name. An important reason to allow overwriting is to let you write files using a target file name that contains wild card characters (“?”). This means the digitizing oscilloscope creates sequential files whose names are similar except for the sequential numbers that go in the real name in the place of the question marks.

Format

To format a 720 Kbyte or 1.44 Mbyte disk, turn the general purpose knob until it scrolls the cursor over the name of the drive to format in. (fd0:) Then, press the side menu **Format** button.

Hardcopy

You can get a copy of the digitizing oscilloscope display by using the hard-copy feature. Depending on the output format you select, you create either an image or a plot. Images are direct bit map representations of the digitizing oscilloscope display. Plots are vector (plotted) representations of the display.

Hardcopy Formats

Different hardcopy devices use different formats. The digitizing oscilloscope supports the following formats:

- HP Thinkjet inkjet printer
- HP Deskjet inkjet printer
- HP Laserjet laser printer
- Epson
- DPU-411/II portable thermal printer
- DPU-412 portable thermal printer
- PCX (PC Paintbrush)
- PCX Color (PC Paintbrush) (TDS 644A)
- TIFF (Tag Image File Format)
- BMP Mono (Microsoft Windows file format)
- BMP Color (Microsoft Windows file format) (TDS 644A)
- RLE Color (Microsoft Windows color image file format – compressed) (TDS 644A)
- EPS Mono Image (Encapsulated Postscript, mono-image)
- EPS Color Image (Encapsulated Postscript, color-image) (TDS 644A)
- EPS Mono Plot (Encapsulated Postscript, mono-plot)
- EPS Color Plot (Encapsulated Postscript, color-plot)
- Interleaf
- HPGL Color Plot

Some formats, particularly Interleaf, EPS, TIFF, PCX, BMP, and HPGL, are compatible with various desktop publishing packages. That means you can paste files created from the oscilloscope directly into a document on any of those desktop publishing systems.

EPS Mono and Color formats are compatible with Tektronix Phaser Color Printers, HPGL is compatible with the Tektronix HC100 Plotter, and Epson is compatible with the Tektronix HC220 Printer.

Operation

Before you make a hardcopy, you need to set up communications and hardcopy parameters. This discussion assumes that the hardcopy device is already connected to the GPIB port on the rear panel. If that is not the case see *Connection Strategies* on page 3-61.

Setting Communication Parameters

To set up the communication parameters to talk to a printer attached directly to the oscilloscope GPIB port:

Press **SHIFT UTILITY** → **System** (main) → **I/O** (pop-up) → **Port** → **GPIB** (pop-up) → **Configure** (main) → **Hardcopy (Talk Only)** (side).

To set up the communication parameters to talk to a printer attached directly to the oscilloscope RS-232 port:

Press **SHIFT UTILITY** → **System** (main) → **I/O** (pop-up) → **Port** → **RS232** (pop-up) → **Hardware Setup** (main).

Press the side-menu **Baud Rate**, **Stop Bits**, **Parity** and **Hard Flagging** items and enter data as desired to match the hardcopy device (see Figure 3-31).

Press **Software Setup** (main) and toggle the side-menu **Soft Flagging** item to turn software flagging on or off as desired.

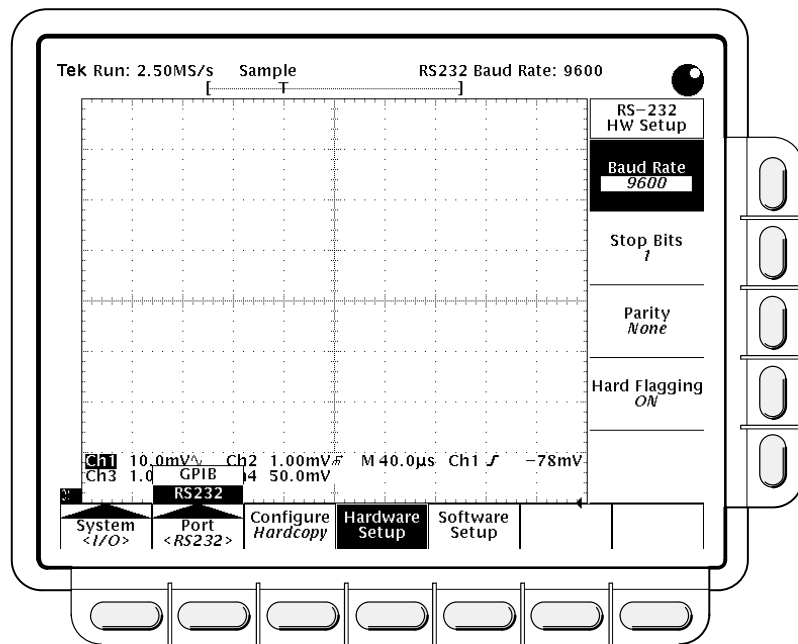

Figure 3-31: Utility Menu — System I/O

Setting Hardcopy Parameters

To specify the hardcopy format, layout, and type of port using the hardcopy menu:

1. Press **SHIFT HARDCOPY MENU** to bring up the Hardcopy menu.
2. Press **Format** (main) → **Thinkjet, Deskjet, Laserjet, Epson, DPU-411, DPU-412, PCX, PCX Color** (TDS 644A), **TIFF, BMP Mono, BMP Color** (TDS 644A), **RLE Color** (TDS 644A), **EPS Mono Img, EPS Color Image** (TDS 644A), **EPS Mono Plt, EPS Color Plt, Interleaf, or HPGL** (side). (Press **–more–** (side) to see all of these format choices.)
3. Press **SHIFT HARDCOPY MENU** → **Layout** (main) → **Landscape** or **Portrait** (side) (see Figure 3-32).

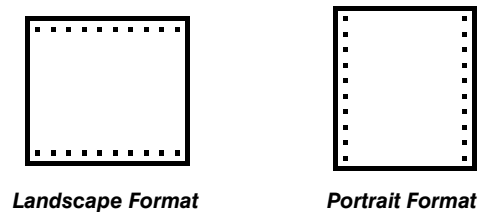

Figure 3-32: Hardcopy Formats

4. Press **SHIFT HARDCOPY MENU** → **Port** (main) to specify the output channel to send your hardcopy through. The choices are **GPIOB, RS-232, Centronics, and File** (RS-232, Centronics, and File are optional on the TDS 620A & TDS 640A).

If you choose **File**, the file-list scrollbar will appear. Turn the general purpose knob to select the desired file.

5. For hardcopy formats that support palettes, press **SHIFT HARDCOPY MENU** → **Palette** (main) → **Hardcopy** or **Current** (side). Choose **Hardcopy** to have the hardcopy created using the Hardcopy Preview palette in the Color Palette menu. The default settings for this palette provide a white background. Choose **Current** to have the hardcopy created in colors that closely match the current display.

Printing the Hardcopy

You can print a single hardcopy or send additional hardcopies to the spool (queue) while waiting for earlier hardcopies to finish printing. To print your hardcopy(ies):

Press **HARDCOPY** to print your hardcopy.

While the hardcopy is being sent to the printer, the oscilloscope will display the message “Hardcopy in process — Press **HARDCOPY** to abort.”

To stop and discard the hardcopy being sent, press **HARDCOPY** again *while* the hardcopy in process message is still on screen.

To add additional hardcopies to the printer spool, press **HARDCOPY** again *after* the hardcopy in process message is removed from the screen.

You can add hardcopies to the spool until it is full. When the spool is filled by adding a hardcopy, the message “Hardcopy in Process — Press **HARDCOPY** to abort” remains displayed. You can abort the *last* hardcopy sent by pressing the button while the message is still displayed. When the printer empties enough of the spool to finish adding the last hardcopy it does so and then removes the message.

To remove all hardcopies from the spool:

Press **SHIFT HARDCOPY MENU** → **Clear Spool** (main) → **OK Confirm Clear Spool** (side).

This oscilloscope takes advantage of any unused RAM when spooling hardcopies to printers. The size of the spool is, therefore, variable. The number of hardcopies that can be spooled depends on three variables:

- the amount of unused RAM
- the hardcopy format chosen
- the complexity of the display

Although not guaranteed, usually about 2.5 hardcopies can be spooled before the oscilloscope must wait to send the rest of the third copy.

Date/Time Stamping Your Hardcopy

You can display the current date and time on screen so that they appear on the hardcopies you print. To date and time stamp your hardcopy:

1. Press **DISPLAY** → **Readout Options** (main) → **Display Date and Time** (side) to toggle the setting to **On**.
2. Press **Clear Menu** to remove the menu from the display so the date and time can be displayed (see Figure 3-33). (The date and time are removed from the display when menus are displayed.)
3. Press **HARDCOPY** to print your date/time stamped hardcopy.

If you need to set the date and time of the oscilloscope:

4. Press **SHIFT UTILITY** → **Config** (pop-up) → **Set Date & Time** (main) → **Year, Day Month, Hour, or Minute**.

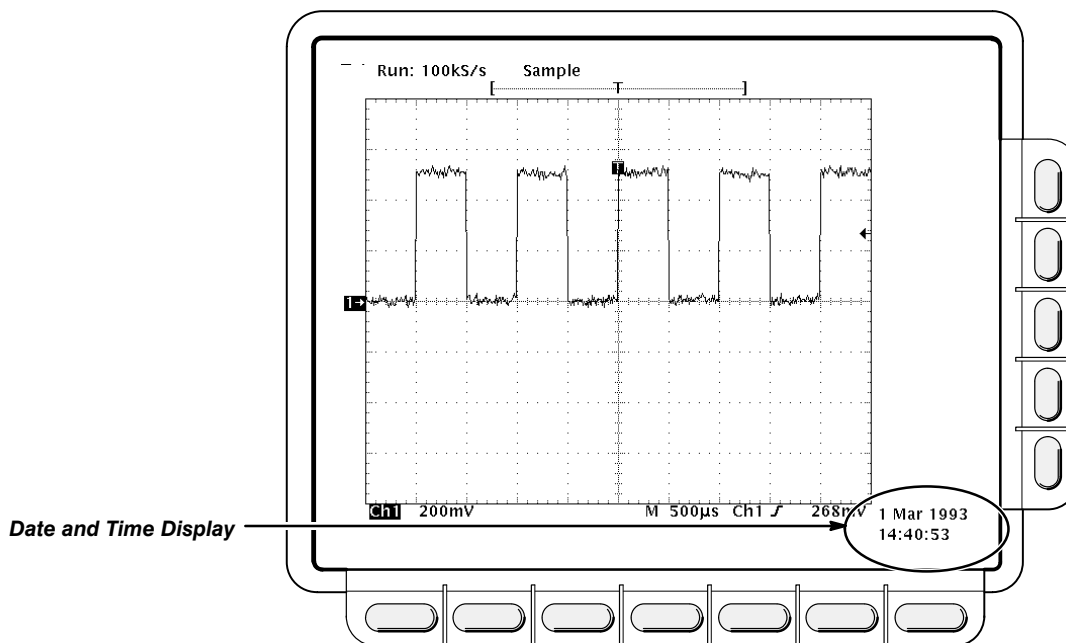

Figure 3-33: Date and Time Display

5. Use the general purpose knob or the keypad to set the parameter you have chosen to the value desired. (The format when using the keypad is day.month. For example, use 23.6 for the 23rd of June.)
6. Repeat steps 4 and 5 to set other parameters as desired.
7. Press **OK Enter Date/Time** (side) to put the new settings into effect. This sets the seconds to zero.

NOTE

*When setting the clock, you can set to a time slightly later than the current time and wait for it to catch up. When current time catches up to the time you have set, pressing **Ok Enter Date/Time** (side) synchronizes the set time to the current time.*

8. Press **CLEAR MENU** to see the date/time displayed with the new settings.
9. Press **HARDCOPY** to print your date/time stamped hardcopy.

Connection Strategies

The ability of the digitizing oscilloscope to print a copy of its display in many formats (see page 3-57) gives you flexibility in choosing a hardcopy device. It also makes it easier for you to place oscilloscope screen copies into a desktop publishing system.

Strategies for actually printing a copy include:

- Send output straight to a printer/plotter.
- Send the data to a computer to print from there and/or to import into your favorite desktop publishing or other application package.
- Send your data to a floppy disk file (optional on the TDS 620A & TDS 640A) for later printing from a computer capable of reading the MS-DOS compatible floppy disk.

Printing Directly to a Hardcopy Device

You can connect the digitizing oscilloscope directly to a hardcopy device (see Figure 3-34). An example of a GPIB hardcopy device is the Tektronix HC100 Plotter. Many printers, such as the Tektronix HC220, use Centronics interfaces. Many hardcopy devices, including the HC100 with option 03, provide RS-232 support.

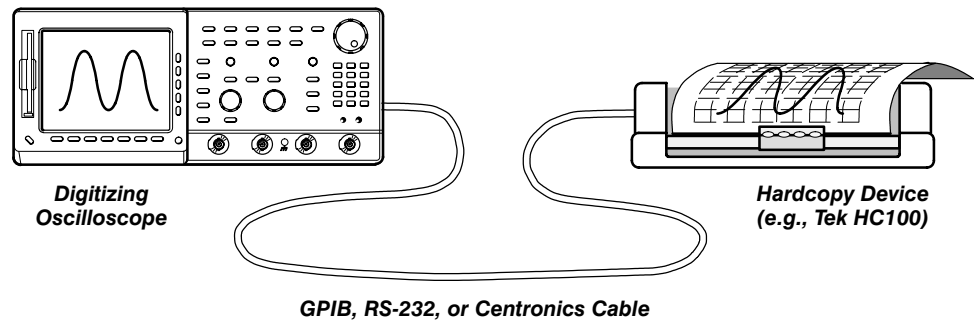

Figure 3-34: Connecting the Digitizing Oscilloscope Directly to the Hardcopy Device

Using a Controller

You can put a controller with two ports between the digitizing oscilloscope and the hardcopy device (see Figure 3-35). Use a GPIB port to remotely request and receive a hardcopy from the digitizing oscilloscope. Use an RS-232 or a Centronics port on the controller to print output.

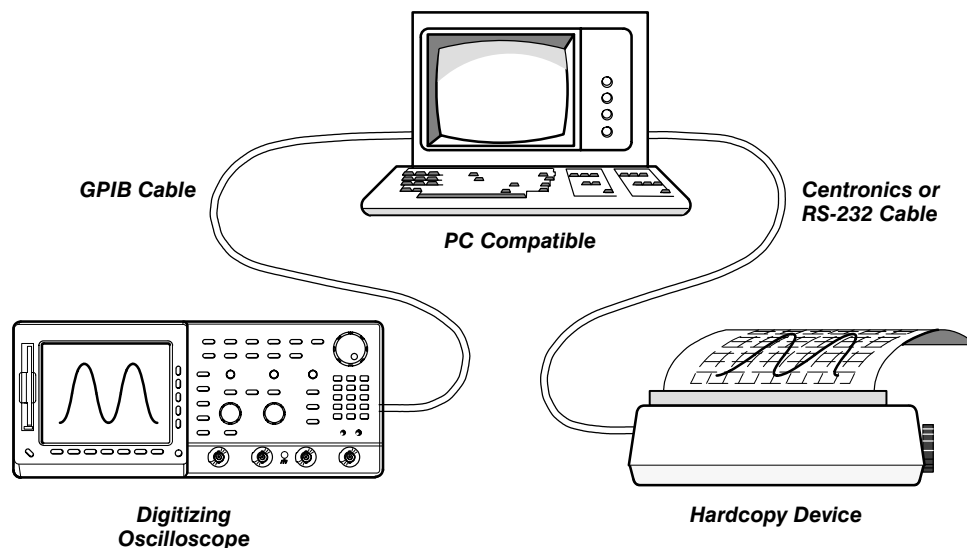

Figure 3-35: Connecting the Digitizing Oscilloscope and Hardcopy Device Via a PC

If your controller is PC-compatible and it uses the Tektronix GURU or S3FG210 (National Instruments GPIB-PCII/IIA) GPIB package, you can operate this setup as follows:

1. Use the MS-DOS `cd` command to move to the directory that holds the software that came with your GPIB board. For example, if you installed the software in the GPIB-PC directory, type: **cd GPIB-PC**
2. Run the IBIC program that came with your GPIB board. Type: **IBIC**
3. Type: **IBFIND DEV1** where "DEV1" is the name for the digitizing oscilloscope you defined using the IBCONF.EXE program that came with the GPIB board.

NOTE

If you defined another name then, of course, use it instead of "DEV1". Also, remember that the device address of the digitizing oscilloscope as set with the IBCONF.EXE program should match the address set in the digitizing oscilloscope Utility menu (typically, use "1").

4. Type: **IBWRT "HARDCOPY START"** Be sure the digitizing oscilloscope Utility menu is set to **Talk/Listen** and not **Hardcopy (Talk Only)** or you will get an error message at this step. Setting the digitizing oscilloscope Utility menu was described in the start of this Hardcopy section under the heading *Setting Communication Parameters*. Be sure to set the controller time-out longer than the time required to transfer the hardcopy.

Hardcopy

5. Type: **IBRDF <Filename>** where <Filename> is a valid DOS file name you want to call your hardcopy information. It should be ≤ 8 characters long with up to a 3 character extension. For example, you could type *"ibrdf screen1"*.
6. Exit the IBIC program by typing: **EXIT**
7. Type: **COPY <Filename> <Output port> ** where <Filename> is the name you defined in step 5 and <Output port> is the PC output port your hardcopy device is connected to (such as LPT1 or LPT2). Copy the data from your file to your hardcopy device. First, ensure your printer or plotter is properly attached to your PC. Then copy the file. For example, if your file is called *screen1* and your printer is attached to the *lpt1* parallel port, type *"copy screen1 lpt1: /B"*.

NOTE

If you transmit hardcopy files across a computer network, use a binary (8-bit) data path.

Your hardcopy device should now print a picture of the digitizing oscilloscope screen.

For More Information

See *Remote Communication*, on page 3-116.

Help

The on-line help system provides brief information about each of the digitizing oscilloscope controls.

Operation

To use the on-line help system:

Press **HELP** to provide on-screen information on any front panel button, knob or menu item (see Figure 3-36).

When you press that button, the instrument changes mode to support on-line help. Press **HELP** again to return to regular operating mode. Whenever the oscilloscope is in help mode, pressing any button (except **HELP** or **SHIFT**), turning any knob, or pressing any menu item displays help text on the screen that discusses that control.

The menu selections that were displayed when **HELP** was first pressed remain on the screen. On-line help is available for each menu selection displayed at the time the **HELP** button was first pressed. If you are in help mode and want to see help on selections from non-displayed menus, you first exit help mode, display the menu you want information on, and press **HELP** again to re-enter help mode.

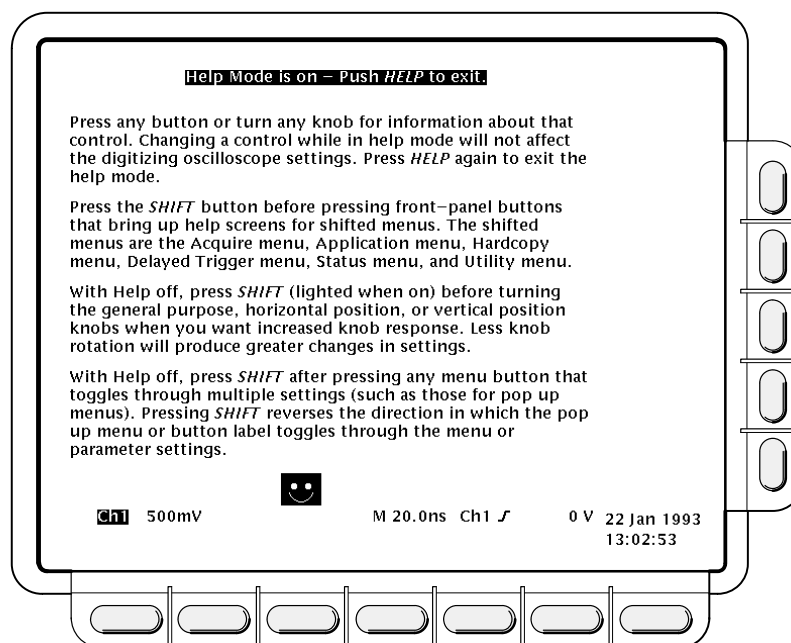

Figure 3-36: Initial Help Screen

Horizontal Control

You can control the horizontal part of the display (the time base) using the horizontal menu and knobs.

Horizontal Knobs

By changing the horizontal scale, you can focus on a particular portion of a waveform. By adjusting the horizontal position, you can move the waveform right or left to see different portions of the waveform. That is particularly useful when you are using larger record sizes and cannot view the entire waveform on one screen.

To change the horizontal scale and position, use the horizontal **POSITION** and horizontal **SCALE** knobs (see Figure 3-37). These knobs manage the time base and horizontal waveform positioning on the screen. When you use either the horizontal **SCALE** or **POSITION** knobs, you affect all the waveform records displayed.

When you use either the horizontal **SCALE** or **POSITION** knobs, you affect all displayed waveform records. If you want the **POSITION** knob to move faster, press the **SHIFT** button. When the light above the shift button is on and the display says **Coarse Knobs** in the upper right corner, the **POSITION** knob speeds up significantly.

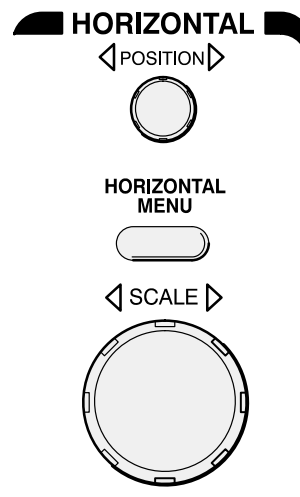

Figure 3-37: Horizontal Controls

Horizontal Readouts

At the top of the display, the *Record View* shows the size and location of the waveform record and the location of the trigger relative to the display (see Figure 3-38). The *Time Base readout* at the lower right of the display shows the time/division settings and the time base (main or delayed) being referred to (see Figure 3-38).

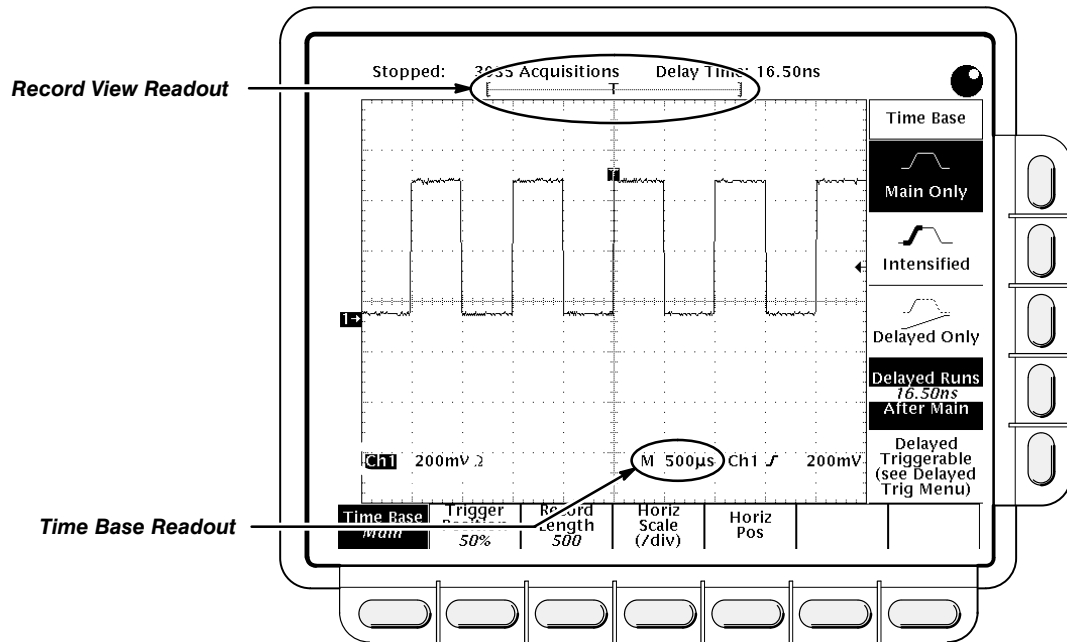

Figure 3-38: Record View and Time Base Readouts

Horizontal Menu

The Horizontal menu lets you select either a main or delayed view of the time base for acquisitions. It also lets you set the record length, set the trigger position, and change the position or scale.

Main and Delayed Time Base

To select between the Main and Delayed views of the time base:

Press **HORIZONTAL MENU** → **Time Base** (main) → **Main Only**, **Intensified**, or **Delayed Only** (side).

By pressing **Intensified**, you display a colored or intensified zone that shows where the delayed trigger record length could occur relative to the main trigger. The start of the zone corresponds to the possible start point of the delayed trigger. The end of the zone corresponds to the end of the delayed view of the time base.

You also can select **Delayed Runs After Main** or **Delayed Triggerable**. For more information on how to use these two menu items, see *Delayed Triggering* on page 3-20.

Trigger Position

To define how much of the record will be pretrigger and how much posttrigger information using the **Trigger Position** menu item:

Press **HORIZONTAL MENU** → **Trigger Position** (main) → **Set to 20%**, **Set to 50%**, or **Set to 80%** (side), or use the general purpose knob or the keypad to change the value.

Record Length and Fit To Screen

To set the waveform record length, press **HORIZONTAL MENU** → **Record Length** (main). The side menu lists various discrete record length choices.

To fit an acquired waveform to the visible screen, regardless of record length, press **HORIZONTAL MENU** → **Record Length** (main). Then toggle **Fit to Screen** to **ON** from the side menu. This provides similar functionality to being in zoom mode and changing the time/division until the waveform fits the screen. To turn off this feature, toggle **Fit to Screen** to **OFF**.

Horizontal Scale

To change the horizontal scale (time per division) numerically in the menu instead of using the Horizontal **SCALE** knob:

Press **HORIZONTAL MENU** → **Horiz Scale** (main) → **Main Scale** or **Delayed Scale** (side), and use the keypad or the general purpose knob to change the scale values.

Horizontal Position

You can set the horizontal position to specific values in the menu instead of using the Horizontal **POSITION** knob.

Press **HORIZONTAL MENU** → **Horiz Pos** (main) → **Set to 10%**, **Set to 50%** or **Set to 90%** (side) to choose how much of the waveform will be displayed to the left of the display center.

You can also control whether changing the horizontal position setting affects all displayed waveforms, just the live waveforms, or only the selected waveform. The Horizontal Lock setting in the Zoom menu determines which waveforms the horizontal position knob adjusts whether zoom is on or not. Specifically, it acts as follows:

- **None** — only the waveform currently selected can be zoomed and positioned horizontally
- **Live** — all channels (including **AUX** channels for the TDS 620A) can be zoomed and positioned horizontally at the same time

- **All** — all waveforms displayed (channels, math, and/or reference) can be zoomed and positioned horizontally at the same time

See *Zoom*, on page 3-151 for the steps to set the horizontal lock feature.

For More Information

See *Scaling and Positioning Waveforms*, on page 2-22.

See *Delayed Triggering*, on page 3-20.

See *Zoom*, on page 3-151.

See *Display Modes*, on page 3-26.

Limit Testing

Limit testing provides a way to automatically compare each incoming or math waveform against a template waveform. You set an envelope of limits around a waveform and let the digitizing oscilloscope find waveforms that fall outside those limits (see Figure 3-39). When it finds such a waveform, the digitizing oscilloscope can generate a hardcopy, ring a bell, stop and wait for your input, or any combination of these actions.

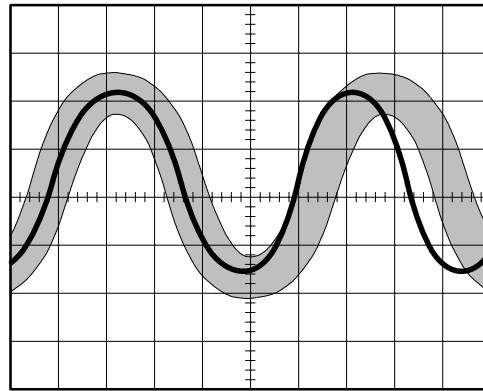

Figure 3-39: Comparing a Waveform to a Limit Template

When you use the limit testing feature, the first task is to create the limit test template from a waveform. Next, specify the channel to compare to the template. Then you specify the action to take if incoming waveform data exceeds the set limits. Finally, turn limit testing on so that the parameters you have specified will take effect.

Operation

To access limit testing:

Press **SHIFT ACQUIRE MENU** to bring up the Acquire menu.

Create Limit Test Template

To use an incoming or stored waveform to create the limit test template, first select a source.

1. Press **Create Limit Test Template** (main) → **Template Source** (side) → **Ch1, Ch2, Math1, Math2, Math3, Ref1, Ref2, Ref3, or Ref4** (side). (See Figure 3-40).

NOTE

The template will be smoother if you acquire the template waveform using **Average** acquisition mode. If you are unsure how to do this, see Acquisition Modes on page 3-5.

Once you have selected a source, select a destination for the template.

2. Press **Template Destination** (side) → **Ref1**, **Ref2**, **Ref3**, or **Ref4**.

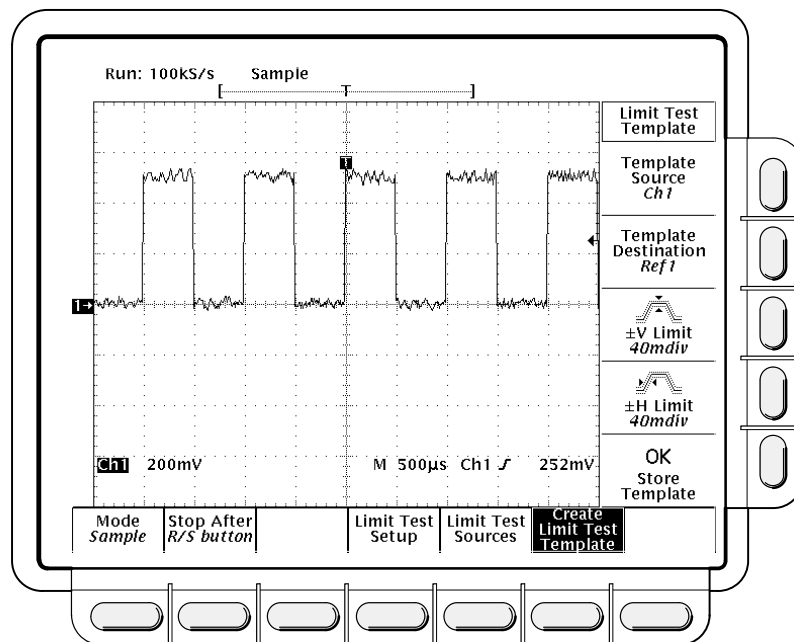

Figure 3-40: Acquire Menu — Create Limit Test Template

Now create the envelope by specifying the amount of variation from the template that you will tolerate. Tolerance values are expressed in fractions of a major division. They represent the amount by which incoming waveform data can deviate without having exceeded the limits set in the limit test. The range is from 0 (the incoming waveform must be exactly like the template source) to 5 major divisions of tolerance.

3. Press **±V Limit** (side). Enter the vertical (voltage) tolerance value using the general purpose knob or keypad.
4. Press **±H Limit** (side). Enter the horizontal (time) tolerance value using the general purpose knob or keypad.
5. When you have specified the limit test template as you wish, press **OK Store Template** (side). This action stores the specified waveform in the specified destination, using the specified tolerances. Until you have done so, the template waveform has been defined but not created.

If you wish to create another limit test template, store it in another destination to avoid overwriting the template you have just created.

If you wish to view the template you have created, press the **MORE** button. Then press the button corresponding to the destination reference memory you have used. The waveform appears on the display.

NOTE

*To view the waveform data as well as the template envelope, it might be useful to select the **Dots** display style (see Display Modes on page 3-26).*

Limit Test Sources

Now specify the channel that will acquire the waveforms to be compared against the template you have created.

1. Press **SHIFT ACQUIRE MENU** → **Limit Test Sources** (main) → **Compare Ch1 to, Compare Ch2 to, Compare Ch3 to, Compare Ch4 to, Compare Math1 to, Compare Math2 to** or **Compare Math3 to** (side).
2. Once you have selected one of the four channels or a math waveform as a waveform source from the side menu, press the same side menu button to select one of the reference memories in which you have stored a template.

Valid selections are any of the four reference waveforms **Ref1** through **Ref4** or **None**. Choosing **None** turns limit testing off for the specified channel.

NOTE

Specify the same reference memory you chose as the template destination if you wish to use the template you just created.

If you have created more than one template, you can compare one channel to one template and the other channel to another template.

Limit Test Setup

Now specify the action to take if waveform data exceeds the limits set by the limit test template.

1. Press **SHIFT ACQUIRE MENU** → **Limit Test Setup** (main) to bring up a side menu of possible actions.
2. Ensure that the side button corresponding to the desired action reads **ON**.

- If you want to send a hardcopy command when waveform data exceeds the limits set, toggle **Hardcopy if Condition Met** (side) to **ON**. You can set the hardcopy system to send the hardcopy to the file system (optional on the TDS 620A & TDS 640A). (Do not forget to set up the hardcopy system. See *Hardcopy* on page 3-57 for details.)
- If you want the bell to ring when waveform data exceeds the limits set, toggle **Ring Bell if Condition Met** (side) to **ON**.
- If you want the digitizing oscilloscope to stop when waveform data exceeds the limits set, toggle **Stop After Limit Test Condition Met** (side) to **ON**.

NOTE

*The button labeled **Stop After Limit Test Condition Met** corresponds to the **Limit Test Condition Met** menu item in the **Stop After** main menu. You can turn this button on in the **Limit Test Setup** menu, but you cannot turn it off. In order to turn it off, press **Stop After** and specify one of the other choices in the **Stop After** side menu.*

Now that you have set up the instrument for limit testing, you must turn limit testing on in order for any of these actions to take effect.

3. Ensure that **Limit Test** (side) reads **ON**. If it reads **OFF**, press **Limit Test** (side) once to toggle it to **ON**.

When you set **Limit Test** to **ON**, the digitizing oscilloscope compares incoming waveforms against the waveform template stored in reference memory according to the settings in the **Limit Test Sources** side menu.

Single and Multiple Waveforms

You can compare a single waveform against a single template, more than one waveform against a single template, or more than one waveform with each one compared against its own template. How Limit Test operates depends on which type of these comparisons you choose.

Single Waveform Comparisons

When making a single waveform versus a single template comparison, consider the following operating characteristics:

- The waveform will be repositioned horizontally to move the first sample in the waveform record that is outside of template limits to center screen.
- The position of the waveform template will track that of the waveform.

Multiple Waveform Comparisons

When comparing one or more waveforms, each against a common template or against its own template, consider the following operating characteristics:

- You should set **Horizontal Lock** to **None** in the Zoom side menu (push **ZOOM** and press (repeatedly) **Horizontal Lock** to **None**).
- With horizontal lock set as just described, the oscilloscope will reposition each waveform horizontally to move the first sample in the waveform record that is outside of template limits to center screen.
- If you are comparing each waveform to its own template, the position of each waveform template will track that of its waveform.
- If you are comparing two or more waveforms to a common template, that template will track the position of the failed waveform. If more than one waveform fails *during the same acquisition*, the template will track the position of the waveform in the highest numbered channel. For example, CH 2 is higher than CH 1.

For More Information

See *Acquisition*, on page 2-19.

See *Acquisition Modes*, on page 3-3.

See *Display Modes*, on page 3-26.

See *Zoom*, on page 3-151.

Logic Triggering

There are two classes of logic triggering: pattern and state.

A *pattern* trigger occurs when the logic inputs to the logic function you select cause the function to become TRUE (or at your option FALSE). When you use a pattern trigger, you define:

- The precondition for each logic input — logic high, low, or do not care (the logic inputs are channels 1, 2, 3, and 4 for the TDS 640A & TDS 644A and 1, 2, Aux 1, and Aux 2 for the TDS 620A)
- The Boolean logic function — select from AND, NAND, OR, and NOR
- The condition for triggering — whether the trigger occurs when the Boolean function becomes TRUE (logic high) or FALSE (logic low), and whether the TRUE condition is time qualified (see page 3-80).

A *state* trigger occurs when the logic inputs to the logic function cause the function to be TRUE (or at your option FALSE) *at the time* the clock input changes state. When you use a state trigger, you define:

- The precondition for each logic input, channels 1, 2, and 3 for the TDS 640A & TDS 644A (1, 2, and Ax1 on the TDS 620A)
- The direction of the state change for the clock input, channel 4 (Aux 2 for the TDS 620A)
- The Boolean logic function — select from clocked AND, NAND, OR, and NOR
- The condition for triggering — whether the trigger occurs when the Boolean function becomes TRUE (logic high) or FALSE (logic low)

Table 3-3 on page 3-77 lists the preconditions required for each logic function to issue a pattern or state logic trigger.

Logic Trigger Readouts

At the bottom of the display, the Trigger readout shows some of the key parameters of the logic trigger (see Figure 3-41).

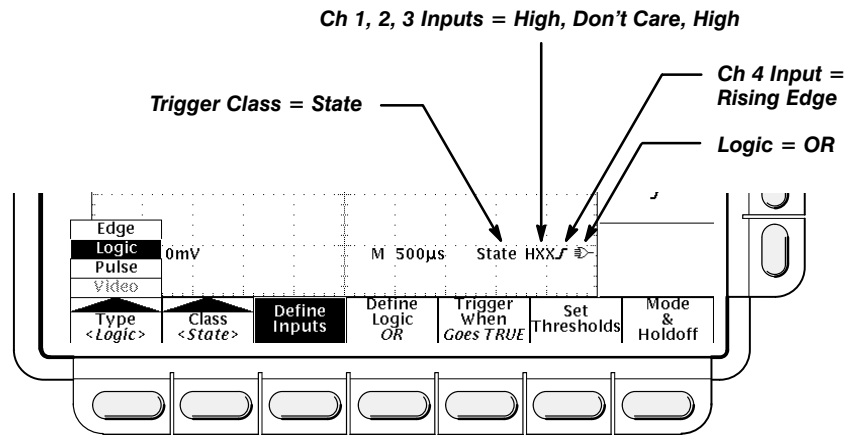

Figure 3-41: Logic Trigger Readouts

NOTE

When **Logic** is the selected trigger type, the threshold levels that help determine triggering are set for each channel individually in the **Set Thresholds** menu. Therefore, the **Trigger Level** readout will disappear on the display and the **Trigger Level** knob can be used to set the threshold level while the Main Trigger menu is set to **Logic**.









Definitions

Table 3-3 lists the definitions for the four types of logic functions available. Keep in mind the following operating modes for the two classes, pattern and state, of logic triggers as you apply the definitions.

Pattern — At the end of trigger holdoff, the oscilloscope samples the inputs from all the channels. The oscilloscope then triggers if the conditions defined in Table 3-3 are met. (**Goes TRUE** or **Goes FALSE** must be set in the **Trigger When** menu. The other settings in that menu are described in *Define a Time Qualified Pattern Trigger* on page 3-80.)

State — At the end of trigger holdoff, the oscilloscope waits until the edge of channel 4 (Aux 2 on the TDS 620A) transitions in the specified direction. At that point, the oscilloscope samples the inputs from the other channels and triggers if the conditions defined in Table 3-3 are met.

Table 3-3: Logic Triggers

Pattern	State	Definition ^{1,2}
 AND	 Clocked AND	If <i>all</i> the preconditions selected for the logic inputs ³ are true, then the oscilloscope triggers.
 NAND	 Clocked NAND	If <i>not all</i> of the preconditions selected for the logic inputs ³ are true, then the oscilloscope triggers.
 OR	 Clocked OR	If <i>any</i> of the preconditions selected for the logic inputs ³ are true, then the oscilloscope triggers.
 NOR	 Clocked NOR	If <i>none</i> of the preconditions selected for the logic inputs ³ are true, then the oscilloscope triggers.

¹Note that for State class triggers, the definition must be met at the time the clock input changes state. See the descriptions for Pattern and State in this section.

²The definitions given here are correct for the Goes True setting in the Trigger When menu. If that menu is set to Goes False, swap the definition for AND with that for NAND and for OR with NOR for both pattern and state classes.

³The logic inputs are channels 1, 2, 3, and 4 for the TDS 640A & TDS 644A and 1, 2, Aux 1 and Aux 2 for the TDS 620A when using Pattern Logic Triggers. For State Logic Triggers, channel 4 (Aux 2 for the TDS 620A) becomes the clock input, leaving the remaining channels as logic inputs.

Operations Common to Pattern and State

The Logic Trigger menu (Figure 3-42) lets you select when to trigger (true or false), set the thresholds for each channel, select the mode (auto or normal), and adjust the holdoff.

Press **TRIGGER MENU** → **Type** (main) → **Logic** (pop-up) → **Class** (main) → **Pattern** or **State** (pop-up).

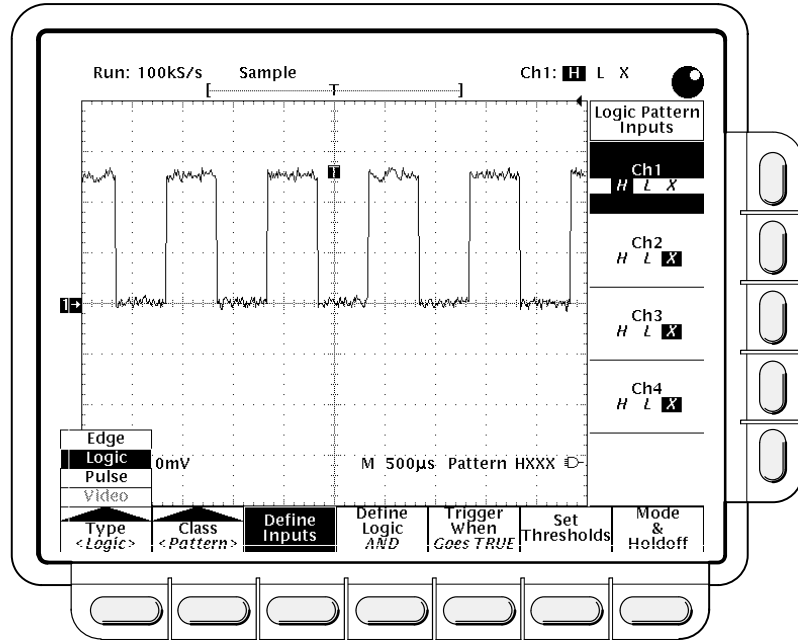

Figure 3-42: Logic Trigger Menu

Trigger When

This menu item lets you determine if the oscilloscope will trigger when the logic condition is met (**Goes TRUE**) or when the logic condition is not met (**Goes FALSE**). (The **True when less than** and **True when greater than** menu items are only used for pattern logic triggering and are covered on page 3-80.)

Press **TRIGGER MENU** → **Type** (main) → **Logic** (pop-up) → **Class** (main) → **Pattern** or **State** (pop-up) → **Trigger When** (main) → **Goes TRUE** or **Goes FALSE** (side).

Set Thresholds

To set the logic threshold for each channel:

1. Press **TRIGGER MENU** → **Type** (main) → **Logic** (pop-up) → **Class** (main) → **Pattern** or **State** (pop-up) → **Set Thresholds** (main) → **Ch1**, **Ch2**, **Ch3** (**Ax1** on the TDS 620A), or **Ch4** (**Ax2** on the TDS 620A) (side).
2. Use the **MAIN TRIGGER LEVEL** knob, the general purpose knob, or the keypad to set each threshold.

Mode & Holdoff

You can change the holdoff time and select the trigger mode using this menu item.

1. Press **TRIGGER MENU** → **Type** (main) → **Logic** (pop-up) → **Class** (main) → **Pattern** or **State** (pop-up) → **Mode & Holdoff** (main) → **Auto** or **Normal** (side).
 - In **Auto** mode the oscilloscope acquires a waveform after a specific time has elapsed even if a trigger does not occur. The amount of time the oscilloscope waits depends on the time base setting.
 - In **Normal** mode the oscilloscope acquires a waveform only if there is a valid trigger.
2. Press **Holdoff** (side). Enter the value in percent using the general purpose knob or the keypad.

Depending on whether you chose the class **Pattern** or **State**, there are different menus for defining the channel inputs and the combinational logic.

Pattern Operations

When you select **Pattern**, the oscilloscope will trigger on a specified logic combination of the four input channels. See page 3-77 for details on operations common to both pattern and state triggers.

Define Inputs

To set the logic state for each of the input channels (**Ch1**, **Ch2**, ...):

1. Press **TRIGGER MENU** → **Type** (main) → **Logic** (pop-up) → **Class** (main) → **Pattern** (pop-up) → **Define Inputs** (main) → **Ch1**, **Ch2**, **Ch3**, or **Ch4** (side). (On the TDS 620A, **Ch3** and **Ch4** are replaced by **Ax1** and **Ax2**.)
2. Repeatedly press each input selected in step 1 to choose either High (**H**), Low (**L**), or Don't Care (**X**) for each channel.

Define Logic

To choose the logic function you want applied to the input channels (see page 3-76 for definitions of the logic functions for both pattern and state triggers):

Press **TRIGGER MENU** → **Type** (main) → **Logic** (pop-up) → **Class** (main) → **Pattern** (pop-up) → **Define Logic** (main) → **AND**, **OR**, **NAND**, or **NOR** (side).

Define a Time Qualified Pattern Trigger

You can also time qualify a pattern logic trigger. That is, you specify a time that the boolean logic function (AND, NAND, OR, or NOR) must be TRUE (logic high). You also choose the type of time qualification (greater or less than the time limit specified) as well as the time limit using the Trigger When menu selection.

1. Press **TRIGGER MENU** → **Type** (main) → **Logic** (pop-up) → **Class** (main) → **Pattern** (pop-up) → **Trigger When** (main) → **True for less than** or **True for more than** (side).
2. Use the knob and keypad to set the time in the side menu.

When you select **True for less than** and specify a time using the general purpose knob, the input conditions you specify must drive the logic function high (TRUE) for less than the time you specify. Conversely, **True for more than** requires the boolean function to be TRUE for longer than the time you specify.

Note the position of the trigger indicator in Figure 3-43. Triggering occurs at the point the logic function you specify is determined to be true within the time you specify. The digitizing oscilloscope determines the trigger point in the following manner:

- It waits for the logic condition to become true
- It starts timing and waits for the logic function to become false
- It compares the times and, if the time TRUE is longer (for **True for more than**) or shorter (for **True for less than**), then it triggers a waveform display *at the point the logic condition became false*. This time can be, and usually is, different from the time set for **True for more than** or **True for less than**.

In Figure 3-43, the delay between the vertical bar cursors is the time the logic function is TRUE. Since this time is more (216 μ s) than that set in the **True for more than** menu item (150 μ s), the oscilloscope issues the trigger at that point, not at the point at which it has been true for 216 μ s.

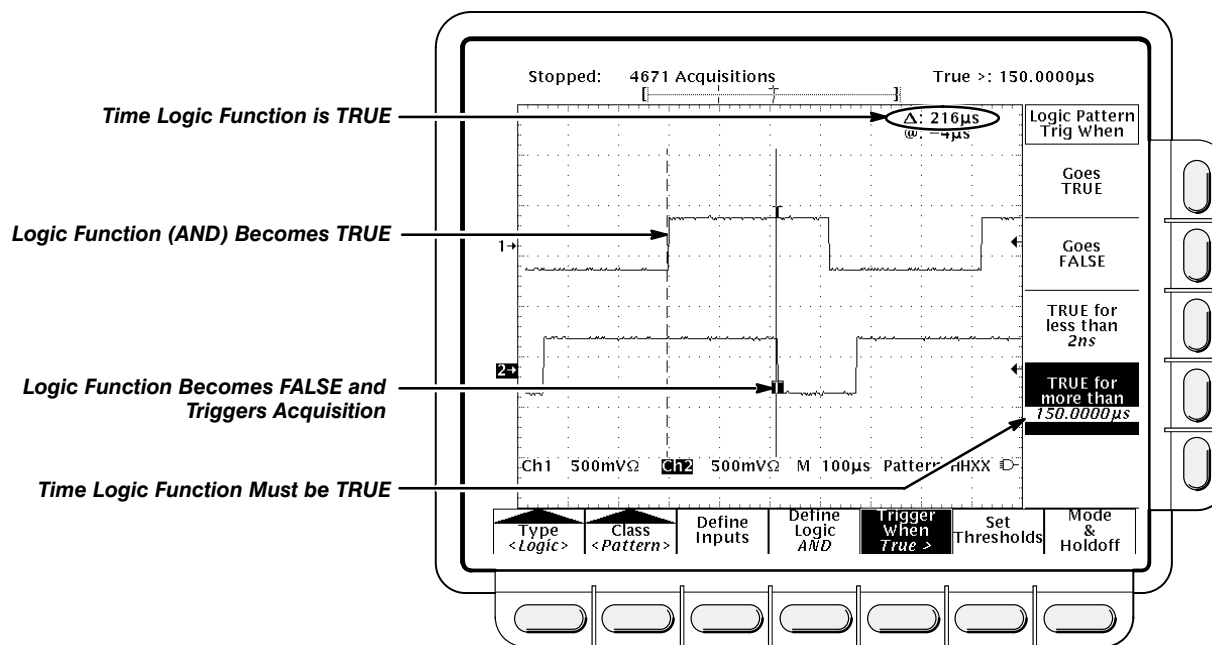

Figure 3-43: Logic Trigger Menu — Time Qualified TRUE

State Operations

When you select **State** logic triggering, the oscilloscope uses channel 4 (Aux 2 on the TDS 620A) as a clock for a logic circuit made from the rest of the channels. See page 3-77 for details on operations common to both pattern and state triggers.

The state trigger logic works as follows: the oscilloscope waits until the fourth channel meets the selected slope and voltage threshold. It then checks the logic function applied to the first three channels, and if the function condition is as specified in the the **Trigger When** menu (**Goes TRUE** or **Goes FALSE**) a trigger occurs.

Define Inputs

To set the logic state for each of the input channels (**Ch1**, **Ch2**, ...):

1. Press **TRIGGER MENU** → **Type** (main) → **Logic** (pop-up) → **Class** (main) → **State** (pop-up) → **Define Inputs** (main).
2. Choose either High (**H**), Low (**L**), or Don't Care (**X**) (side) for the first three channels. The choices for **Ch4** (**Aux 2** on the TDS 620A) are rising edge and falling edge.

Define Logic

To choose the type of logic function you want applied to the input channels:

Press **TRIGGER MENU** → **Type** (main) → **Logic** (pop-up) → **Class** (main) → **State** (pop-up) → **Define Logic** (main) → **AND, OR, NAND, or NOR** (side).

For More Information

See *Triggering*, on page 2-13.

See *Triggering*, on page 3-132.

Measurement System

There are various ways to measure properties of waveforms. You can use graticule, cursor, or automatic measurements. This section describes *automatic measurements*; cursors and graticules are described elsewhere. (See *Cursor Measurements* on page 3-15 and *Measurements* on page 2-26.)

Automatic measurements are generally more accurate and quicker than, for example, manually counting graticule divisions. The oscilloscope will continuously update and display these measurements. (There is also a way to display all the measurements at once — see *Snapshot of Measurements* on page 3-92.)

Automatic measurements calculate waveform parameters from acquired data. Measurements are performed over the entire waveform record or the region specified by the vertical cursors, if gated measurements have been requested. (See page 3-88 for a discussion of gated measurements.) They are not performed just on the displayed portions of waveforms.

The TDS 600A Digitizing Oscilloscope provides you with 25 automatic measurements (see Table 3-4).

Definitions

The following are brief definitions of the automated measurements in the digitizing oscilloscope (for more details see *Appendix C: Algorithms*, page A-7).

Table 3-4: Measurement Definitions







Name	Definition
 Amplitude	Voltage measurement. The high value less the low value measured over the entire waveform or gated region. $\text{Amplitude} = \text{High} - \text{Low}$
 Area	Voltage over time measurement. The area over the entire waveform or gated region in volt-seconds. Area measured above ground is positive; area below ground is negative.
 Cycle Area	Voltage over time measurement. The area over the first cycle in the waveform, or the first cycle in the gated region, in volt-seconds. Area measured above ground is positive; area below ground is negative.
 Burst Width	Timing measurement. The duration of a burst. Measured over the entire waveform or gated region.
 Cycle Mean	Voltage measurement. The arithmetic mean over the first cycle in the waveform or the first cycle in the gated region.
 Cycle RMS	Voltage measurement. The true Root Mean Square voltage over the first cycle in the waveform or the first cycle in the gated region.

Table 3-4: Measurement Definitions (Cont.)



















Name	Definition
 Delay	Timing measurement. The time between the MidRef crossings of two different traces or the gated region of the traces.
 Fall Time	Timing measurement. Time taken for the falling edge of the first pulse in the waveform or gated region to fall from a High Ref value (default = 90%) to a Low Ref value (default = 10%) of its final value.
 Frequency	Timing measurement for the first cycle in the waveform or gated region. The reciprocal of the period. Measured in Hertz (Hz) where 1 Hz = 1 cycle per second.
 High	The value used as 100% whenever High Ref, Mid Ref, and Low Ref values are needed (as in fall time and rise time measurements). Calculated using either the min/max or the histogram method. The <i>min/max</i> method uses the maximum value found. The <i>histogram</i> method uses the most common value found above the mid point. Measured over the entire waveform or gated region.
 Low	The value used as 0% whenever High Ref, Mid Ref, and Low Ref values are needed (as in fall time and rise time measurements). May be calculated using either the min/max or the histogram method. With the min/max method it is the minimum value found. With the histogram method, it refers to the most common value found below the mid point. Measured over the entire waveform or gated region.
 Maximum	Voltage measurement. The maximum amplitude. Typically the most positive peak voltage. Measured over the entire waveform or gated region.
 Mean	Voltage measurement. The arithmetic mean over the entire waveform or gated region.
 Minimum	Voltage measurement. The minimum amplitude. Typically the most negative peak voltage. Measured over the entire waveform or gated region.
 Negative Duty Cycle	Timing measurement of the first cycle in the waveform or gated region. The ratio of the negative pulse width to the signal period expressed as a percentage. $NegativeDutyCycle = \frac{NegativeWidth}{Period} \times 100\%$
 Negative Over-shoot	Voltage measurement. Measured over the entire waveform or gated region. $NegativeOvershoot = \frac{Low - Min}{Amplitude} \times 100\%$
 Negative Width	Timing measurement of the first pulse in the waveform or gated region. The distance (time) between MidRef (default 50%) amplitude points of a negative pulse.
 Peak to Peak	Voltage measurement. The absolute difference between the maximum and minimum amplitude in the entire waveform or gated region.
 Phase	Timing measurement. The amount one waveform leads or lags another in time. Expressed in degrees, where 360° comprise one waveform cycle.

Table 3-4: Measurement Definitions (Cont.)

Name	Definition
 Period	Timing measurement. Time it takes for the first complete signal cycle to happen in the waveform or gated region. The reciprocal of frequency. Measured in seconds.
 Positive Duty Cycle	Timing measurement of the first cycle in the waveform or gated region. The ratio of the positive pulse width to the signal period expressed as a percentage. $PositiveDutyCycle = \frac{PositiveWidth}{Period} \times 100\%$
 Positive Overshoot	Voltage measurement over the entire waveform or gated region. $PositiveOvershoot = \frac{Max - High}{Amplitude} \times 100\%$
 Positive Width	Timing measurement of the first pulse in the waveform or gated region. The distance (time) between MidRef (default 50%) amplitude points of a positive pulse.
 Rise time	Timing measurement. Time taken for the leading edge of the first pulse in the waveform or gated region to rise from a Low Ref value (default = 10%) to a High Ref value (default = 90%) of its final value.
 RMS	Voltage measurement. The true Root Mean Square voltage over the entire waveform or gated region.

Measurement Display

The readout area for measurements is on the right side of the waveform window. You can display and continuously update as many as four measurements at any one time. When menus are displayed, the readouts appear in the graticule area. If the menu area is empty, then the readouts are displayed to the far right (see Figure 3-44).

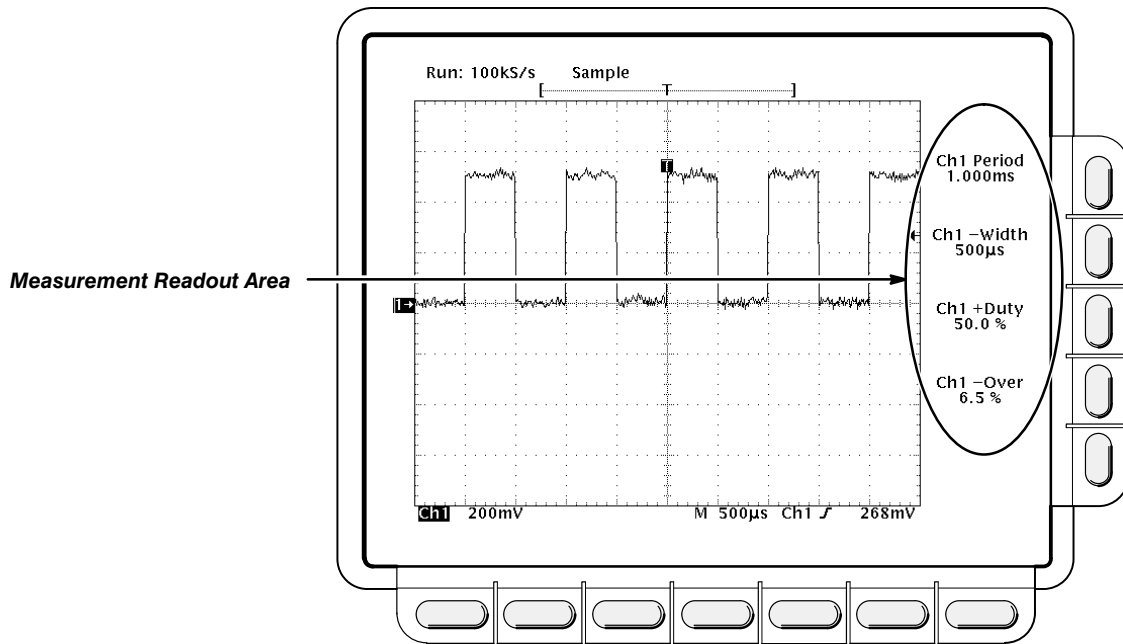

Figure 3-44: Measurement Readouts

Operation

To use the automatic measurements you first need to obtain a stable display of the waveform to be measured. Pressing **AUTOSET** may help. Once you have a stable display, press **MEASURE** to bring up the Measure menu (see Figure 3-45).

Selecting a Measurement

Measurements are made on the selected waveform. The measurement display tells you the channel the measurement is being made on.

1. Press **MEASURE** → **Select Measmnt** (main).
2. Select a measurement from the side menu.

The following are hints on making automatic measurements:

- You can only take a maximum of four measurements at a time. To add a fifth, you must remove one or more of the existing measurements.

- To vary the source for measurements, simply select the other channel and then choose the measurements you want.
- Be careful when taking automatic measurements on noisy signals. You might measure the frequency of the noise and not the desired waveform.

Your digitizing oscilloscope helps identify such situations by displaying a *low signal amplitude* or *low resolution* warning message.

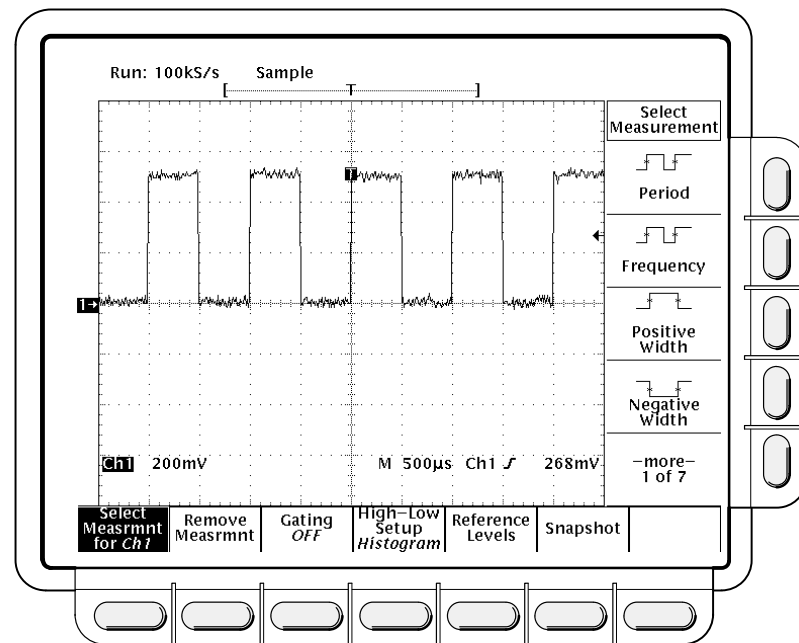

Figure 3-45: Measure Menu

Removing Measurements

The **Remove Measrmt** selection provides explicit choices for removing measurements from the display according to their readout position.

Measurement 1 is the top readout. Measurement 2 is below it, and so forth. Once a measurement readout is displayed in the screen area, it stays in its position even when you remove any measurement readouts above it. To remove measurements:

1. Press **MEASURE** → **Remove Measrmt** (main).
2. Select the measurement to remove from the side menu. If you want to remove all the measurements at one time, press **All Measurements** (side).

Gated Measurements

The gating feature lets you limit measurements to a specified portion of the waveform. When gating is **Off**, the oscilloscope makes measurements over the entire waveform record.

When gating is activated, vertical cursors are displayed. Use these cursors to define the section of the waveform you want the oscilloscope to measure. This is called the *gated region*.

1. Press **MEASURE** → **Gating** (main) → **Gate with V Bar Cursors** (side) (see Figure 3-46).

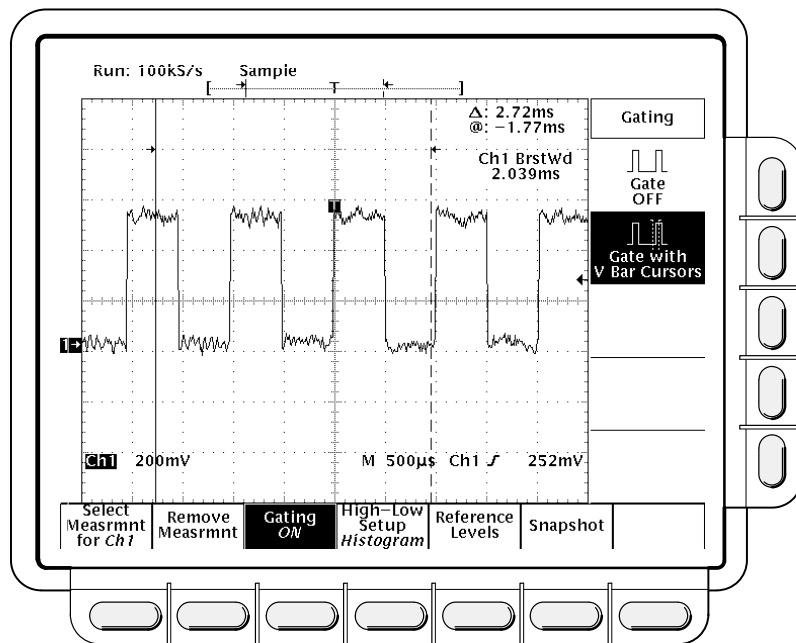

Figure 3-46: Measure Menu — Gating

2. Using the general purpose knob, move the selected (the active) cursor. Press **SELECT** to change which cursor is active.

Displaying the cursor menu and turning V Bar cursors off will *not* turn gating off. (Gating arrows remain on screen to indicate the area over which the measurement is gated.) You must turn gating off in the Gating side menu.

NOTE

Cursors are displayed relative to the selected waveform. If you are making a measurement using two waveforms, this can be a source of confusion. If you turn off horizontal locking and adjust the horizontal position of one waveform independent of the other, the cursors appear at the requested position with respect to the selected waveform. Gated measurements remain accurate, but the displayed positions of the cursors change when you change the selected waveform.

High-Low Setup

The **High-Low Setup** item provides two choices for how the oscilloscope determines the High and Low levels of waveforms. These are *histogram* and *min-max*.

- Histogram sets the values statistically. It selects the most common value either above or below the mid point (depending on whether it is defining the high or low reference level). Since this statistical approach ignores short term aberrations (overshoot, ringing, etc.), histogram is the best setting for examining pulses.
- Min-max uses the highest and lowest values of the waveform record. This setting is best for examining waveforms that have no large, flat portions at a common value, such as sine waves and triangle waves — almost any waveform except for pulses.

To use the high-low setup:

Press **MEASURE** → **High-Low Setup** (main) → **Histogram** or **Min-Max** (side). If you select **Min-Max**, you may also want to check and/or revise values using the Reference Levels main menu.

Reference Levels

Once you define the reference levels, the digitizing oscilloscope will use them for all measurements requiring those levels. To set the reference levels:

1. Press **MEASURE** → **Reference Levels** (main) → **Set Levels** (side) to choose whether the References are set in % relative to High (100%) and Low (0%) or set explicitly in the units of the selected waveform (typically volts). See Figure 3-47. Use the general purpose knob or keypad to enter the values.
 - % is the default selection. It is useful for general purpose applications.
 - **Units** is helpful for setting precise values. For example, if you are trying to measure specifications on an RS-232-C circuit, you can set the levels precisely to RS-232-C specification voltage values by defining the high and low references in units.

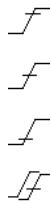

2. Press **High Ref**, **Mid Ref**, **Low Ref**, or **Mid2 Ref** (side).
 - **High Ref** — Sets the high reference level. The default is 90%.
 - **Mid Ref** — Sets the middle reference level. The default is 50%.
 - **Low Ref** — Sets the low reference level. The default is 10%.
 - **Mid2 Ref** — Sets the middle reference level used on the second waveform specified in the Delay or Phase Measurements. The default is 50%.

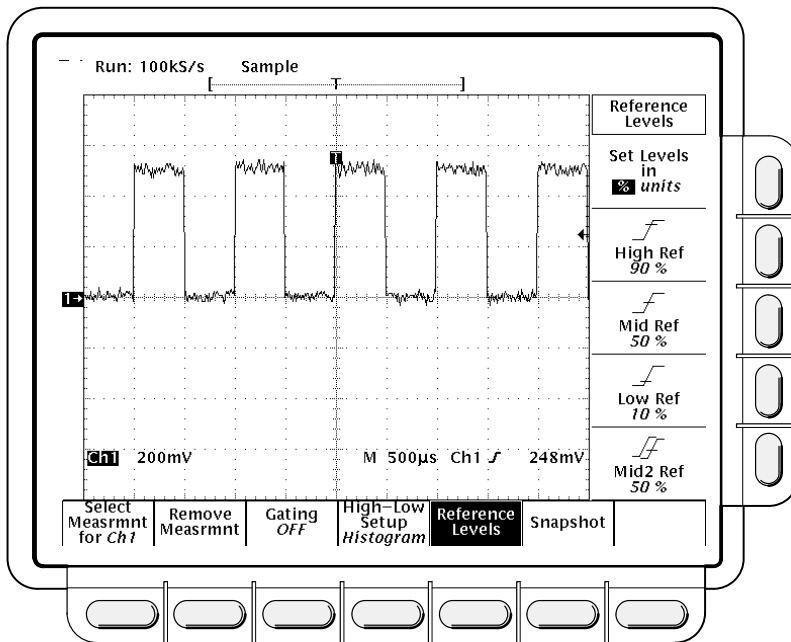

Figure 3-47: Measure Menu — Reference Levels

Delay Measurement

The delay measurement lets you measure from an edge on the selected waveform to an edge on another waveform. You access the Delay Measurement menu through the Measure main menu:

Press **MEASURE** → **Select Measrmt** (main) → **Delay** (side). This brings up the Measure Delay main menu (see Figure 3-48).

Delay to — To select the waveform you want to measure *to*, use the main menu item **Delay to**. The waveform you are measuring *from* is the selected waveform.

1. Press **MEASURE** → **Select Measrmt** (main) → **Delay** (side) → **Delay To** (main) → **Measure Delay to**.

- Press **Measure Delay to** (side) repeatedly to choose the delay *to* waveform. The choices are **Ch1, Ch2, Ch3, Ch4** (on the TDS 644A & TDS 640A); **Ch1, Ch2, Ax1, Ax2** (on the TDS 620A); and **Math1, Math2, Math3, Ref1, Ref2, Ref3, and Ref4**.

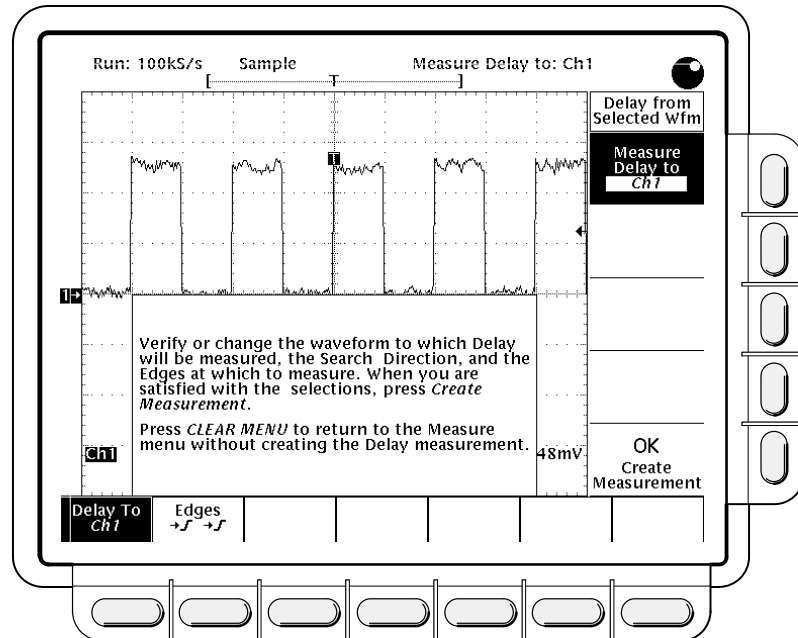

Figure 3-48: Measure Delay Menu — Delay To

Delay Edges — The main menu item **Edges** lets you specify which edges you want the delayed measurement to be made between.

Press **MEASURE** → **Select Measmnt** (main) → **Delay** (side) → **Edges** (main). A side menu of delay edges and directions will appear. Choose from one of the combinations displayed on the side menu.

The upper waveform on each icon represents the *from* waveform and the lower one represents the *to* waveform.

The direction arrows on the choices let you specify a forward search on both waveforms or a forward search on the *from* waveform and a backwards search on the *to* waveform. The latter choice is useful for isolating a specific pair of edges out of a stream.

Creating the Delay Measurement — Once you have specified the waveforms you are measuring between and which edges to use, you need to notify the digitizing oscilloscope to proceed with the measurement.

Press **Delay To** (main) → **OK Create Measurement** (side).

To exit the Measure Delay menu without creating a delay measurement, press **CLEAR MENU**, which returns you to the Measure menu.

Snapshot of Measurements

Sometimes you may want to see all of the automated measurements on screen at the same time. To do so, use Snapshot. Snapshot executes all of the single waveform measurements available on the selected waveform *once* and displays the results. (The measurements are not continuously updated.) All of the measurements listed in Table 3-4 on page 3-83 except for Delay and Phase are displayed. (Delay and Phase are dual waveform measurements and are not available with Snapshot.)

The readout area for a snapshot of measurements is a pop up display that covers about 80% of the graticule area when displayed (see Figure 3-49). You can display a snapshot on any channel or ref memory, but only one snapshot can be displayed at a time.

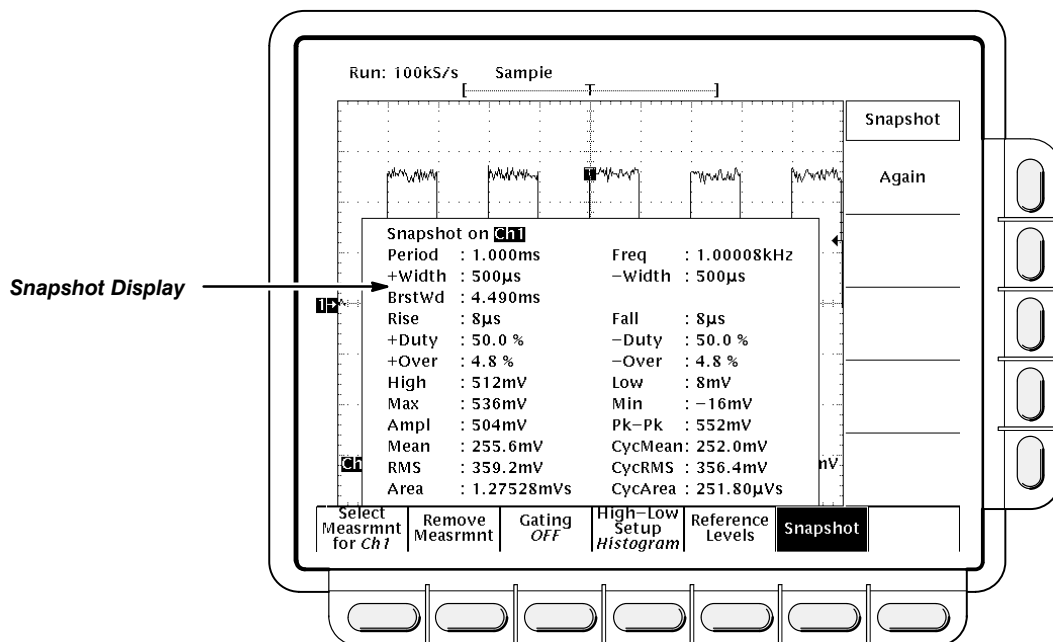

Figure 3-49: Snapshot Menu and Readout

To use snapshot, obtain a stable display of the waveform to be measured. Pressing **AUTOSET** may help.

1. Press **MEASURE** → **SNAPSHOT** (main).
2. Press either **SNAPSHOT** (main) or **AGAIN** (side) to take another snapshot.

NOTE

The snapshot display tells you the channel that the snapshot is being made on.

3. Push **Remove Measrmt**.

Considerations When Taking Snapshots

Be aware of the following items when using snapshot:

- Be sure to display the waveform properly before taking a snapshot. Snapshot does not warn you if a waveform is improperly scaled (clipped, low signal amplitude, low resolution, etc.).
- To vary the source for taking a snapshot, simply select another channel, math, or ref memory waveform and then execute snapshot again.
- A snapshot is taken on a single waveform acquisition (or acquisition sequence). The measurements in the snapshot display are not continuously updated.
- Be careful when taking automatic measurements on noisy signals. You might measure the frequency of the noise and not the desired waveform.
- Note that pushing any button in the main menu (except for Snapshot) or any front panel button that displays a new menu removes the snapshot from display.
- Use High-Low Setup (page 3-89), Reference Levels (page 3-89), and Gated Measurements (page 3-88) with snapshot exactly as you would when you display individual measurements from the **Select Measrmt** menu.

For More Information

See *Appendix B: Algorithms*, on page A-7.

See *Measurements*, on page 2-26.

See *Tutorial Example 3: Automated Measurements*, on page 1-18.

Probe Cal

This oscilloscope lets you compensate the entire signal path, from probe tip to digitized signal, to improve the gain and offset accuracy of the probe. By executing *Probe Cal* on a channel with its probe installed, you can optimize the oscilloscope capability to make accurate measurements using that channel and probe.

Run a Probe Cal anytime you wish to ensure that the measurements you make are made with the most accuracy possible. You should also run a Probe Cal if you have changed to a different probe since the last Probe Cal was performed.

Probe Cal vs. Probe Type

Some types of probes can be gain compensated, some can be offset compensated, and some can be compensated for both. *Some probes cannot be compensated.*

If your probe has an attenuation factor of greater than 20X, it cannot be compensated. If you attempt to compensate such a probe you will get an error message.

The digitizing oscilloscope cannot compensate probes whose gain and/or offset errors are too great ($> 2\%$ gain and/or > 50 mV offset). If these errors are within specified limits for your probe, you may wish to use another probe. If they are not within specification, have your probe checked by service personnel.

Operation

If you are installing an *active* probe, such as the P6205, there are no prerequisites to performing this procedure. Start at step 1.

If you are compensating for a *passive* probe with this procedure you must first compensate the low frequency response of the probe. First, do steps 1 and 2 below, and then perform the instructions found under *Probe Compensation* on page 3-100. Then continue with step 3 of this procedure.

1. Install the probe on the input channel on which it is to be used.
2. Power on the digitizing oscilloscope and allow a 20 minute warm-up before doing this procedure.
3. Press **SHIFT UTILITY** → **System** (main) → **Cal** (pop-up).
4. Look at the status label under **Signal Path** in the main menu. If the status does not read **Pass**, perform a signal path compensation (*Signal Path Compensation*, page 3-128), and then continue with this procedure.
5. Press the front-panel button corresponding to the input channel on which you installed the probe.

6. Press **VERTICAL MENU** → **Cal Probe** (main).



Your oscilloscope will detect the type of probe you have installed and display screen messages and menu choices for compensation of probe gain, offset, or both (see Figure 3-50). The following steps will have you run probe gain, offset, or both depending on the probe the oscilloscope detects.

7. If the message on screen is *Probe Offset Compensation* rather than *Probe Gain Compensation*, skip to step 15.
8. Connect the probe tip to **PROBE COMPENSATION SIGNAL**; connect the probe ground lead to **PROBE COMPENSATION GND**.
9. Press **OK Compensate Gain** (side).
10. Wait for gain compensation to complete (one to three minutes).



When gain compensation completes, the following actions occur:

- The clock icon will disappear.
- If offset compensation is required for the probe installed, the *Probe Offset Compensation* message will replace the *Probe Gain Compensation* message.
- If gain compensation did not complete successfully, you may get a “Probe is not connected” message (examine the probe connections to the digitizing oscilloscope, be sure the probe tip is properly installed in its retractor, etc., and repeat step 9).
- If gain compensation did not complete successfully, you may get the message “Compensation Error.” This error implies that the probe gain (2% error) and/or offset (50 mV) is too great to be compensated. You can substitute another probe and continue. Have your probe checked by service personnel.

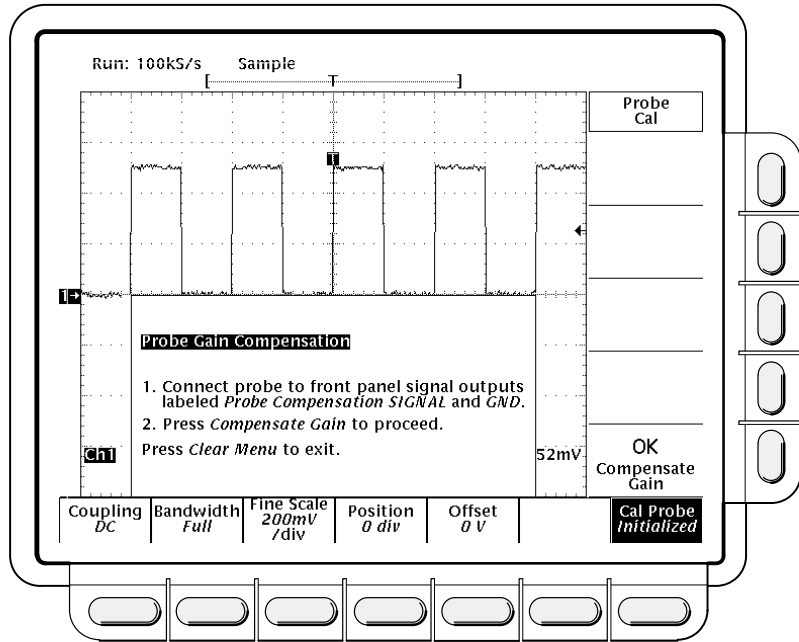

Figure 3-50: Probe Cal Menu and Gain Compensation Display

11. If the Probe *Offset* Compensation message is displayed, continue with step 15; otherwise, continue with step 12.
12. If the Compensation Error message is displayed, continue with step 13; otherwise continue with step 18.
13. Press **SHIFT UTILITY** → **System** (main) → **Diag/Err** (pop-up) → **Error Log** (main). If there are too many error messages to be seen on screen, rotate the general purpose knob clockwise to scroll to the last message.
14. Note the compensation error amount. Skip to step 19.
15. Disconnect the probe from any signal you may have connected it to. Leave the probe installed on its channel.
16. Press **OK Compensate Offset** (side).
17. Wait for offset compensation to complete (one to three minutes).



When offset compensation completes, the following occurs:

- The clock icon will disappear.
 - If offset compensation did not complete successfully, you may get the message “Compensation Error.” This error implies that the probe offset scale (10% error) and/or offset (50 mV) is too great to be compensated. You can substitute another probe and continue. Have your probe checked by service personnel. You can also check the error log by doing steps 13 through 14.
18. After the clock icon is removed, verify the word **Initialized** changed to **Pass** under **Cal Probe** in the main menu. (See Figure 3-50.)

19. If desired, repeat this procedure beginning at step 1 to compensate for other probe/channel combinations. But before you do so, be sure you take note of the following requirements:
 - Remember to first low frequency compensate any passive probe you connect (see *Prerequisites* at the beginning of this procedure).
 - Remember to connect all but simple passive probes to the oscilloscope for a twenty minute warm up before running Probe Cal.

Usage

The following topic contains information you should consider when using input channels that have stored a Probe Cal.

Changing Probes After a Probe Cal

If a Probe Cal has never been performed on an input channel or if its stored Probe Cal data is erased using the *Re-use Probe Calibration Data* menu (discussed later), the oscilloscope displays *Initialized* status in its vertical menu. It also displays initialized whenever you remove a probe from an input.

If you execute a successful Probe Cal on an input channel, the oscilloscope stores the compensation data it derived in non-volatile memory. Therefore, this data is available when you turn the oscilloscope off and back on, when you change probes, etc.

When you install a probe or power on the oscilloscope with probes installed, the oscilloscope tests the probe at each input. Depending on the probe it finds on each input, it takes one of the following actions:

- If the probe has a complex oscilloscope interface (it can convey additional information, such as a unique identification number), the oscilloscope determines whether it is the same probe for which data was stored. If it is, the oscilloscope sets status to pass; if not, it sets the status to *Initialized*.
- If a probe has a simple oscilloscope interface, the oscilloscope can usually determine if it has a different probe attenuation factor than that stored for the last Probe Cal. It can also determine if the last Probe Cal was for a probe with a complex interface. If either is the case, the probe installed is different from that stored for the last Probe Cal. Therefore, the oscilloscope sets the status to *Initialized*.
- If a probe has a simple oscilloscope interface and the probe attenuation factor is the same as was stored at the last Probe Cal, the oscilloscope cannot determine whether it is the same probe. Therefore, it displays the *Re-use Probe Calibration data?* menu (see Figure 3-51).

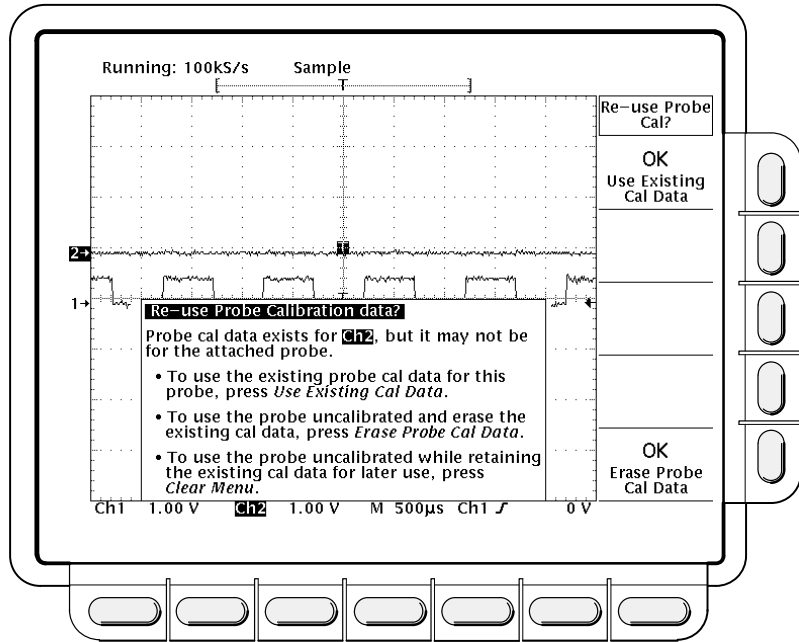

Figure 3-51: Re-use Probe Calibration Data Menu

If the *Re-use Probe Calibration data?* menu is displayed, you can choose one of the following options:

- Press **OK Use Existing Data** (side) to *use* the Probe Cal data last stored to compensate the probe.
- Press **OK Erase Probe Cal Data** (side) to *erase* the Probe Cal data last stored and use the probe uncompensated.
- Press **CLEAR MENU** on the front panel to *retain* the Probe Cal data last stored and use the probe uncompensated.

Table 3-5 shows the action the oscilloscope takes based on the probe connected and user operation performed.

Table 3-5: Probe Cal Status

Probe Cal'd? ¹	User Action	Type Probe Connected ²	
		Simple Interface ³	Complex Interface ⁴
No	Doesn't Matter	<i>Initialized</i>	<i>Initialized</i>
Yes	Power off	<i>Initialized</i> (probe data is retained)	<i>Initialized</i> (probe data is retained)
Yes	Power on	Can not detect different probe: Display <i>Re-use Probe Calibration Data</i> menu Different probe: <i>Initialized</i>	Cal'd Probe: <i>Pass</i> Different probe: <i>Initialized</i>

Table 3-5: Probe Cal Status (Cont.)

Probe Cal'd? ¹	User Action	Type Probe Connected ²	
		Simple Interface ³	Complex Interface ⁴
Yes	Disconnect Probe	<i>Initialized</i>	<i>Initialized</i>
Yes	Connect Probe	Can not detect different probe: <i>Probe Calibration Data</i> menu Different probe:	Display <i>Re-use</i> <i>Initialized</i> Cal'd Probe: <i>Pass</i> Different probe: <i>Initialized</i>

¹Refers to a channel input that was *successfully* compensated at the time Probe Cal was last executed for the input channel.

²If no probe is connected, the probe status in the vertical main menu is always *initialized*.

³A probe with a simple interface is a probe that can convey very limited information to the oscilloscope. Most passive probes (such as the standard accessory P6139A) have simple interfaces.

⁴A probe with a complex interface is a probe that can convey additional information. For instance, it might automatically set the oscilloscope input channel impedance to match the probe, send the oscilloscope a unique probe identification number, etc. Some optical probes and most active probes (including the optional P6205) have complex interfaces.

Probe Compensation

Passive probes require compensation to ensure maximum distortion-free input to the digitizing oscilloscope and to avoid high frequency amplitude errors (see Figure 3-52).

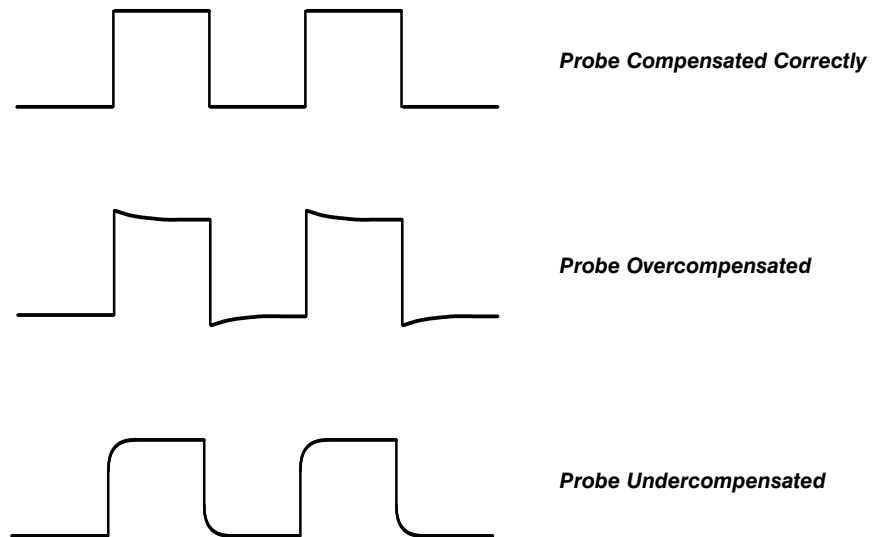

Figure 3-52: How Probe Compensation Affects Signals

Operation

To compensate your probe:

1. Connect the probe to the probe compensation signal on the front panel.
2. Press **AUTOSET**.

NOTE

When you connect an active probe to the oscilloscope (such as the P6205), the input impedance of the oscilloscope automatically becomes 50 Ω . If you then connect a high resistance passive probe (like the P6139A) you need to set the input impedance back to 1 M Ω . Step 4 explains how to change the input impedance.

You now need to limit the bandwidth and change the acquisition mode.

3. Press **VERTICAL MENU** \rightarrow **Bandwidth** (main) \rightarrow **20 MHz** (side).

4. If you need to change the input impedance, press **Coupling** (main). Then toggle the side menu selection Ω to get the correct impedance.
5. Adjust the probe until you see a perfectly flat top square wave on the display. Figure 3-53 shows where the adjustment is located.

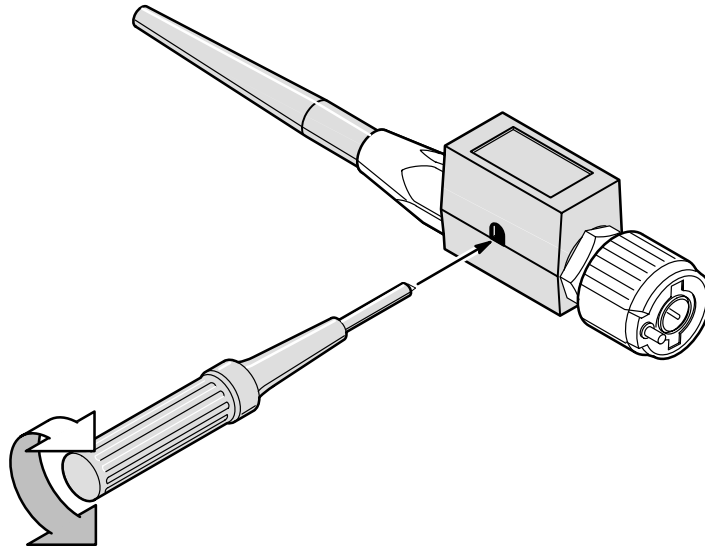

Figure 3-53: P6139A Probe Adjustment

**For More
Information**

See *Probe Selection*, on page 3-102.

Probe Selection

The probes included with your digitizing oscilloscope are useful for a wide variety of tasks. However, for special measurement situations you sometimes need different probes. This section helps you select the right probe for the job.

Once you have decided the type of probe you need, use Table 3-6 (page 3-107) to determine the specific probe compatible with your TDS 600A Digitizing Oscilloscope. Or use Table 3-7 (page 3-108) if you want to select the probe by application.

There are five major types of probes: passive, active, current, optical, and time-to-voltage probes. Most of these types are discussed here; see your Tektronix Products Catalog for more information.

Passive Voltage Probes

Passive voltage probes measure voltage. They employ passive circuit components such as resistors, capacitors, and inductors. There are three common classes of passive voltage probes:

- *General purpose (high input resistance)*
- *Low impedance (Z_O)*
- *High voltage*

General Purpose (High Input Resistance) Probes

High input resistance probes are considered “typical” oscilloscope probes. The high input resistance of passive probes (typically 10 M Ω) provides negligible DC loading and makes them a good choice for accurate DC amplitude measurements.

However, their 8 pF to 12 pF (over 60 pF for 1X) capacitive loading can distort timing and phase measurements. Use high input resistance passive probes for measurements involving:

- Device characterization (above 15 V, thermal drift applications)
- Maximum amplitude sensitivity using 1X high impedance
- Large voltage range (between 15 and 500 V)
- Qualitative or go/no-go measurements

Low Impedance (Z_O) Probes

Low impedance probes measure frequency more accurately than general purpose probes, but they make less accurate amplitude measurements. They offer a higher bandwidth to cost ratio.

These probes must be terminated in a $50\ \Omega$ scope input. Input capacitance is much lower than high Z passive probes, typically 1 pF, but input resistance is also lower (500 to 5000 Ω typically). Although that DC loading degrades amplitude accuracy, the lower input capacitance reduces high frequency loading to the circuit under test. That makes Z_0 probes ideal for timing and phase measurements when amplitude accuracy is not a major concern.

Z_0 probes are useful for measurements up to 40 V.

High Voltage Probes

High voltage probes have attenuation factors in the 100X to 1000X range. The considerations that apply to other passive probes apply to high voltage probes with a few exceptions. Since the voltage range on high voltage probes varies from 1 kV to 20 kV (DC + peak AC), the probe head design is mechanically much larger than for a passive probe. High voltage probes have the added advantage of lower input capacitance (typically 2-3 pF).

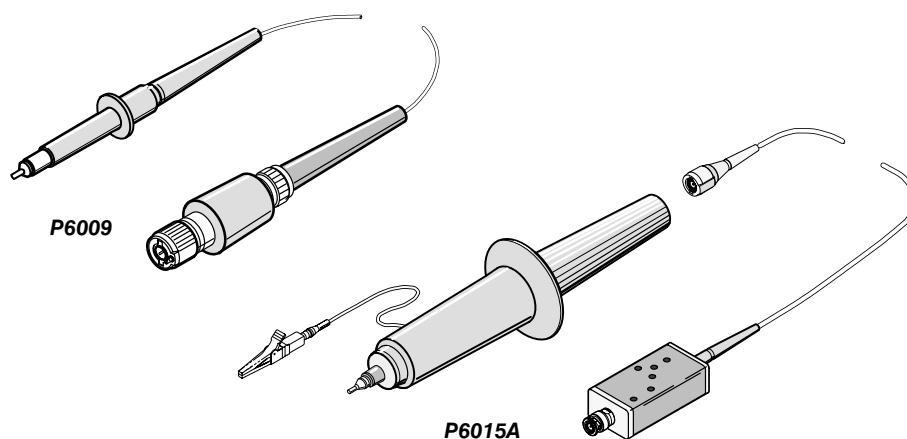

Figure 3-54: The P6009 and P6015A High Voltage Probes

Active Voltage Probes

Active voltage probes, sometimes called “FET” probes, use active circuit elements such as transistors. There are three classes of active probes:

- *High speed active*
- *Differential active*
- *Fixtured active*

Active voltage measuring probes use active circuit elements in the probe design to process signals from the circuit under test. All active probes require a source of power for their operation. Power is obtained either from an external power supply or from the oscilloscope itself. (Your digitizing oscilloscope powers the optional accessory P6205 probes.)

NOTE

When you connect an active probe to the oscilloscope (such as the P6205), the input impedance of the oscilloscope automatically becomes 50 Ω . If you then connect a passive probe (like the P6139A) you need to set the input impedance back to 1 M Ω . Vertical Control on page 3-136 explains how to change the input impedance.

High Speed Active Probes

Active probes offer low input capacitance (1 to 2 pF typical) while maintaining the higher input resistance of passive probes (10 k Ω to 10 M Ω). Like Z_O probes, active probes are useful for making accurate timing and phase measurements. However, they do not degrade the amplitude accuracy. Active probes typically have a dynamic range of ± 10 to ± 15 V.

Differential Probes

Differential probes determine the voltage drop between two points in a circuit under test. Differential probes let you simultaneously measure two points and to display the difference between the two voltages.

Active differential probes are stand-alone products designed to be used with 50 Ω inputs. The same characteristics that apply to active probes apply to active differential probes.

Fixtured Active Probes

In some small-geometry or dense circuitry applications, such as surface mounted devices (SMD), a hand-held probe is too big to be practical. You can instead use fixtured (or probe card mounted) active probes (or buffered

amplifiers) to precisely connect your instrument to your device-under-test. These probes have the same electrical characteristics as high speed, active probes but use a smaller mechanical design.

Current Probes

Current probes enable you to directly observe and measure current waveforms, which can be very different from voltage signals. Tektronix current probes are unique in that they can measure from DC to 1 GHz.

Two types of current probes are available: one that measures AC current only and AC/DC probes that utilize the Hall effect to accurately measure the AC and DC components of a signal. AC-only current probes use a transformer to convert AC current flux into a voltage signal to the oscilloscope and have a frequency response from a few hundred Hertz up to 1 GHz. AC/DC current probes include Hall effect semiconductor devices and provide frequency response from DC to 50 MHz.

Use a current probe by clipping its jaws around the wire carrying the current that you want to measure. (Unlike an ammeter which you must connect in series with the circuit.) Because current probes are non-invasive, with loading typically in the milliohm to low Ω range, they are especially useful where low loading of the circuit is important. Current probes can also make differential measurements by measuring the results of two opposing currents in two conductors in the jaws of the probe.

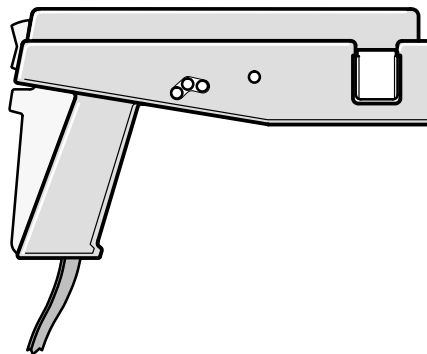

Figure 3-55: A6303 Current Probe Used in the AM 503S Opt. 03

Optical Probes

Optical probes let you blend the functions of an optical power meter with the high-speed analog waveform analysis capability of an oscilloscope. You have the capability of acquiring, displaying, and analyzing optical and electrical signals simultaneously.

Applications include measuring the transient optical properties of lasers, LEDs, electro-optic modulators, and flashlamps. You can also use these probes in the development, manufacturing, and maintenance of fiber optic control networks, local area networks (LANs), fiber-based systems based on the FDDI and SONET standard, optical disk devices, and high-speed fiber optic communications systems.

NOTE

When you connect any level 2 probe to the oscilloscope, the input impedance of the oscilloscope automatically becomes 50 Ω . If you then connect a high input impedance passive probe you need to set the input impedance back to 1 M Ω . Vertical Control, on page 3-136, explains how to change the input impedance.

Time-to-Voltage Converter

The instantaneous time-interval to voltage converter (TVC) continuously converts consecutive timing measurements to a time-interval versus time waveform.

Timing variations typically appear as left-to-right motion, or jitter, on an oscilloscope. Time base or trigger holdoff adjustments may improve display stability, but they do not show timing dynamics. The TVC untangles the often confusing waveforms and delivers a coherent real-time view.

The TVC adds three measurement functions to the voltage versus time capability of your oscilloscope: time delay versus time, pulse-width versus time, and period versus time.

Probes by Type

Table 3-6 lists TDS 600A compatible probes classified by type.

Table 3-6: TDS 600A Compatible Probes

Probe Type	Tektronix Model	Description
Passive, high impedance voltage	P6139A (std.)	10X, 500 MHz
	P6101A	1X, 15 MHz
Passive, SMD	P6563AS	20X, 500 MHz
Passive, low impedance Z_O	P6156	10X, 3.5 GHz, for 50 Ω inputs (1X, 20X, 100X optional)
Passive, high voltage	P6009	100X, 1.5 kV, DC + peak AC
	P6015A	1000X, 20 kV, DC + peak AC
Active, high speed voltage	P6204	DC to 1 GHz FET. DC Offset capability (requires Tektronix 1103 TekProbe Power Supply for offset capability)
Active, high speed voltage	P6205	DC to 750 MHz FET
Active, differential voltage	P6046	1X/10X, DC to 100 MHz
Active, fixtured voltage	A6501	Buffer Amplifier, 1 GHz, 1 M Ω , 10X
	P6501 Opt. 02	Microprobe with TekProbe Power Cable, 750 MHz, 1 M Ω , 10X
Current	AM 503S	AC/DC. Uses A6302 Current Probe.
	AM 503S Opt. 03	AC/DC. Uses A6303 Current Probe.
	P6021	AC. 120 Hz to 60 MHz.
	P6022	AC. 935 kHz to 120 MHz.
	CT-1/CT-2	Designed for permanent or semi-permanent in-circuit installation CT-1: 25 kHz to 1 GHz, 50 Ω input CT-2: 1.2 kHz to 200 MHz, 50 Ω input
	CT-4	Current Transformer for use with AM 503S and P6021. Peak pulse 1 kA, 0.5 Hz to 20 MHz with AM 503S
Logic Word Trigger	P6408	16 channel, one qualifier channel, TTL compatible, +5 V power supply required
Optical (Opto-Electronic Converters)	P6701A	500 to 950 nm, DC to 850 MHz, 1 V/mW
	P6703A	1100 to 1700 nm, DC to 1 GHz, 1 V/mW
	P6711	500 to 950 nm, DC to 250 MHz, 5 V/mW
	P6713	1100 to 1700 nm, DC to 300 MHz, 5 V/mW
Time-to-Voltage Converter	TVC 501	Time delay, pulse width and period measurements

Probes by Application

Another way to classify probes is by application. Different applications demand different probes. Use Table 3-7 to select a probe for your application.

Table 3-7: Probes by Application

Probe Type	Telecommunications & High-Speed Logic	Industrial Electronics	Consumer/Computer Electronics	High Energy Pulsed Power	Certification, Regulatory, & Compliance Testing
Passive, high-impedance voltage	P6139A ¹ P6101A ¹ P6563AS ¹	P6139A ^{1,2} P6101A ^{1,2} P6563AS ¹	P6139A ^{1,2,3} P6101A ¹ P6563AS ¹	P6139A ^{1,2,3} P6101A ^{1,2}	P6139A ^{1,2,3} P6101A ^{1,2}
Active, high-speed digital voltage	P6205 ^{2,3} P6204 ^{2,3}	P6205 ^{2,3}	P6205 ^{2,3} P6204 w/1103 power supply ^{2,3}	P6205 ^{2,3}	P6205 ^{2,3}
Low impedance Z _O (low capacitance)	P6156 ^{1,2,3}		P6156 ^{1,2,3}		
Passive, high voltage	P6009 ^{1,2}	P6009 ^{1,2,3} P6015A ^{1,2,3}	P6009 ^{1,2}	P6009 ^{1,2,3} P6015A ^{1,2,3}	P6009 ^{1,2,3} P6015A ^{1,2,3}
Active, differential voltage	P6046 ^{2,3}	P6046 ^{2,3}	P6046 ^{2,3}		
Current	AM 503S ^{2,3} P6021 ^{1,2}	AM 503S ^{2,3} P6021 ^{1,2} CT4 ^{1,2}	AM 503S ^{2,3} P6021 ^{1,2}	AM 503S ^{2,3} P6021 ^{1,2}	AM 503S ^{2,3} P6021 ^{1,2} CT1/2 ^{2,3} CT4 ^{1,2}
Fixtured	A6501 ^{2,3} P6501 ^{2,3}		A6501 ^{2,3} P6501 ^{2,3}		
Logic Word Trigger	P6408 ^{2,3}		P6408		
Optical	P6701A ^{2,3} P6703A ^{2,3} P6711 ^{2,3} P6713 ^{2,3}		P6701A ^{2,3} P6703A ^{2,3} P6711 ^{2,3} P6713 ^{2,3}		P6701A ^{2,3} P6703A ^{2,3} P6711 ^{2,3} P6713 ^{2,3}
Time-to-voltage converter	TVC 501 ^{2,3}	TVC 501 ^{2,3}	TVC 501 ^{2,3}	TVC 501 ^{2,3}	

¹Qualitative signal evaluation — use when a great deal of accuracy is not required, such as when making go/no go measurements.

²Functional testing — use when the device under test is being compared to some standard.

³Quantitative Signal Evaluation — use when detailed evaluation is needed.

Pulse Triggering

Pulse triggering can be very useful. For example, you might be testing a product with a glitch in the power supply. The glitch appears once a day. So instead of sitting by and waiting for it to appear, you can use pulse triggering to automatically capture your data.

There are three classes of pulse triggering: glitch, runt, and width.

- A *glitch* trigger occurs when the trigger source detects a pulse narrower (or wider) in width than some specified time. It can trigger on glitches of either polarity. Or you can set the glitch trigger to reject glitches of either polarity.
- A *runt* trigger occurs when the trigger source detects a short pulse that crosses one threshold but fails to cross a second threshold before recrossing the first. You can set the oscilloscope to detect positive or negative runt pulses.
- A *width* trigger occurs when the trigger source detects a pulse that is inside or, optionally, outside some specified time range (defined by the upper limit and lower limit). The oscilloscope can trigger on positive or negative width pulses.

Figure 3-56 shows the pulse trigger readouts. Table 3-8, on page 3-110, describes the choices for pulse triggers.

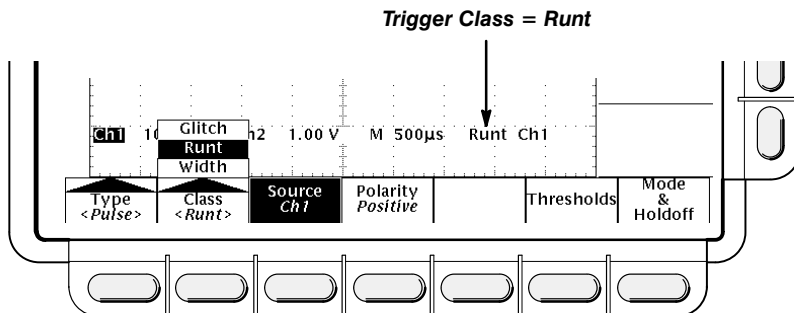









Figure 3-56: Pulse Trigger Readouts

Table 3-8: Pulse Trigger Definitions

Name	Definition
 Glitch positive	Triggering occurs if the oscilloscope detects positive spike widths less than the specified glitch time.
 Glitch negative	Triggering occurs if the oscilloscope detects negative spike widths less than the specified glitch time.
 Glitch either	Triggering occurs if the oscilloscope detects positive or negative widths less than the specified glitch time.
 Runt positive	Triggering occurs if the oscilloscope detects a positive pulse that crosses one threshold going positive but fails to cross a second threshold before recrossing the first going negative.
 Runt negative	Triggering occurs if the oscilloscope detects a negative going pulse that crosses one threshold going negative but fails to cross a second threshold before recrossing the first going positive.
 Runt either	Triggering occurs if the oscilloscope detects a positive or negative going pulse that crosses one threshold but fails to cross a second threshold before recrossing the first.
 Width positive	Triggering occurs if the oscilloscope finds a positive pulse with a width between, or optionally outside, the user-specified lower and upper time limits.
 Width negative	Triggering occurs if the oscilloscope finds a negative pulse with a width between, or optionally outside, the user-specified lower and upper time limits.

Operations Common to Glitch, Runt, and Width

The pulse trigger menus let you define the pulse source, select the mode (auto or normal), and adjust the holdoff. To bring up the Pulse Trigger menu:

Press **TRIGGER MENU** → **Type** (main) → **Pulse** (pop-up) → **Class** (main) → **Glitch, Runt, or Width** (pop-up) (see Figure 3-57).

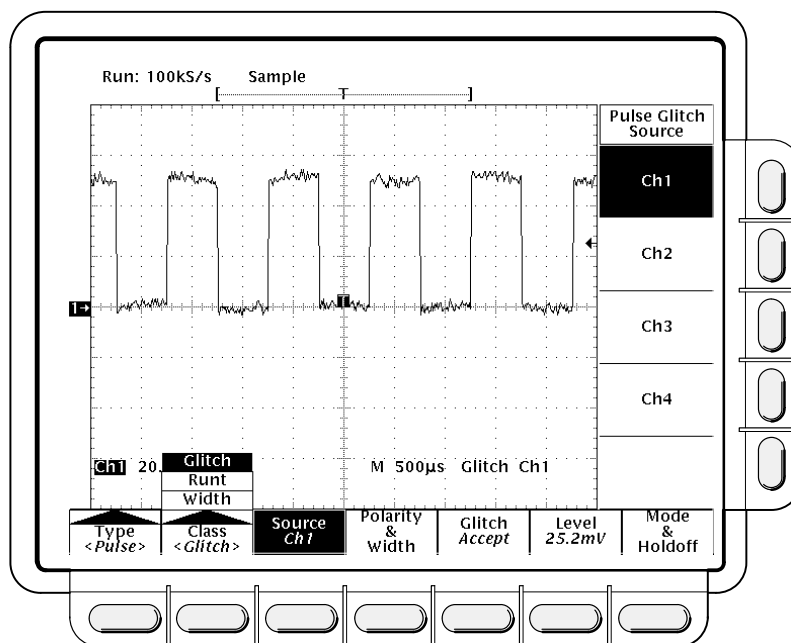

Figure 3-57: Main Trigger Menu — Glitch Class

Source

Use this main menu item to specify which channel becomes the pulse trigger source.

Press **TRIGGER MENU** → **Type** (main) → **Pulse** (pop-up) → **Source** (main) → **Ch1, Ch2, Ch3** (Ax1 on the TDS 620A), or **Ch4** (Ax2 on the TDS 620A) (side).

Mode & Holdoff

To change the holdoff time and select the trigger mode:

1. Press **TRIGGER MENU** → **Type** (main) → **Pulse** (pop-up) → **Mode and Holdoff** (main) → **Auto** or **Normal** (side).
 - In **Auto** mode the oscilloscope acquires a waveform after a specific time has elapsed even if a trigger does not occur. The amount of time the oscilloscope waits depends on the time base setting.

- In **Normal** mode the oscilloscope acquires a waveform only if there is a valid trigger. (You can force a single acquisition by pressing **FORCE TRIGGER**.)
2. To change the holdoff time, press **Holdoff** (side). Use the general purpose knob or the keypad to enter the value in percent.

Glitch Operations

When you select the pulse class **Glitch**, the oscilloscope will trigger on a pulse narrower (or wider) in width than some specified time.

Polarity & Width

This menu item lets you define the glitch in terms of polarity (positive, negative, or either) and width.

1. Press **TRIGGER MENU** → **Type** (main) → **Pulse** (pop-up) → **Polarity and Width** (main) → **Positive, Negative, or Either** (side).
 - Glitch **Positive** looks at positive-going pulses.
 - Glitch **Negative** looks at negative-going pulses.
 - Glitch **Either** looks at both positive and negative pulses.
2. Press **Width** (side), and set the glitch width using the general purpose knob or keypad.



Glitch (Accept or Reject)

To specify whether to trigger on glitches or filter out glitches using the **Glitch** main menu item, press **TRIGGER MENU** → **Type** (main) → **Pulse** (pop-up) → **Class** (main) → **Glitch** (pop-up) → **Glitch** (main) → **Accept Glitch** or **Reject Glitch** (side).

If you choose **Accept Glitch**, the oscilloscope will trigger only on pulses narrower than the width you specified. If you select **Reject Glitch**, it will trigger only on pulses wider than the specified width.

Level

To set the trigger level with the **Level** main menu (or the front panel trigger **LEVEL** knob), press **TRIGGER MENU** → **Type** (main) → **Pulse** (pop-up) → **Level** (main) → **Level, Set to TTL, Set to ECL, or Set to 50%** (side).

- If you select **Level**, enter a value with the general purpose knob or the keypad.
- If you select **Set to TTL**, the trigger level is set to the TTL switching threshold.
- If you select **Set to ECL**, the trigger level is set to the ECL switching threshold.

- If you select **Set to 50%**, you cause the digitizing oscilloscope to search for the point halfway between the peaks of the trigger source signal and set the trigger level to that point.

Runt Operation

When you select the pulse class **Runt**, the oscilloscope will trigger on a short pulse that crosses one threshold but fails to cross a second threshold before recrossing the first. To set up runt triggering:

1. Press **TRIGGER MENU** → **Type** (main) → **Pulse** (pop-up) → **Class** (main) → **Runt** (pop-up) → **Source** (main) → **Ch1, Ch2, Ch3** (**Ax1** on the TDS 620A), or **Ch4 (Ax2)** on the TDS 620A) (side). (See Figure 3-58.)
2. Press **Polarity** (main) → **Positive, Negative, or Either** (side).
3. Press **Thresholds** (main), and set the upper and lower thresholds for runt detection with the side menu selections and the keypad or the general purpose knob.

Polarity

Use this menu item to specify the direction of the runt pulse.

Press **TRIGGER MENU** → **Type** (main) → **Pulse** (pop-up) → **Class** (main) → **Runt** (pop-up) → **Polarity** (main) → **Positive, Negative, or Either** (side).

- **Positive** looks for positive-going runt pulses.
- **Negative** looks for negative-going runt pulses.
- **Either** looks for both positive and negative runt pulses.

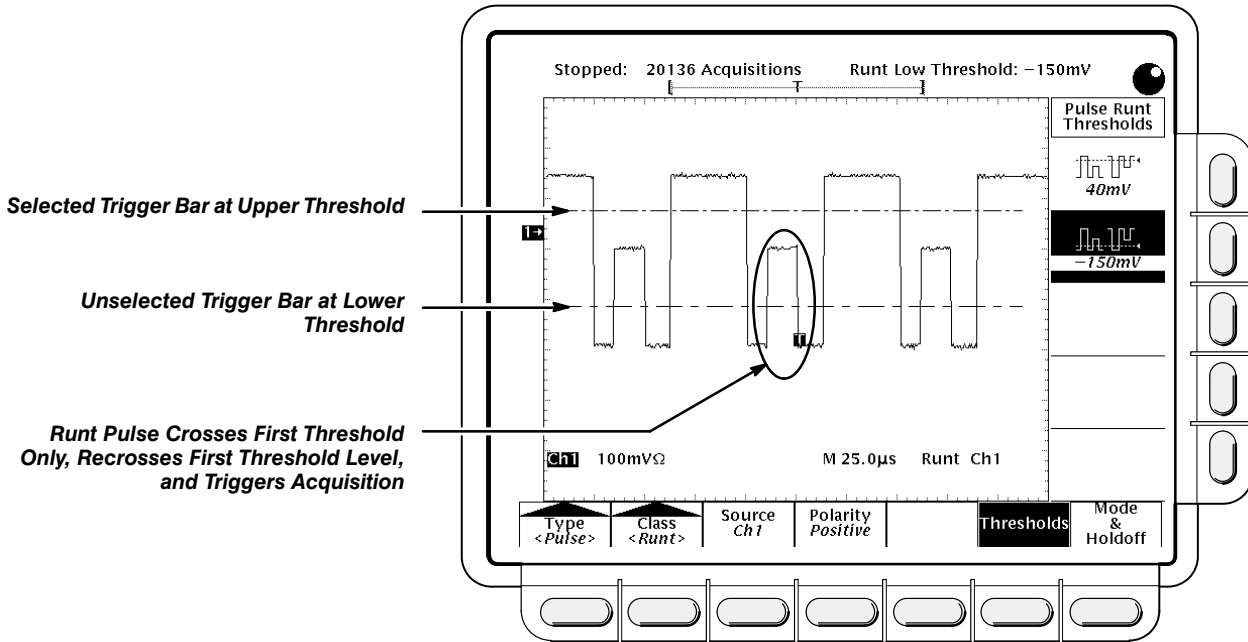

Figure 3-58: Main Trigger Menu—Runt Class

Thresholds

To set the two threshold levels used in detecting a runt pulse:

1. Press **TRIGGER MENU** → **Type** (main) → **Pulse** (pop-up) → **Class** (main) → **Runt** (pop-up) → **Thresholds** (main).
2. Use the general purpose knob or keypad to set the values for the high and low thresholds.

Hint: To use the Trigger Bar feature to set the threshold levels on the pulse train, press **DISPLAY** → **Readout Options** (main) → **Trigger Bar Style** (side) until **Long** appears in that menu item.

Note the position of the trigger indicator in Figure 3-58. Triggering occurs at the point the pulse returns over the first (lower) threshold going negative without crossing the second threshold level (upper). Be aware of the following considerations when using Runt triggering:

- When **Positive** is set in the **Polarity** side menu, the *lower* threshold must be first crossed going *positive*, then recrossed going *negative* without crossing the *upper* threshold at all.
- When **Negative** is set in the **Polarity** side menu, the *upper* threshold must be first crossed going *negative*, then recrossed going *positive* without crossing the *lower* threshold at all.
- When **Either** is set in the **Polarity** side menu, *one* threshold must be first crossed going in *either* direction, then recrossed going in the *opposite* direction without crossing the *other* threshold at all.

- Regardless of the polarity setting, triggering occurs at the point the runt pulse *recrosses* its first threshold.

Width Operation

When you select the pulse class **Width**, the oscilloscope will trigger on a pulse narrower (or wider) than some specified *range* of time (defined by the upper limit and lower limit).

Polarity

To define whether the pulses are positive or negative:

Press **TRIGGER MENU** → **Type** (main) → **Pulse** (pop-up) → **Class** (main) → **Width** (pop-up) → **Polarity** (main) → **Positive** or **Negative** (side).

Trig When

This menu item lets you establish the range of widths (in units of time) the trigger source will search for and whether to trigger on pulses that are outside this range or ones that fall within the range.

1. Press **TRIGGER MENU** → **Type** (main) → **Pulse** (pop-up) → **Class** (main) → **Width** (pop-up) → **Trig When** (main).
2. Press **Within Limits** (side) if you want the oscilloscope to trigger on pulses that fall within the specified range. If you want it to trigger on pulses that are outside the range, then press **Out of Limits** (side).
3. To set the range of pulse widths in units of time, press **Upper Limit** (side) and **Lower Limit** (side). Enter the values with the general purpose knob or keypad. The **Upper Limit** is the maximum valid pulse width the trigger source will look for. The **Lower Limit** is the minimum valid pulse width. The oscilloscope will always force the **Lower Limit** to be less than or equal to the **Upper Limit**.

Level

To set the trigger level with the **Level** main menu:

Press **TRIGGER MENU** → **Type** (main) → **Pulse** (pop-up) → **Class** (main) → **Width** (pop-up) → **Level** (main) → **Level**, **Set to TTL**, **Set to ECL**, or **Set to 50%** (side).

For More Information

See *Triggering*, on page 2-13.

See *Triggering*, on page 3-132.

Remote Communication

You may want to integrate your oscilloscope into a system environment and remotely control your oscilloscope or exchange measurement or waveform data with a computer. You can control your oscilloscope remotely via the IEEE Std 488.2–1987 (GPIB) interface.

GPIB Protocol

GPIB enables data transfers between instruments that support the GPIB protocols. It provides:

- Remote instrument control
- Bidirectional data transfer
- Device compatibility
- Status and event reporting

Besides the base protocols, Tektronix has defined codes and formats for messages to travel over the GPIB. Each device that follows these codes and formats, such as the TDS 620A, TDS 640A, & TDS 644A, supports standard commands. Use of instruments that support these commands can greatly simplify development of GPIB systems.

GPIB Interface Requirements

You can connect GPIB networks in many configurations if you follow these rules:

- No more than 15 devices, including the controller, can be on a single bus.
- Connect one device load every two meters (about six feet) of cable length to maintain bus electrical characteristics. (Generally, each instrument represents one device load on the bus.)
- The total cumulative cable length must not exceed 20 meters (about 65 feet).
- At least two-thirds of the device loads must be turned on when you use your network.
- There must be only one cable path from each device to each other device on your network (see Figure 3-59), and you must not create loop configurations.

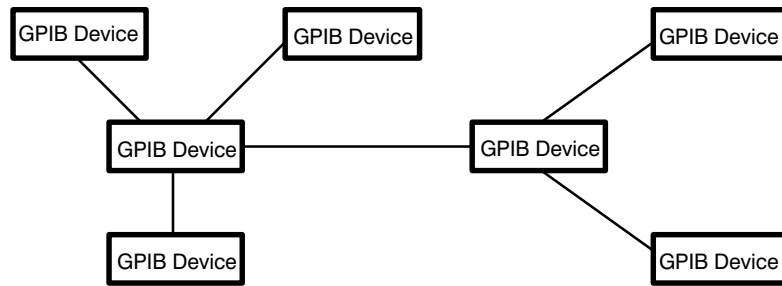

Figure 3-59: Typical GPIB Network Configuration

Cables — An IEEE Std 488.1–1987 GPIB cable (available from Tektronix, part number 012–0991–00) is required to connect two GPIB devices.

Connector — A 24-pin GPIB connector is located on the oscilloscope rear panel. The connector has a D-type shell and conforms to IEEE Std 488.1–1987. You can stack GPIB connectors on top of each other (see Figure 3-60).

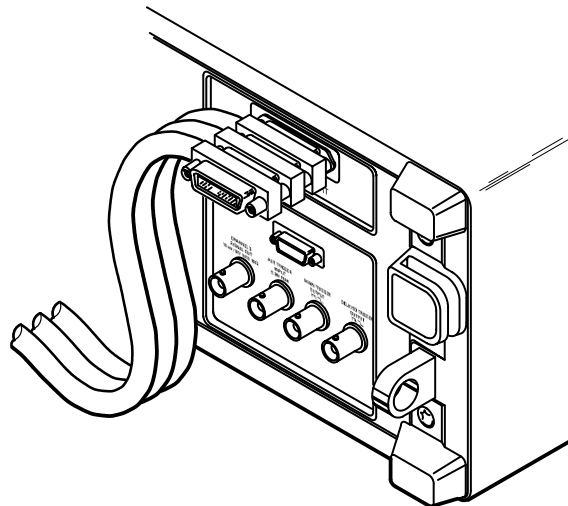

Figure 3-60: Stacking GPIB Connectors

GPIB Parameters

In the Utility menu you need to define two important GPIB parameters: *mode* and *address*. You need to set the mode to talker/listener, talk only, or off the bus. You also need to specify the primary communication address.

Operation

To set up remote communications, ensure that your oscilloscope is physically cabled to the controller and that the oscilloscope parameters are correctly set. Plug an IEEE Std 488.2–1987 GPIB cable into the GPIB connector on the oscilloscope rear panel and into the GPIB port on your controller (see Figure 3-61).

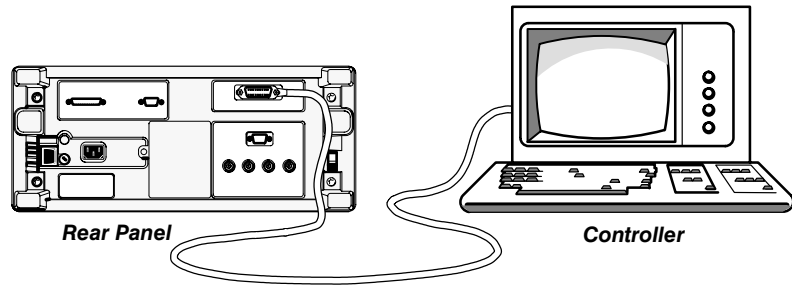

Figure 3-61: Connecting the Digitizing Oscilloscope to a Controller

To set remote communications parameters:

Press **SHIFT UTILITY** → **System** (main) → **I/O** (pop-up).

Port Selection

Now you need to configure the port to match the controller (see Figure 3-62).

Press **SHIFT UTILITY** → **System** (main) → **I/O** (pop-up) → **Port** (main) → **GPIB** (pop-up) → **Configure** (main) → **Talk/Listen Address**, **Hardcopy (Talk Only)**, or **Off Bus** (side)

- Choose **Talk/Listen Address** for normal, controller-based system operation. Use the general purpose knob or the keypad to define the address.
- Use **Hardcopy (Talk Only)** to use the hardcopy port of your digitizing oscilloscope. Once the port is configured this way, the oscilloscope will send the hardcopy data to any listeners on the bus when the **HARDCOPY** button is pressed.

If the port is configured any other way and the **HARDCOPY** button is pressed, an error will occur and the digitizing oscilloscope will display a message saying the selected hardcopy port is currently unavailable.

- Use **Off Bus** to disconnect the digitizing oscilloscope from the bus.

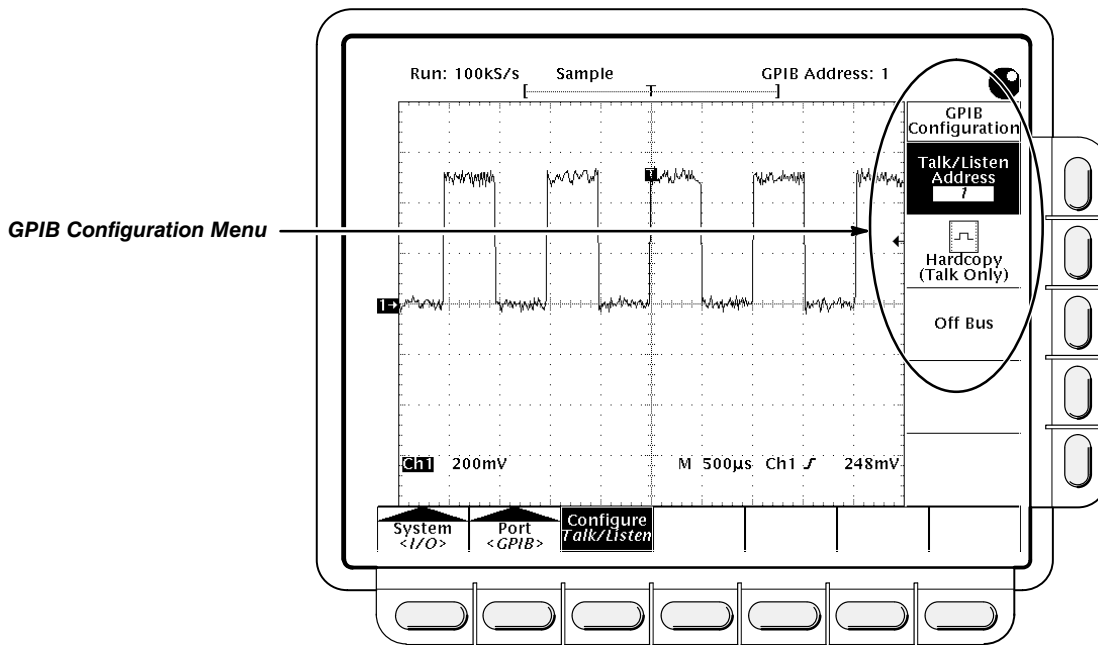

Figure 3-62: Utility Menu

For More Information

See *Hardcopy*, on page 3-57.

See the *TDS Family Digitizing Oscilloscopes Programmer Manual*.

Saving and Recalling Setups

You may want to save and reuse setups for many reasons. For example, after changing the setting during the course of an experiment, you may want to quickly return to your original setup. You can save and recall up to ten instrument setups from internal oscilloscope memory. The information is retained even when you turn the oscilloscope off or unplug it.

Operation

To save the current setup of the digitizing oscilloscope:

1. Press **SETUP** → **Save Current Setup** (main).



Before doing step 2 that follows, note that if you choose a setup location labeled **user**, you will overwrite the user setup previously stored there. You can store setups in setup locations labeled **factory** without disturbing previously stored setups.

2. To store to a setup internally, choose one of the ten internal storage locations from the side menu **To Setup 1**, **To Setup 2**, ... (see Figure 3-63). Now the current setup is stored in that location.

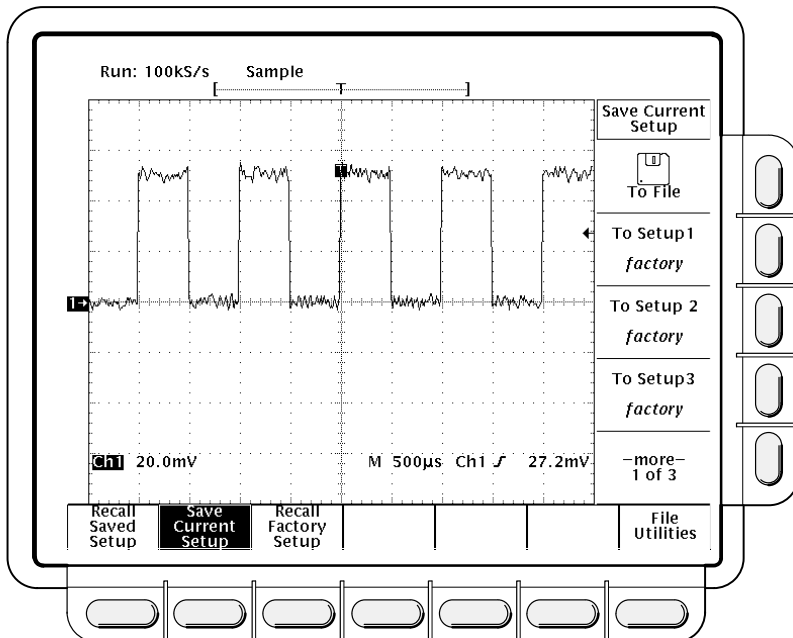

Figure 3-63: Save/Recall Setup Menu

To store a setup to disk (optional on the TDS 620A & TDS 640A), press **To File**. Then use the general purpose knob to select the exact file from the resulting scrollbar list. Finally, press the side-menu **Save To Selected File** to complete the operation.

Recalling a Setup

To recall a setup stored internally, press **SETUP → Recall Saved Setup** (main) → (**Recall Setup 1, Recall Setup 2 ...** (side)).

To recall a setup stored on disk (optional on the TDS 620A & TDS 640A), press **From File**. Then use the general purpose knob to select the exact file from the resulting scrollbar list. Only files with .set extensions will be displayed. Finally, press the side-menu **Recall From Selected File** to complete the operation.

Recalling a setup will not change the menu that is currently displayed. If you recall a setup that is labeled **factory** in the side menu, you will recall the factory setup. (The conventional method for recalling the factory setup is described below.)

Recalling the Factory Setup

To reset your oscilloscope to the factory defaults:

Press **SETUP → Recall Factory Setup** (main) → **OK Confirm Factory Init** (side).

See *Factory Initialization Settings*, on page A-23, for a list of the factory defaults.

Deleting All Setups and Waveforms—Tek Secure®

Sometimes you might use the digitizing oscilloscope to acquire waveforms that are confidential. Furthermore, before returning the oscilloscope to general usage, you might want to remove all such waveforms and any setups used to acquire them. (Be sure you *want* to remove *all* waveforms and setups, because once they are removed, you cannot retrieve them.) To use Tek Secure to remove all reference setups and waveforms (does not affect mass storage disk):

Press **SHIFT UTILITY → System** (main) → **Config** (pop-up) → **Tek Secure Erase Memory** (main) → **OK Erase Ref & Panel Memory** (side).

Executing Tek Secure accomplishes the following tasks:

- Replaces all waveforms in reference memories with zero sample values.
- Replaces the current front panel setup and all setups stored in setup memory with the factory setup.
- Calculates the checksums of all waveform memory and setup memory locations to verify successful completion of setup and waveform erasure.

Saving and Recalling Setups

- If the checksum calculation is unsuccessful, displays a warning message; if the checksum calculation is successful, displays a confirmation message.

Running File Utilities

To run file utilities (optional on the TDS 620A & TDS 640A), see the *File System* article on page 3-53.

For More Information

See *Tutorial Example 4: Saving Setups*, on page 1-24.

See *Appendix D, Factory Initialization Settings*, on page A-23.

Saving and Recalling Waveforms

You can store a waveform in any of the four internal reference memories of the digitizing oscilloscope. That information is retained even when you turn the oscilloscope off or unplug it. You can save any combination of different size waveform records.

The digitizing oscilloscope can display up to 11 waveforms at one time. That includes waveforms from the four input channels, four reference waveforms, and three math waveforms.

You will find saving waveforms useful when working with many waveforms and channels. If you have more waveforms than you can display, you can save one of the waveforms and then stop acquiring it. That lets you display another waveform without forcing you to lose the first one.

Operation

To save a waveform, do the following steps:

1. Select the channel that has the waveform you want to save.



Before doing step 2 that follows, note that if you choose a reference memory location labeled **active** (see Figure 3-64), you will overwrite the waveform that was previously stored there. You can store waveforms in reference locations labeled **empty** without disturbing previously stored waveforms.

2. To store a waveform internally, press save/recall **WAVEFORM** → **Save Waveform** (main) → **Ref1**, **Ref2**, **Ref3**, **Ref4**, or **File** (side).

To store a waveform to disk (optional on the TDS 620A & TDS 640A), press **To File**. Then use the general purpose knob to select the exact file from the resulting scrollbar list. Finally, press the side-menu **Save To Selected File** to complete the operation.

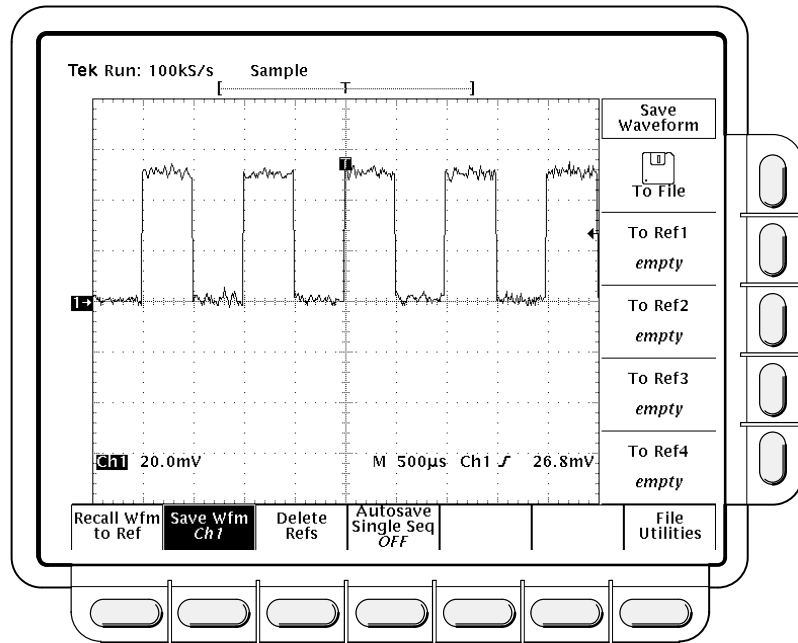

Figure 3-64: Save Waveform Menu

Deleting Waveforms

You can choose the **Delete Refs** main menu item and then select the references you no longer need from the side menu (**Delete Ref1**, **Delete Ref2**, **Delete Ref3**, **Delete Ref4**, or **Delete All Refs**).

Deleting All Waveforms and Setups

You can remove all stored reference waveforms and setups using the feature called Tek Secure. It is described under *Saving and Recalling Setups*. See “Deleting All Setups and Waveforms” on page 3-121.

Displaying a Saved Waveform

To display a waveform in internal reference memory:

Press **MORE** → **Ref1**, **Ref2**, **Ref3**, or **Ref4** (main).

Note that in Figure 3-65, the main menu items **Ref2**, **Ref3**, and **Ref4** appear shaded while **Ref1** does not. References that are empty appear shaded in the More main menu.

Recalling a Waveform From Disk

To recall a waveform from disk (optional on the TDS 620A & TDS 640A) to an internal reference memory, press save/recall **WAVEFORM** → **Recall Wfm To Ref**. Then use the general purpose knob to select the exact file from the

resulting scrollbar list. Only files with .WFM extensions are displayed. Finally, press from the side-menu **To Ref1**, **To Ref2**, **To Ref3**, or **To Ref4** choices to complete the operation.

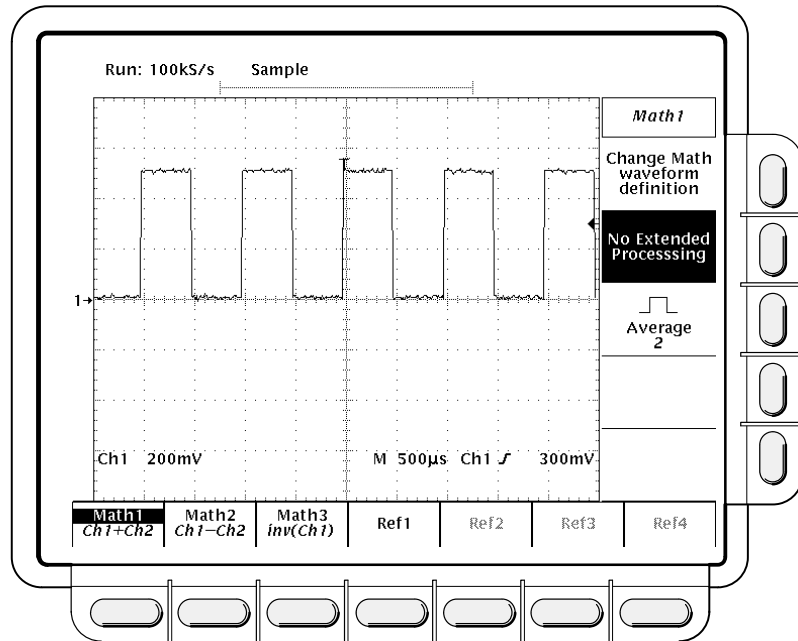

Figure 3-65: More Menu

Autosave (TDS 640A and 644A only)

To use autosave, press

Autosave (main) → **Autosave Single Seq ON** (side).

Also turn on **Single Acquisition Sequence** in the Acquire menu (see page 3-6).

To disable this feature, simply press

Autosave (main) → **Autosave Single Seq OFF** (side).

If you enable both autosave and single sequence, the TDS will save all live channels to reference waveforms at the completion of each single sequence event. All previous reference waveform data will be erased.

Running File Utilities

To run file utilities (optional on the TDS 620A & TDS 640A), see the *File System* article on page 3-53.

For More Information

See *Selecting Channels*, on page 3-126.

Selecting Channels

The *selected channel* is the channel that the digitizing oscilloscope applies all waveform-specific activities to (such as measurements or vertical scale and position).

Channel Readout and Reference Indicator

The channel readout shows the selected channel in inverse video in the lower left corner of the display. The channel reference indicator for the selected channel appears along the left side of the display. See Figure 3-66.

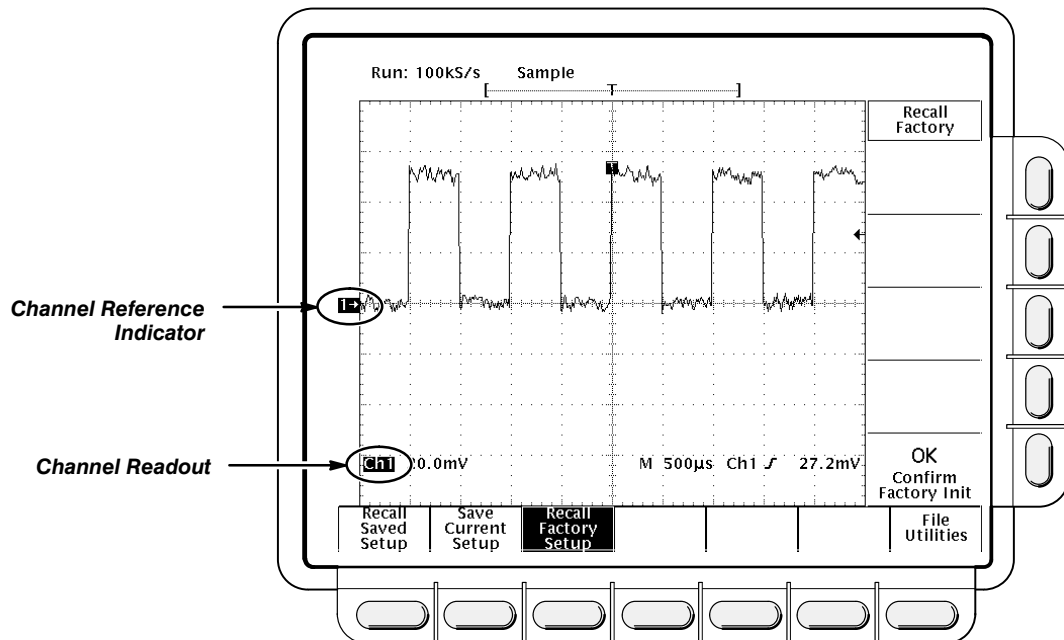

Figure 3-66: The Channel Readout

Channel Selection Buttons

Selecting channels on the TDS 600A series oscilloscopes is straightforward and easy.

The *channel selection* buttons are on the right of the display and are labeled **CH 1**, **CH 2**, **CH 3 (AUX 1)** on the TDS 620A), **CH 4 (AUX 2)** on the TDS 620A), and **MORE**. They determine which channel is selected. The **MORE** button allows you to select internally stored *Math* and *Ref* waveforms for display and manipulation.

The selected channel is indicated by the lighted LED above each button.

Operation

To selecting a channel:

Pressing **CH 1**, **CH 2**, **CH 3** (**AUX 1** on the TDS 620A), or **CH 4** (**AUX 2** on the TDS 620A) turns the channel on if it is not already on.

You do not use the channel selection buttons when triggering. Instead you select the trigger source in the Main Trigger menu or Delayed Trigger menu.

Removing Waveforms From the Display

The **WAVEFORM OFF** button turns OFF the display of the selected channel waveform. It will also remove from the display any automated measurements being made on that waveform.

When you turn off a waveform, the digitizing oscilloscope automatically selects the next highest priority waveform. Figure 3-67 shows how the oscilloscope prioritizes waveforms.

1. CH1
2. CH2
3. CH3 (**AUX 1** on the TDS 620A)
4. CH4 (**AUX 2** on the TDS 620A)

5. MATH1
6. MATH2
7. MATH3

8. REF1
9. REF2
10. REF3
11. REF4

Figure 3-67: Waveform Selection Priority

If you are turning off more than one waveform and you start by turning off a channel waveform, all channels will be turned off before going to the MORE waveforms. If you start by turning off the MORE waveforms, all the MORE waveforms will be turned off before going to the channel waveforms.

If you turn off a channel that is a trigger source, it continues to be the trigger source even though the waveform is not displayed.

For More Information

See *Saving and Recalling Waveforms*, on page 3-123.

See *Waveform Math*, on page 3-148.

Signal Path Compensation

This oscilloscope lets you compensate the internal signal path used to acquire the waveforms you acquire and measure. By executing the signal path compensation feature (SPC), you can optimize the oscilloscope capability to make accurate measurements based on the ambient temperature.

Run an SPC anytime you wish to ensure that the measurements you make are made with the most accuracy possible. You should also run an SPC if the temperature has changed more than 5° C since the last SPC was performed.

NOTE

When making measurements at volts/division settings less than or equal to 5 mV, you should run SPC at least once per week. Failure to do so may result in the oscilloscope not meeting warranted performance levels at those volts/div settings. (Warranted characteristics are listed in the Performance Verification manual.)

Operation

1. Power on the digitizing oscilloscope and allow a 20 minute warm-up before doing this procedure.
2. Disconnect any input signals you may have connected from all four input channels.



When doing steps 3 and 4, do not turn off the oscilloscope until signal-path compensation completes. If you interrupt (or lose) power to the instrument while signal-path compensation is running, a message is logged in the oscilloscope error log. If such a case occurs, rerun signal-path compensation.

3. Press **SHIFT UTILITY** → **System** (main) → **Cal** (pop-up) → **Signal Path** (main) → **OK Compensate Signal Paths** (side).
4. Wait for signal path compensation to complete (one to three minutes). While it progresses, a “clock” icon (shown at left) is displayed on-screen. When compensation completes, the status message will be updated to *Pass* or *Fail* in the main menu.
5. Verify the word **Pass** appears under **Signal Path** in the main menu. (See Figure 3-68.)



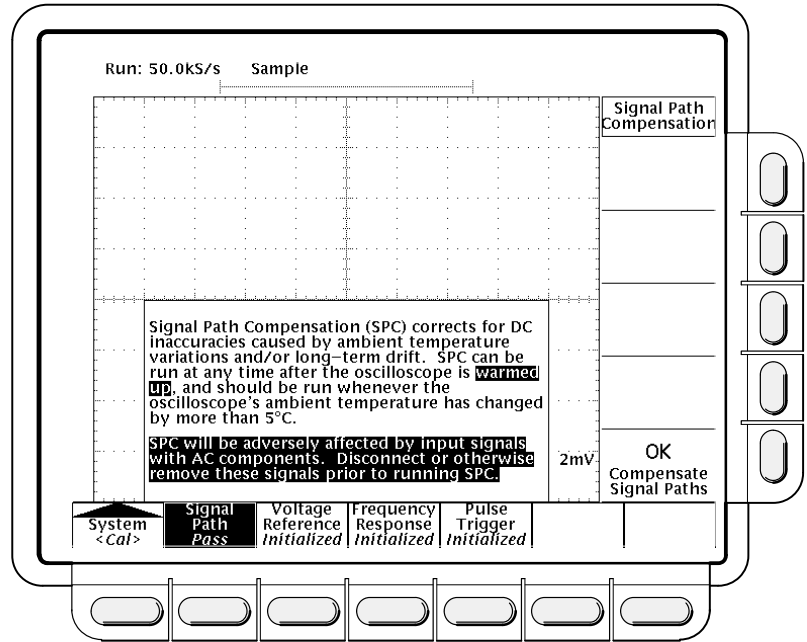

Figure 3-68: Performing a Signal Path Compensation

Status

The Status menu lets you see information about the oscilloscope state.

Operation

To operate the Status menu:

Press **SHIFT STATUS** → **Status** (main) → **System, Display, Trigger, Waveforms**, or **I/O** (side). Note: some oscilloscopes do not have a main Status menu. On these instruments, press **SHIFT STATUS** → **System, Display, Trigger, Waveforms**, or **I/O** (side).

- **System** displays information about the Horizontal, Zoom, Acquisition, Measure, and Hardcopy systems (Figure 3-69). This display also tells you the firmware version.
- **Display** provides parameter information about the display and color systems.
- **Trigger** displays parameter information about the triggers.
- **Waveforms** displays information about the various waveforms, including live, math, and reference.
- **I/O** displays information about the I/O port(s).

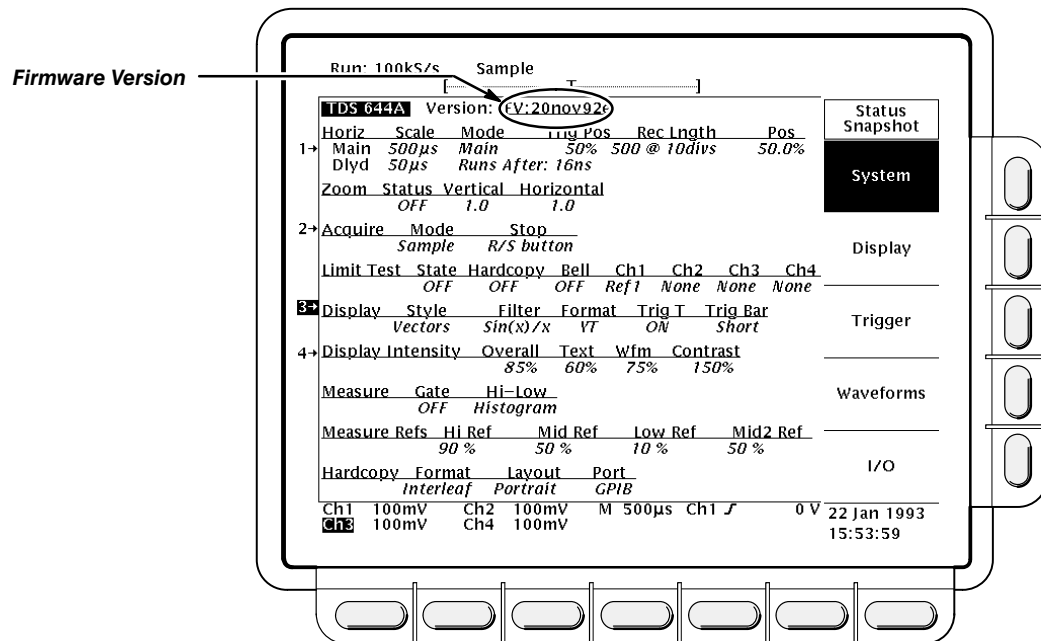

Figure 3-69: Status Menu — System

Banner

To display the banner (firmware version, options, copyright, and patents):

NOTE

Some TDS 644A oscilloscopes do not have a Status main menu with a banner. However, all instruments display the banner briefly at power-on.

Press **SHIFT STATUS** → **Banner** (main) (see Figure 3-70).

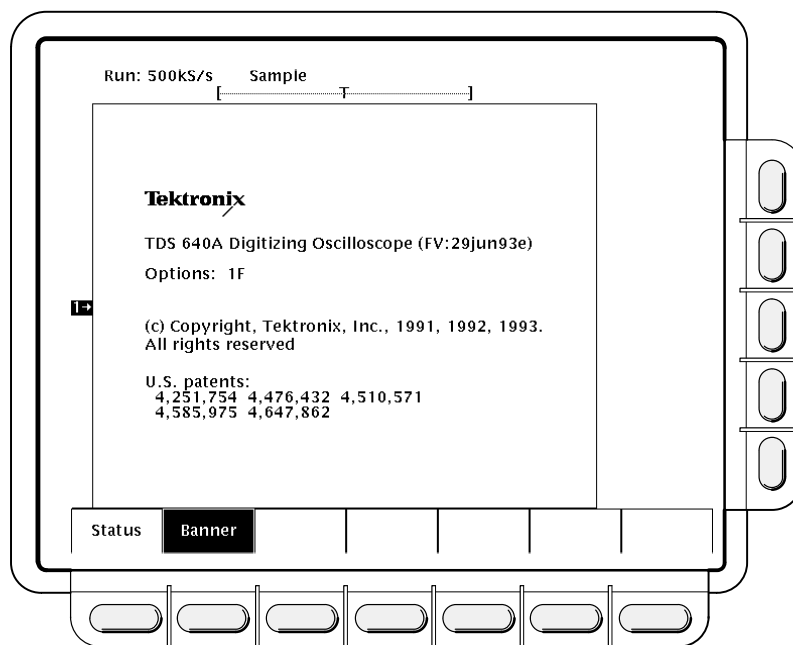

Figure 3-70: Banner Display

Triggering

Triggers determine when the digitizing oscilloscope starts acquiring and displaying a waveform. The TDS 600A has four types of trigger: edge, logic, pulse, and, with option 5, video.

Although these triggers are unique, they have some common characteristics that can be defined and modified using the Trigger menu, buttons, and knob. This article discusses these common characteristics.

To learn about the general concept of triggering, see *Triggering* in the *Operating Basics* section. To learn more about using specific triggers and using the delayed trigger system, see *For More Information* on page 3-135.

Trigger Button and Knobs

The trigger buttons and knob let you quickly adjust the trigger level or force a trigger (see Figure 3-71).

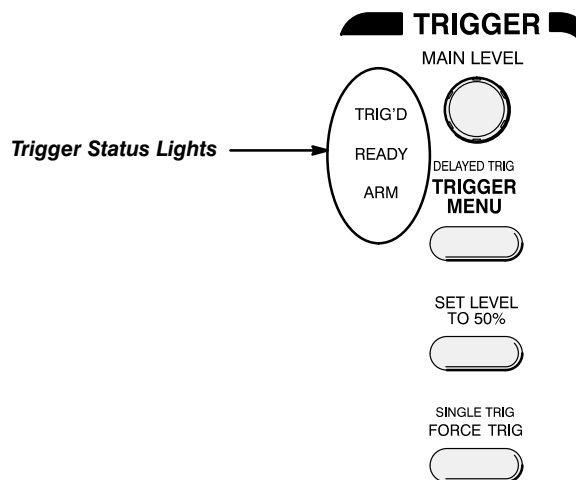

Figure 3-71: TRIGGER Controls and Status Lights

MAIN LEVEL Knob

The **MAIN LEVEL** knob lets you manually change the trigger level when triggering in Edge mode or certain threshold levels when triggering in Logic or Pulse modes. It adjusts the trigger level (or threshold level) instantaneously no matter what menu, if any, is displayed.

To Set to 50%

You can quickly obtain an edge or pulse trigger (except for the Runt class) by pressing **SET LEVEL TO 50%**. The oscilloscope sets the trigger level to the halfway point between the peaks of the trigger signal.

You can also set the level to 50% in the Trigger menu under the main menu item **Level** if Edge or Pulse (except for Runt class) is selected.

Note that the **MAIN LEVEL** knob and menu items apply only to the main trigger level. To modify the delayed trigger level, use the **Level** item in the Delayed Trigger menu.

Force Trigger

By pressing the **FORCE TRIG** front panel button, you can force the oscilloscope to immediately start acquiring a waveform record even without a trigger event. Forcing a trigger is useful when in normal trigger mode and the input signal is not supplying a valid trigger. By pressing **FORCE TRIG**, you can quickly confirm that there is a signal present for the oscilloscope to acquire. Once that is established, you can determine how to trigger on it (press **SET LEVEL TO 50%**, check trigger source setting, etc.).

The oscilloscope recognizes and acts upon **FORCE TRIG** even when you press it before the end of pretrigger holdoff. However, the button has no effect if the acquisition system is stopped.

Single Trigger

If your goal is to act on the next valid trigger event and then stop, press **SHIFT FORCE TRIG**. Now you can initiate the single sequence of acquisitions by pressing the **RUN/STOP** button.

To leave Single Trig mode, press **SHIFT ACQUIRE MENU → Stop After** (main) → **RUN/STOP Button Only** (side).

See the description under “Stop After” on page 3-6 for further discussion of single sequence acquisitions.

Readouts

The digitizing oscilloscope has display readouts and status lights dedicated to monitoring the trigger circuitry.

Trigger Status Lights

There are three status lights in the Trigger control area (Figure 3-71) indicating the state of the trigger circuitry. The lights are labeled **TRIG'D**, **READY**, and **ARM**.

- When **TRIG'D** is lighted, it means the digitizing oscilloscope has recognized a valid trigger and is filling the posttrigger portion of the waveform.

- When **READY** is lighted, it means the digitizing oscilloscope can accept a valid trigger event, and the digitizing oscilloscope is waiting for that event to occur.
- When **ARM** is lighted, it means the trigger circuitry is filling the pretrigger portion of the waveform record.
- When both **TRIG'D** and **READY** are lighted, it means the digitizing oscilloscope has recognized a valid main trigger and is waiting for a delayed trigger. When the digitizing oscilloscope recognizes a delayed trigger, it will fill in the posttrigger portion of the delayed waveform.
- When **ARM**, **TRIG'D**, and **READY** are all off, the digitizer is stopped.

Trigger Display Readout

At the bottom of the display, the Trigger readout shows some of the key trigger parameters (Figure 3-72). The readouts are different for edge, logic and pulse triggers.

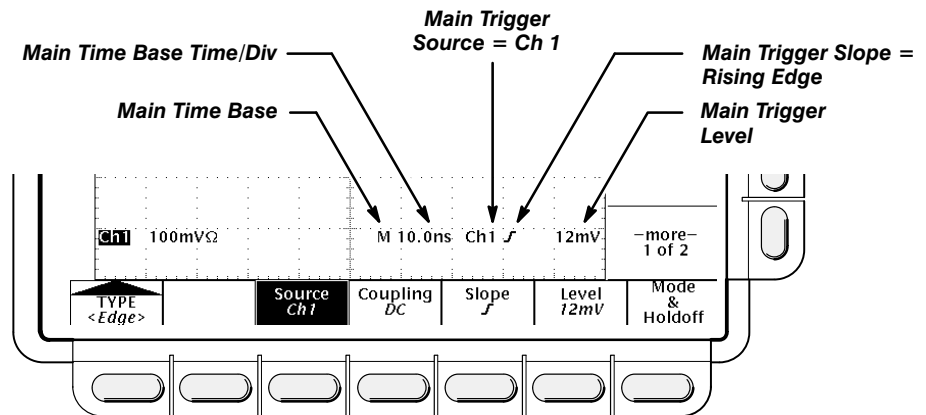

Figure 3-72: Example Trigger Readouts

The record view at the top of the display shows the location of the trigger signal in the waveform record and with respect to the display (see Figure 3-73).

Trigger Position and Level Indicators

In addition to the numerical readouts of trigger level, there are also graphic indicators of trigger position and level which you can optionally display. These indicators are the trigger point indicator, the long trigger level bar, and the short trigger level bar. Figure 3-73 shows the trigger point indicator and short-style trigger level bar.

The trigger point indicator shows position. It can be positioned horizontally off screen, especially with long record length settings. The trigger level bar shows only the trigger level. It remains on screen, regardless of the horizontal position, as long as the channel providing the trigger source is displayed.

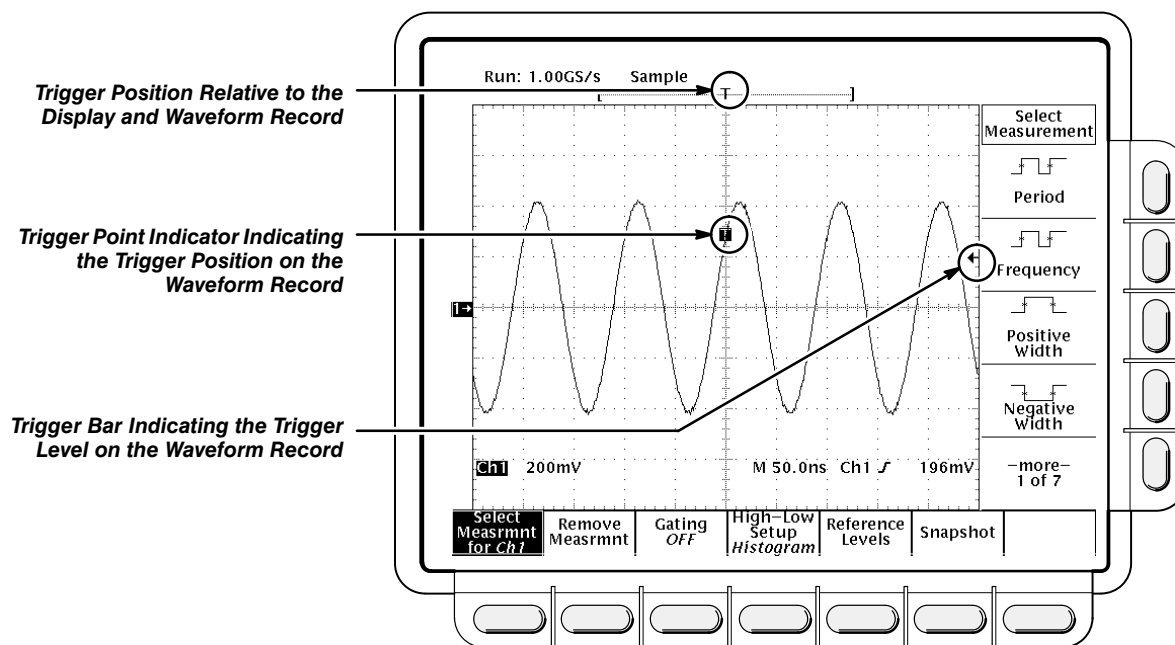

Figure 3-73: Record View, Trigger Position, and Trigger Level Bar Readouts

Both the trigger point indicator and level bar are displayed from the Display menu. See *Display Readout* on page 3-28 for more information.

Trigger Menu

Each trigger type (edge, logic, and pulse) has its own main trigger menu, which is described in a separate part of this section (see *For More Information*).

To select the trigger type, press **TRIGGER MENU** → **Type** (main) → **Edge**, **Logic**, or **Pulse** (pop-up).

For More Information

See *Delay Triggering*, on page 3-20.

See *Edge Triggering*, on page 3-32.

See *Logic Triggering*, on page 3-75.

See *Pulse Triggering*, on page 3-109.

See *Triggering*, on page 2-13.

See the *Option 05 Video Trigger Interface Instruction Manual*, Tektronix part number 070-8748-XX.

Vertical Control

You can control the vertical position and scale of the selected waveform using the vertical menu and knobs.

Vertical Knobs

By changing the vertical scale, you can focus on a particular portion of a waveform. By adjusting the vertical position, you can move the waveform up or down on the display. That is particularly useful when you are comparing two or more waveforms.

To change the vertical scale and position, use the vertical **POSITION** and vertical **SCALE** knobs. The vertical controls only affect the selected waveform.

The **POSITION** knob simply adds screen divisions to the reference point of the selected waveform. Adding divisions moves the waveform up and subtracting them moves the waveform down. You also can adjust the waveform position using the offset option in the Vertical menu (discussed later in this article).

If you want the **POSITION** knob to move faster, press the **SHIFT** button. When the light above the **SHIFT** button is on and the display says **Coarse Knobs** in the upper right corner, the **POSITION** knob speeds up significantly.

Vertical Readouts

The *Vertical readout* at the lower part of the display shows each displayed channel (the selected channel is in inverse video), and its volts/division setting (see Figure 3-74).

Vertical Menu

The Vertical menu (Figure 3-74) lets you select the coupling, bandwidth, and offset for the selected waveform. It also lets you numerically change the position or scale instead of using the vertical knobs.

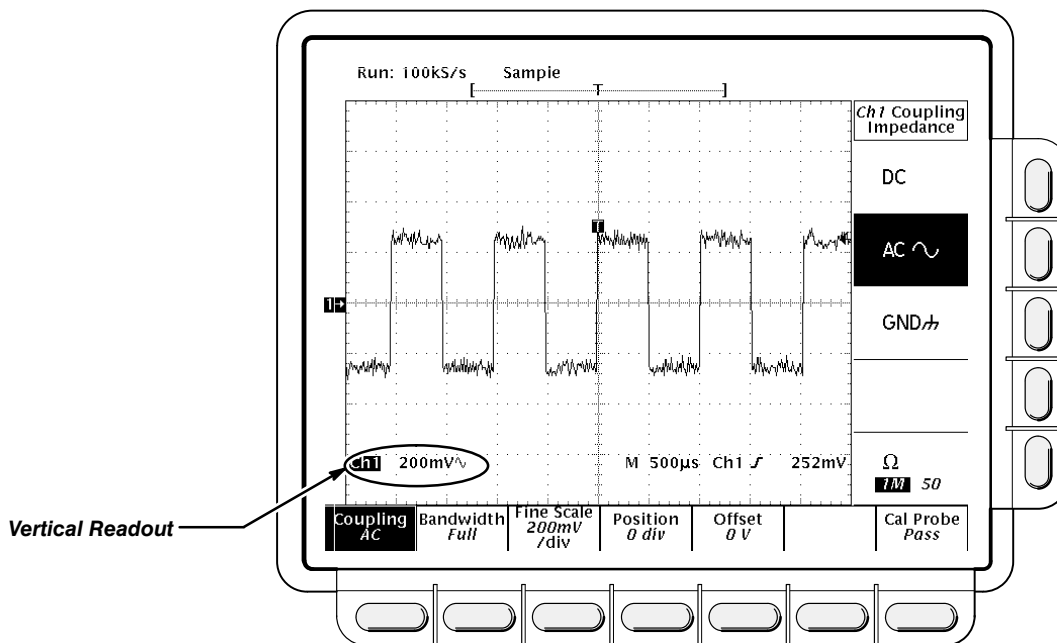



Figure 3-74: Vertical Readouts and Channel Menu

Coupling

To choose the type of coupling for attaching the input signal to the vertical attenuator for the selected channel and to set its input impedance:

Press **VERTICAL MENU** → **Coupling** (main) → **DC**, **AC**, **GND**, or **Ω** (side).

- | | |
|---|---|
| DC | ■ DC coupling shows both the AC and DC components of an input signal. |
| AC  | ■ AC coupling shows only the alternating components of an input signal. |
| GND  | ■ Ground (GND) coupling disconnects the input signal from the acquisition. |
| Ω | ■ Input impedance lets you select either 1 MΩ or 50 Ω impedance. |

NOTE

If you select 50 Ω impedance with AC coupling, the digitizing oscilloscope will not accurately display frequencies under 200 kHz.

Also, when you connect an active probe to the oscilloscope (such as the P6205), the input impedance of the oscilloscope automatically becomes 50 Ω. If you then connect a passive probe (like the P6139A), you need to set the input impedance back to 1 MΩ.

Bandwidth

To eliminate the higher frequency components, change the bandwidth of the selected channel:

Press **VERTICAL MENU** → **Bandwidth** (main) → **Full**, **100 MHz**, or **20 MHz** (side).

Fine Scale

Press **VERTICAL MENU** → **Fine Scale** (main) to make fine adjustments to the vertical scale using the general purpose knob or the keypad.

Position

Press **VERTICAL MENU** → **Position** (main) to let the general purpose knob control the vertical position. Press **Set to 0 divs** (side) if you want to reset the reference point of the selected waveform to the center of the display.

Offset

Offset lets you subtract DC bias from the waveform, so the oscilloscope can acquire the exact part of the waveform you are interested in.

Offset is useful when you want to examine a waveform with a DC bias. For example, you might be trying to look at a small ripple on a power supply output. It may be a 100 mV ripple on top of a 15 V supply. Using offset, you can display the ripple and scale it to meet your needs.

To use offset, press **VERTICAL MENU** → **Offset** (main). Use the general purpose knob to control the vertical offset. Press **Set to 0 V** (side) if you want to reset the offset to zero.

For More Information

See *Acquisition*, on page 2-19.

See *Scaling and Positioning Waveforms*, on page 2-22.

Waveform Differentiation

Advanced DSP Math (optional on TDS 620A & TDS 640A), provides *waveform differentiation* that allows you to display a derivative math waveform that indicates the instantaneous rate of change of the waveform acquired. Such waveforms are used in the measurement of slew rate of amplifiers and in educational applications. You can store and display a derivative math waveform in a reference memory, then use it as a source for another derivative waveform. The result is the second derivative of the waveform that was first differentiated.

Description

The math waveform, derived from the sampled waveform, is computed based on the following equation:

$$Y_n = (X_{(n+1)} - X_n) \frac{1}{T}$$

Where: *X* is the source waveform
Y is the derivative math waveform
T is the time between samples

Since the resultant math waveform is a derivative waveform, its vertical scale is in volts/second (its horizontal scale is in seconds). The source signal is differentiated over its entire record length; therefore, the math waveform record length equals that of the source waveform.

Operation

To obtain a derivative math waveform:

1. Connect the waveform to the desired channel input and select that channel.
2. Adjust the vertical and horizontal scales and trigger the display (or press **AUTOSET**).
3. Press **MORE** → **Math1**, **Math2**, or **Math3** (main) → **Change Math Definition** (side) → **Single Wfm Math** (main). See Figure 3-21.
4. Press **Set Single Source to** (side). Repeatedly press the same button (or use the general purpose knob) until the channel source selected in step 1 appears in the menu label.

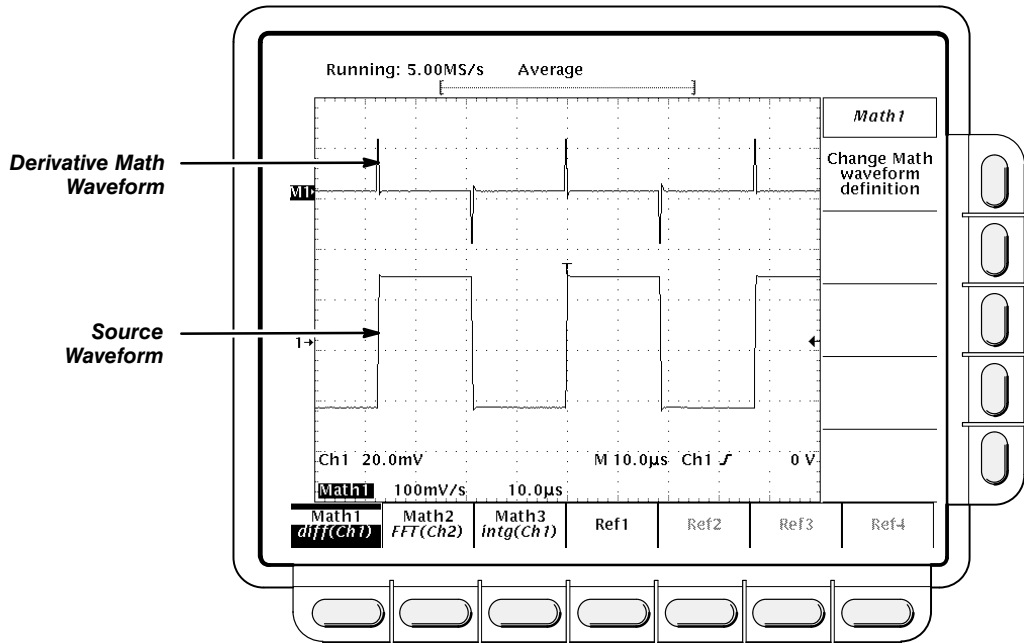

Figure 3-75: Derivative Math Waveform

5. Press **Set Function to** (side). Repeatedly press the same button (or use the general purpose knob) until **diff** appears in the menu label.
6. Press **OK Create Math Wfm** (side) to display the derivative of the waveform you input in step 1.

You should now have your derivative math waveform on screen. Use the Vertical **SCALE** and **POSITION** knobs to size and position your waveform as you require.

Automated Measurements of a Derivative Waveform

Once you have displayed your derivative math waveform, you can use automated measurements to make various parameter measurements. Do the following steps to display automated measurements of the waveform:

1. Be sure **MORE** is selected in the channel selection buttons and that the differentiated math waveform is selected in the **More** main menu.
2. Press **MEASURE** → **Select Measrmnt** (main).
3. Select up to four measurements in the side menu (see Figure 3-76).

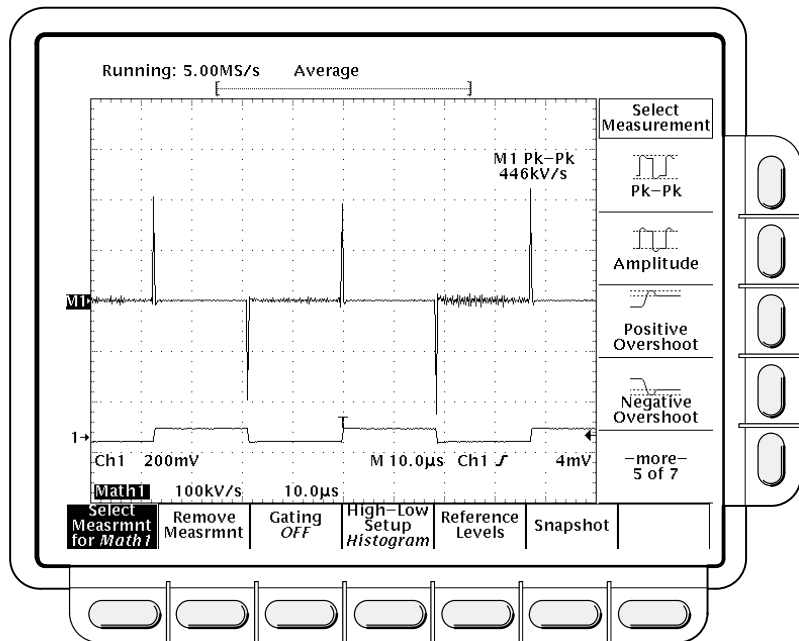

Figure 3-76: Peak-Peak Amplitude Measurement of a Derivative Waveform

Cursor Measurement of a Derivative Waveform

You can also use cursors to measure derivative waveforms. Use the same procedure as is found under *Waveform Integration* on page 3-144. When using that procedure, note that the amplitude measurements on a derivative waveform will be in volts per second rather than in volt-seconds as is indicated for the integral waveform measured in the procedure.

Usage Considerations

When creating differentiated math waveforms from live channel waveforms, consider the following topics.

Offset, Position, and Scale

Note the following tips for obtaining a good display:

- You should scale and position the source waveform so it is contained on screen. (Off screen waveforms may be clipped, resulting in errors in the derivative waveform).
- You can use vertical position and vertical offset to position your *source* waveform. The vertical position and vertical offset will not affect your derivative waveform unless you position the source waveform off screen so it is clipped.

- When using the vertical scale knob to scale the source waveform, note that it also scales your derivative waveform.

Because of the method the oscilloscope uses to scale the source waveform before differentiating that waveform, the derivative math waveform may be too large vertically to fit on screen — even if the source waveform is only a few divisions on screen. You can use Zoom to reduce the size of the waveform on screen (see *Zoom* that follows), but if your waveform is clipped before zooming, it will still be clipped after it is zoomed.

If your math waveform is a narrow differentiated pulse, it may not appear to be clipped when viewed on screen. You can detect if your derivative math waveform is clipped by expanding it horizontally using Zoom so you can see the clipped portion. Also, the automated measurement **Pk-Pk** will display a clipping error message if turned on (see *Automated Measurements of a Derivative Waveform* on page 3-140).

If your derivative waveform is clipped, try either of the following methods to eliminate clipping:

- Reduce the size of the source waveform on screen. (Select the source channel and use the vertical **SCALE** knob.)
- Expand the waveform horizontally on screen. (Select the source channel and increase the horizontal scale using the horizontal **SCALE** knob.) For instance, if you display the source waveform illustrated in Figure 3-75 on page 3-140 so its rising and falling edges are displayed over more horizontal divisions, the amplitude of the corresponding derivative pulse will decrease.

Whichever method you use, be sure Zoom is off and the zoom factors are reset (see *Zoom* below).

Zoom

Once you have your waveform optimally displayed, you can also magnify (or contract) it vertically and horizontally to inspect any feature. Just be sure the differentiated waveform is the selected waveform. (Press **MORE**, then select the differentiated waveform in the More main menu. Then use the Vertical and Horizontal **SCALE** knob to adjust the math waveform size.)

If you wish to see the zoom factor (2X, 5X, etc.), you need to turn zoom on: press **ZOOM → ON** (side). The vertical and horizontal zoom factors appear on screen.

Whether zoom is on or off, you can press **Reset Zoom Factors** (side) to return the zoomed derivative waveform to no magnification.

For More Information

See *Waveform Integration*, on page 3-143.

See *Fast Fourier Transforms*, on page 3-36.

See *Waveform Math*, on page 3-148.

Waveform Integration

Advanced DSP Math (optional on TDS 620A & TDS 640A), provides *waveform integration* that allows you to display an integral math waveform that is an integrated version of the acquired waveform. Such waveforms find use in the following applications:

- Measuring of power and energy, such as in switching power supplies
- Characterizing mechanical transducers, as when integrating the output of an accelerometer to obtain velocity

Description

The integral math waveform, derived from the sampled waveform, is computed based on the following equation:

$$y(n) = scale \sum_{i=1}^n \frac{x(i) + x(i-1)}{2} T$$

Where: $x(i)$ is the source waveform
 $y(n)$ is a point in the integral math waveform
 $scale$ is the output scale factor
 T is the time between samples

Since the resultant math waveform is an integral waveform, its vertical scale is in volt-seconds (its horizontal scale is in seconds). The source signal is integrated over its entire record length; therefore, the math waveform record length equals that of the source waveform.

Operation

To obtain an integral math waveform:

1. Connect the waveform to the desired channel input and select that channel.
2. Adjust the vertical and horizontal scales and trigger the display (or press **AUTOSET**).
3. Press **MORE** → **Math1**, **Math2**, or **Math3** (main) → **Change Math waveform definition** (side) → **Single Wfm Math** (main).
4. Press **Set Single Source to** (side). Repeatedly press the same button until the channel source selected in step 1 appears in the menu label.

5. Press **Set Function to** (side). Repeatedly press the same button until **intg** appears in the menu label.
6. Press **OK Create Math Waveform** (side) to turn on the integral math waveform.

You should now have your integral math waveform on screen. See Figure 3-77. Use the Vertical **SCALE** and **POSITION** knobs to size and position your waveform as you require.

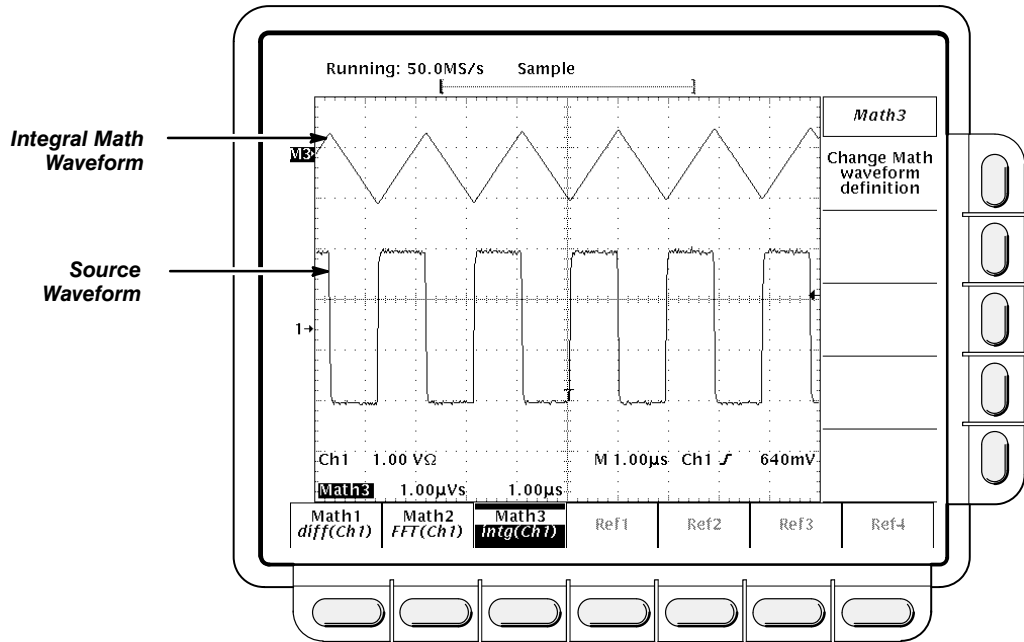

Figure 3-77: Integral Math Waveform

Cursor Measurements of an Integral Waveform

Once you have displayed your integrated math waveform, use cursors to measure its voltage over time.

1. Be sure **MORE** is selected (illuminated) in the channel selection buttons and that the integrated math waveform is selected in the **More** main menu.
2. Press **CURSOR → Mode** (main) → **Independent** (side) → **Function** (main) → **H Bars** (side).
3. Use the general purpose knob to align the selected cursor (solid) to the top (or to any amplitude level you choose).
4. Press **SELECT** to select the other cursor.
5. Use the general purpose knob to align the selected cursor (to the bottom (or to any amplitude level you choose)).

- Read the integrated voltage over time between the cursors in volt-seconds from the Δ : readout. Read the integrated voltage over time between the selected cursor and the reference indicator of the math waveform from the @: readout. See Figure 3-78.

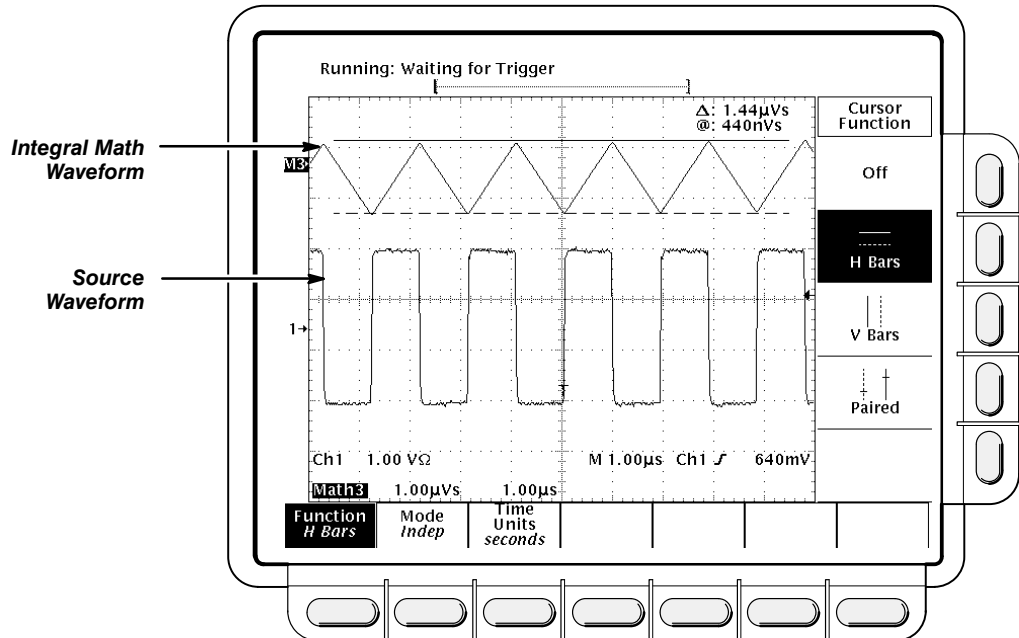

Figure 3-78: H Bars Cursors Measure an Integral Math Waveform

- Press **Function** (main) → **V Bars** (side). Use the general purpose knob to align one of the two vertical cursors to a point of interest along the horizontal axis of the waveform.
- Press **SELECT** to select the alternate cursor.
- Align the alternate cursor to another point of interest on the math waveform.
- Read the time difference between the cursors from the Δ : readout. Read the time difference between the selected cursor and the trigger point for the *source* waveform from the @: readout.
- Press **Function** (main) → **Paired** (side).
- Use the technique just outlined to place the long vertical bar of each paired cursor to the points along the horizontal axis you are interested in.
- Read the following values from the cursor readouts:
 - Read the integrated voltage over time between the Xs of both paired cursors in volt-seconds from the Δ : readout.

- Read the integrated voltage over time between the *X* of the selected cursor and the reference indicator of the math waveform from the @: readout.
- Read the time difference between the *long* vertical bars of the paired cursors from the Δ: readout.

Automated Measurements of a Integral Waveform

You can also use automated measurements to measure integral math waveforms. Use the same procedure as is found under *Waveform Differentiation* on page 3-140. When using that procedure, note that your measurements on an integral waveform will be in volt-seconds rather than in volts per second as is indicated for the differential waveform measured in the procedure.

Usage Considerations

When creating integrated math waveforms from live channel waveforms, consider the following topics.

Offset, Position, and Scale

Note the following requirements for obtaining a good display:

- You should scale and position the source waveform so it is contained on screen. (Off screen waveforms may be clipped, which will result in errors in the integral waveform).
- You can use vertical position and vertical offset to position your source waveform. The vertical position and vertical offset will not affect your integral waveform unless you position the source waveform off screen so it is clipped.
- When using the vertical scale knob to scale the source waveform, note that it also scales your integral waveform.

DC Offset

The source waveforms that you connect to the oscilloscope often have a DC offset component. The oscilloscope integrates this offset along with the time varying portions of your waveform. Even a few divisions of offset in the source waveform may be enough to ensure that the integral waveform saturates (clips), especially with long record lengths.

You may be able to avoid saturating your integral waveform if you choose a shorter record length. (Press **HORIZONTAL MENU** → **Record Length** (main).) Reducing the sample rate (use the **HORIZONTAL SCALE** knob) with the source channel selected might also prevent clipping. You can also select AC coupling (on TDS models so equipped) in the vertical menu of the *source* waveform or otherwise DC filter it before applying it to the oscilloscope input.

Zoom

Once you have your waveform optimally displayed, you may magnify (or reduce) it vertically and horizontally to inspect any feature you desire. Just be sure the integrated waveform is the selected waveform. (Press **MORE**, then select the integrated waveform in the More main menu. Then use the Vertical and Horizontal **SCALE** knobs to adjust the math waveform size.)

If you wish to see the zoom factor (2X, 5X, etc.) you need to turn Zoom on: press **ZOOM → On** (side). The vertical and horizontal zoom factors appear on screen.

Whether Zoom is on or off, you can press **Reset Zoom Factors** (side) to return the zoomed integral waveform to no magnification.

For More Information

See *Waveform Differentiation*, on page 3-139.

See *Fast Fourier Transforms*, on page 3-36.

See *Waveform Math*, on page 3-148.

Waveform Math

You can mathematically manipulate your waveforms. For example, you might have a waveform clouded by background noise. You can obtain a cleaner waveform by subtracting the background noise from your original waveform.

This section describes the invert, add, subtract, divide, and multiply waveform math features. If your oscilloscope is equipped with Advanced DSP Math (optional on TDS 620A & TDS 640A), see *Fast Fourier Transforms* on page 3-36, *Waveform Differentiation* on page 3-139, and *Waveform Integration* on page 3-143.

Operation

To perform waveform math, press the **MORE** button to bring up the More menu (Figure 3-79). The More menu allows you to display, define, and manipulate three math functions.

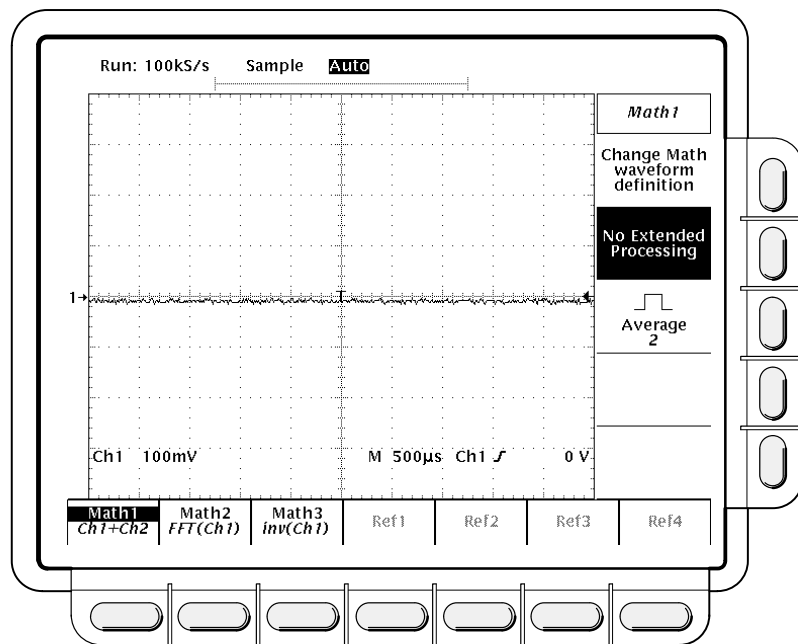

Figure 3-79: More Menu

Math1, Math2, and Math3

1. Press **MORE** → **Math1**, **Math2**, or **Math3** (main) to select the waveform that you want to display or change.

NOTE

If your digitizing oscilloscope is equipped with Advanced DSP Math (optional on TDS 620A & TDS 640A), the menu item **FFT** will be at the same brightness as the menu items **Single Wfm Math** and **Dual Wfm Math**; otherwise, **FFT** will be dimmed. See pages 3-36, 3-139, and 3-143 for information on FFTs and other advanced math waveforms.

2. Press **Average (side)** and enter a value with the general purpose knob or the keypad to take an average of multiple acquisitions. Press **No Extended Processing (side)** to perform math operations only on one acquisition.
3. If desired, turn on or turn off math averaging. To turn on math averaging, press **Average (side)** and turn the general purpose knob (or use the keypad) to enter the number of times to successively average the math waveform before completing an acquisition. Press **No Extended Processing (side)** to turn off math averaging.
4. Press **Change Math waveform definition (side)** → **FFT** (if your oscilloscope contains Advanced DSP Math), **Single Wfm Math**, or **Dual Wfm Math (main)** to alter the present math waveform definition (see Figure 3-80).

The single and dual waveform operations are described separately in the following topics. For descriptions of Advanced DSP Math, see *Fast Fourier Transforms* on page 3-36, *Waveform Differentiation* on page 3-139, and *Waveform Integration* on 3-143.

Single Wfm Math

1. Press **MORE** → **Math1**, **Math2**, or **Math3 (main)** → **Change Math waveform definition (side)** → **Single Wfm Math (main)**. Press **Set Function to (side)** to select **inv** (invert), **intg** (if your oscilloscope contains Advanced DSP Math), or **diff** (if your oscilloscope contains Advanced DSP Math). Waveform integration (intg) is described on page 3-143, and waveform differentiation (diff) is described on page 3-139.
2. To define the source waveform, press **Set Single Source to (side)**.
3. When you are ready to perform the function, press **OK Create Math Wfm (side)**.

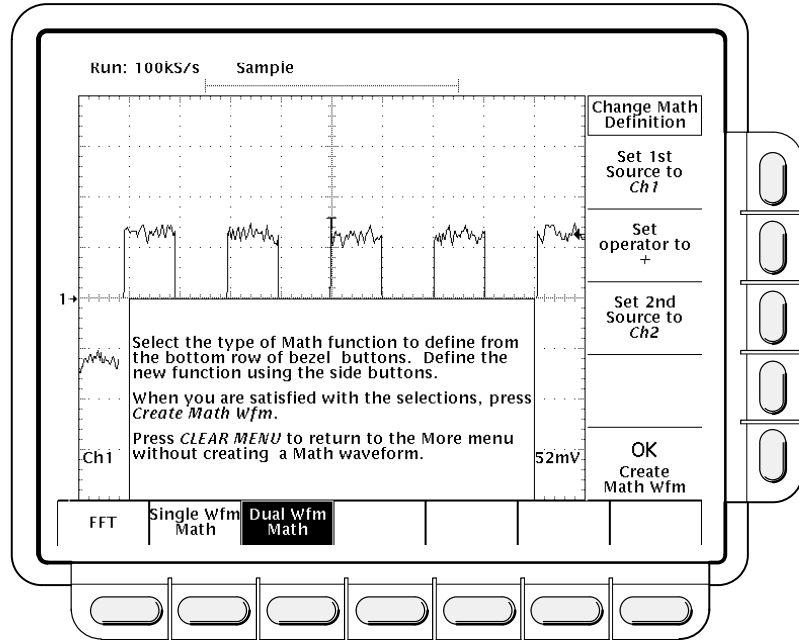

Figure 3-80: Dual Waveform Math Main and Side Menus

Dual Wfm Math

1. Select the sources with **MORE** → **Math1**, **Math2**, or **Math3** (main) → **Change Math waveform definition** (side) → **Dual Wfm Math** (main) → **Set 1st Source to** and **Set 2nd Source to** (side). Enter the sources by repeatedly pressing the appropriate channel selection button.
2. To enter the math operator, press **Set operator to** (side) to cycle through the choices. Supported operators are +, −, * and /.
3. Press **OK Create Math Wfm** (side) to perform the function.

NOTE

*If you select *, for multiply, in step 2, the cursor feature will measure amplitude in the units volts squared **VV** rather than in volts **V**.*

For More Information

If your oscilloscope is equipped with Advanced DSP Math, you can also create integrated, differentiated, and Fast Fourier Transform waveforms. See *Fast Fourier Transforms* on page 3-36, *Waveform Integration* on page 3-139, and *Waveform Differentiation* on page 3-143.

Zoom

At times, you may want to expand or compress a waveform on the display without changing the acquisition parameters. You can do that with the zoom feature.

Zoom and Interpolation

When you zoom in on a waveform on the display, you expand a portion of the waveform. The digitizing oscilloscope may need to show more points for that portion than it has acquired. If it needs to do this, it interpolates. The instrument can interpolate in either of two ways: *linear* or *sin(x)/x*. (The interpolation methods are described on page 2-20.)

When you zoom, the display redraws the waveforms using the interpolation method you selected in the Display menu (linear interpolation or *sin(x)/x*). If you selected *sin(x)/x* (the default), it may introduce some overshoot or undershoot to the waveform edges. If that happens, change the interpolation method to linear, following the instructions on page 3-152.

To differentiate between the real and interpolated samples, set the display style to **Intensified Samples**.

Operation

When you turn on the zoom feature, the vertical and horizontal scale and vertical position knobs now control the displayed size and position of waveforms, allowing them to be expanded and repositioned on screen. They cease to affect waveform acquisition, but you can alter acquisition by using the corresponding menu items. Zoom mode does not change the way horizontal position operates.

To use zoom, do the following steps:

1. Press **ZOOM → ON** (side). The **ZOOM** front-panel button should light up.
2. Choose which waveforms to zoom by repeatedly pressing **Horizontal Lock** (side).
 - **None** — only the waveform currently selected can be magnified and positioned horizontally (Figure 3-81).
 - **Live** — all channels (including **AUX** channels for the TDS 620A) can be magnified and positioned horizontally at the same time. (Waveforms displayed from an input channel are live; math and reference waveforms are not live.)
 - **All** — all waveforms displayed (channels, math, and/or reference) can be magnified and positioned horizontally at the same time.

NOTE

Although zoom must be turned on to control which waveforms zoom affects, the setting for **Horizontal Lock** affects which waveforms the horizontal control positions whether zoom is on or off. The rules for the three settings are listed in step 2.

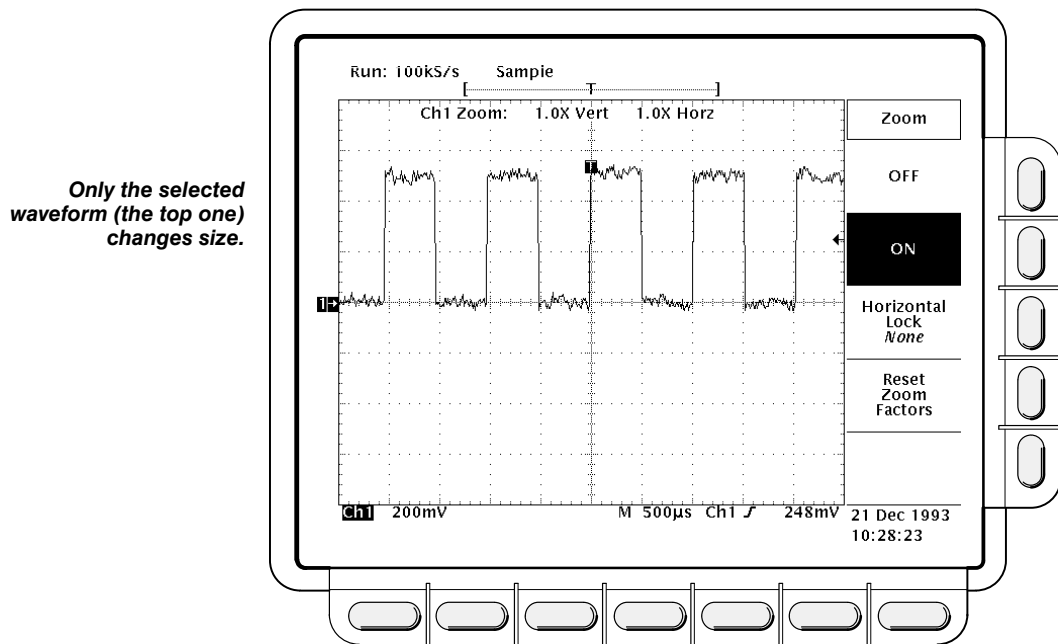

Figure 3-81: Zoom Mode with Horizontal Lock Set to None

Setting Interpolation

To change the interpolation method used:

Press **DISPLAY** → **Filter** (main) → **Sin(x)/x Interpolation** or **Linear Interpolation** (side).

Reset Zoom

To reset all zoom factors to their defaults (see Table 3-9), press **ZOOM → Reset Zoom Factors** (side).

Table 3-9: Zoom Defaults

Parameter	Setting
Zoom Vertical Position	0
Zoom Vertical Gain	1X
Zoom Horizontal Position	Tracking Horizontal Position
Zoom Horizontal Gain	1X

Press **ZOOM → Off** (side) to return to normal oscilloscope (non-zoom) operation.

For Further Information

See *Acquisition*, on page 2-19.

See *Display Modes*, on page 3-26.

Zoom

Appendix A: Options and Accessories

This section describes the options, the standard accessories, and the optional accessories that are available for the TDS 600A Digitizing Oscilloscopes.

Options

The following options are available:

Options A1 – A5: International Power Cords

Besides the standard North American, 110 V, 60 Hz power cord, Tektronix ships any of five alternate power cord configurations with the oscilloscope when ordered by the customer.

Table A-1: International Power Cords

Option	Power Cord
A1	Universal European — 220 V, 50 Hz
A2	UK — 240 V, 50 Hz
A3	Australian — 240 V, 50 Hz
A4	North American — 240 V, 60 Hz
A5	Switzerland — 220 V, 50 Hz

Option 1K: K420 Scope Cart

With this option, Tektronix ships the K420 Scope Cart. The cart can help you transport the oscilloscope around many lab environments.

Service Assurance Options

The standard warranty appears following the title page in this manual. The following options add to the services available with the standard warranty:

- **Option R2:** When Option R2 is ordered, Tektronix provides two years of post-warranty repair protection.
- **Option C5:** When Option C5 is ordered, Tektronix provides five years of calibration services.
- **Option M2:** When Option M2 is ordered, Tektronix provides five years of warranty/remedial service.

Option 1F: File System (Standard on TDS 644A)

With this option, Tektronix ships the digitizing oscilloscope with a floppy disk drive and a variety of features for managing the floppy disk. With the file system you can save and recall setups, waveforms, and hardcopies on a floppy disk.

Option 1R: Rackmounted Digitizing Oscilloscope

Tektronix ships the digitizing oscilloscope, when ordered with Option 1R, configured for installation in a 19 inch wide instrument rack. Customers with instruments not configured for rackmounting can order a rackmount kit (016-1136-00 for field conversions).

Instructions for rackmounting the digitizing oscilloscope are shipped with the Option 1R.

Option 13: RS-232/Centronics Hardcopy Interface (Standard on TDS 644A)

With this option, Tektronix ships the oscilloscope equipped with a RS-232 and a Centronics interface that can be used to obtain hardcopies of the oscilloscope screen.

Option 2D: Delete Two Probes (TDS 620A only)

With this option, Tektronix ships the instrument without the two probes normally included as standard accessories.

Option 4D: Delete Four Probes (TDS 640A & 644A only)

With this option, Tektronix ships the instrument without the four probes normally included as standard accessories.

Option 05: Video Trigger

With this option, Tektronix ships the instrument with tools for investigating events that occur when a video signal generates a horizontal or vertical sync pulse. It allows you to investigate a range of NTSC, PAL, SECAM, and high-definition TV signals.

Option 2F: Advanced DSP Math (Standard on TDS 644A)

With this option, the oscilloscope can compute and display three advanced math waveforms: integral of a waveform, differential of a waveform, and an FFT (Fast Fourier Transform) of a waveform.

Option 23: Additional Probes — (TDS 620A only)

With this option, Tektronix ships two additional probes identical to the two standard-accessory P6205 probes normally shipped with the instrument. This provides one probe for each front-panel input.

Option 24: Add Four Passive Probes

With this option, Tektronix ships four passive 10X P6139A probes.

Option 95: Calibration Data Report

With this option, Tektronix ships a calibration data report with the instrument.

Option 96: Calibration Certificate

With this option, Tektronix ships a Certificate of Calibration. This certificate states the instrument meets or exceeds all warranted specifications and has been calibrated using standards and instruments whose accuracies are traceable to the National Institute of Standards and Technology, an accepted value of a natural physical constant, or a ratio-calibration technique. The calibration is in compliance with US MIL-STD-45662A. This option includes a test data report for the oscilloscope.

**Standard
Accessories**

The following standard accessories are included with the digitizing oscilloscope:

Table A-2: Standard Accessories

Accessory	Part Number
User Manual	070-8715-XX
Programmer Manual	070-8709-XX
Reference	070-8711-XX
Performance Verification	070-8717-XX
Front Cover	200-3696-00
U.S. Power Cord	161-0230-01
Probes, TDS 640A, TDS 644A (quantity four), 10X Passive; 500 MHz	P6139A
TDS 620A (quantity two), 10X Active; 750 MHz	P6205 (single unit)

Optional Accessories

You can also order the following optional accessories:

Table A-3: Optional Accessories

Accessory	Part Number
Service Manual	070-8718-XX
Plotter (GPIB and Centronics Standard)	HC100
Oscilloscope Cart	K218
Rack Mount Kit (for field conversion)	016-1136-00
Oscilloscope Camera	C9
Oscilloscope Camera Adapter	016-1154-00
Soft-Sided Carrying Case	016-0909-01
Transit Case	016-1135-00
GPIB Cable (1 meter)	012-0991-01
GPIB Cable (2 meter)	012-0991-00

Accessory Probes

The following optional accessory probes are recommended for use with your digitizing oscilloscope:

- P6101A 1X, 15 MHz, Passive probe.
- P6156 10X, 3.5 GHz, Passive, low capacitance, (low impedance Z_0) probe.
- P6205 10X, 750 MHz, Active probe
- P6009 Passive, high voltage probe, 100X, 1500 VDC + Peak AC.
- P6015A Passive high voltage probe, 1000X, 20 kVDC + Peak AC (40 kV peak for less than 100 ms).
- P6204 Active, high speed digital voltage probe. FET. DC to 1 GHz. DC offset. 50 Ω input. Use with 1103 TekProbe Power Supply for offset control.
- P6563AS Passive, SMD probe, 20X, 500 MHz
- P6046 Active, differential probe, 1X/10X, DC to 100 MHz, 50 Ω input.
- A6501 Buffer Amplifier (active fixtured), 1 GHz, 1 M Ω , 10X.
- P6501 Option 02: Microprobe with TekProbe power cable (active fixtured), 750 MHz, 1 M Ω , 10X.
- AM 503S — DC/AC Current probe system, AC/DC. Uses A6302 Current Probe.

- AM 503S Option 03: DC/AC Current probe system, AC/DC. Uses A6303 Current Probe.
- P6021 AC Current probe. 120 Hz to 60 MHz.
- P6022 AC Current probe. 935 kHz to 120 MHz.
- CT-1 Current probe — designed for permanent or semi permanent in-circuit installation. 25 kHz to 1 GHz, 50 Ω input.
- CT-2 Current probe — designed for permanent or semi permanent in-circuit installation. 1.2 kHz to 200 MHz, 50 Ω input.
- CT-4 Current Transformer — for use with the AM 503S (A6302) and P6021. Peak pulse 1 kA. 0.5 Hz to 20 MHz with AM 503S (A6302).
- P6701A Opto-Electronic Converter, 500 to 950 nm, DC to 850 MHz, 1 V/mW.
- P6703A Opto-Electronic Converter, 1100 to 1700 nm, DC to 1 GHz, 1 V/mW.
- P6711 Opto-Electronic Converter, 500 to 950 nm, DC to 250 MHz, 5 V/mW.
- P6713 Opto-Electronic Converter, 1100 to 1700 nm, DC to 300 MHz, 5 V/mW.
- TVC 501 Time-to-voltage converter. Time delay, pulse width and period measurements.

Accessory Software

The following optional accessories are Tektronix software products recommended for use with your digitizing oscilloscope:

Table A-4: Accessory Software

Software	Part Number
EZ-Test Program Generator	S45F030
Wavewriter: AWG and waveform creation	S3FT400
TekTMS: Test management system	S3FT001
LabWindows	S3FG910

Warranty Information

Check for the full warranty statements for this product, the probes, and the products listed above on the first page after the title page of each product manual.

Appendix B: Algorithms

TDS 600A Digitizing Oscilloscopes can take 25 automatic measurements. By knowing how they make these calculations, you may better understand how to use your TDS 600A and how to interpret your results.

Measurement Variables

TDS 600A Digitizing Oscilloscopes use a variety of variables in their calculations. These include:

High, Low

High is the value used as the 100% level in measurements such as fall time and rise time. For example, if you request the 10% to 90% rise time, then the oscilloscope will calculate 10% and 90% as percentages with *High* representing 100%.

Low is the value used as the 0% level in measurements such as fall time and rise time.

The exact meaning of *High* and *Low* depends on which of two calculation methods you choose from the **High-Low Setup** item of the Measure menu. These are *Min-max* and *Histogram*.

Min-Max Method — defines the 0% and the 100% waveform levels as the lowest amplitude (most negative) and the highest amplitude (most positive) samples. The min-max method is useful for measuring frequency, width, and period for many types of signals. Min-max is sensitive to waveform ringing and spikes, however, and does not always measure accurately rise time, fall time, overshoot, and undershoot.

The min-max method calculates the High and Low values as follows:

$$High = Max$$

and

$$Low = Min$$

Histogram Method — attempts to find the highest density of points above and below the waveform midpoint. It attempts to ignore ringing and spikes when determining the 0% and 100% levels. This method works well when measuring square waves and pulse waveforms.

The oscilloscope calculates the histogram-based *High* and *Low* values as follows:

1. It makes a histogram of the record with one bin for each digitizing level (256 total).

2. It splits the histogram into two sections at the halfway point between *Min* and *Max* (also called *Mid*).
3. The level with the most points in the upper histogram is the *High* value, and the level with the most points in the lower histogram is the *Low* value. (Choose the levels where the histograms peak for *High* and *Low*.)

If *Mid* gives the largest peak value within the upper or lower histogram, then return the *Mid* value for both *High* and *Low* (this is probably a very low amplitude waveform).

If more than one histogram level (bin) has the maximum value, choose the bin farthest from *Mid*.

This algorithm does not work well for two-level waveforms with greater than about 100% overshoot.

HighRef, MidRef, LowRef, Mid2Ref

The user sets the various reference levels, through the **Reference Level** selection of the Measure menu. They include:

HighRef — the waveform high reference level. Used in fall time and rise time calculations. Typically set to 90%. You can set it from 0% to 100% or to a voltage level.

MidRef — the waveform middle reference level. Typically set to 50%. You can set it from 0% to 100% or to a voltage level.

LowRef — the waveform low reference level. Used in fall and rise time calculations. Typically set to 10%. You can set it from 0% to 100% or to a voltage level.

Mid2Ref — the middle reference level for a second waveform (or the second middle reference of the same waveform). Used in delay time calculations. Typically set to 50%. You can set it from 0% to 100% or to a voltage level.

Other Variables

The oscilloscope also measures several values itself that it uses to help calculate measurements.

RecordLength — is the number of data points in the time base. You set it with the Horizontal menu **Record Length** item.

Start — is the location of the start of the measurement zone (X-value). It is 0.0 samples unless you are making a gated measurement. When you use gated measurements, it is the location of the left vertical cursor.

End — is the location of the end of the measurement zone (X-value). It is $(RecordLength - 1.0)$ samples unless you are making a gated measurement. When you use gated measurements, it is the location of the right vertical cursor.

Hysteresis — The hysteresis band is 10% of the waveform amplitude. It is used in *MCross1*, *MCross2*, and *MCross3* calculations.

For example, once a crossing has been measured in a negative direction, the waveform data must fall below 10% of the amplitude from the *MidRef* point before the measurement system is armed and ready for a positive crossing. Similarly, after a positive *MidRef* crossing, waveform data must go above 10% of the amplitude before a negative crossing can be measured. Hysteresis is useful when you are measuring noisy signals, because it allows the digitizing oscilloscope to ignore minor fluctuations in the signal.

MCross Calculations

MCross1, MCross2, and MCross3 — refer to the first, second, and third *MidRef* cross times, respectively. See Figure A-1.

The polarity of the crossings does not matter for these variables, but the crossings alternate in polarity; that is, *MCross1* could be a positive or negative crossing, but if *MCross1* is a positive crossing, *MCross2* will be a negative crossing.

The oscilloscope calculates these values as follows:

1. Find the first *MidRefCrossing* in the waveform record or the gated region. This is *MCross1*.
2. Continuing from *MCross1*, find the next *MidRefCrossing* in the waveform record (or the gated region) of the opposite polarity of *MCross1*. This is *MCross2*.
3. Continuing from *MCross2*, find the next *MidRefCrossing* in the waveform record (or the gated region) of the same polarity as *MCross1*. This is *MCross3*.

MCross1Polarity — is the polarity of first crossing (no default). It can be rising or falling.

StartCycle — is the starting time for cycle measurements. It is a floating-point number with values between 0.0 and $(RecordLength - 1.0)$, inclusive.

$$StartCycle = MCross1$$

EndCycle — is the ending time for cycle measurements. It is a floating-point number with values between 0.0 and $(RecordLength - 1.0)$, inclusive.

$$EndCycle = MCross3$$

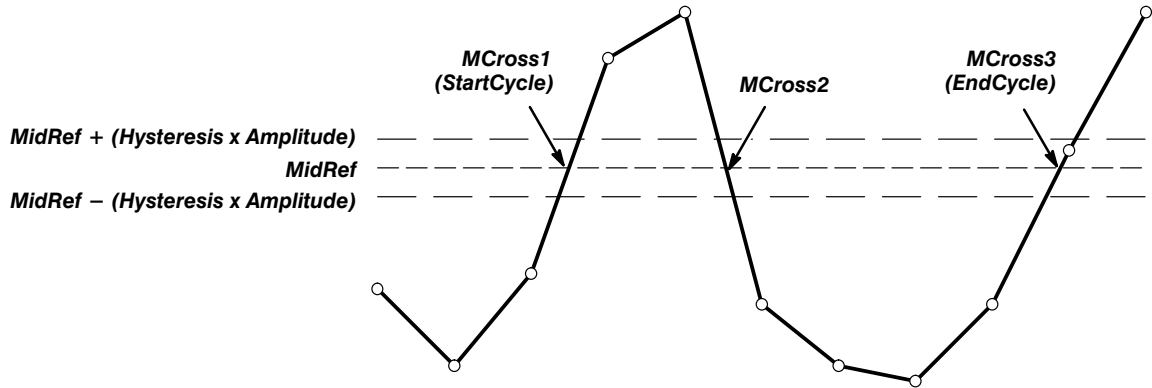

Figure A-1: MCross Calculations

Waveform[<0.0 ... RecordLength-1.0>] — holds the acquired data.

TPOS — is the location of the sample just before the trigger point (the time reference zero sample). In other terms, it contains the domain reference location. This location is where time = 0.

TSOFF — is the offset between *TPOS* and the actual trigger point. In other words, it is the trigger sample offset. Values range between 0.0 and 1.0 samples. This value is determined by the instrument when it receives a trigger. The actual zero reference (trigger) location in the measurement record is at (*TPOS*+*TSOFF*).

Measurement Algorithms



The automated measurements are defined and calculated as follows.

Amplitude

$$Amplitude = High - Low$$



Area

The arithmetic area for one waveform. Remember that one waveform is not necessarily equal to one cycle. For cyclical data you may prefer to use the cycle area rather than the arithmetic area.

if *Start* = *End* then return the (interpolated) value at *Start*.

Otherwise,

$$Area = \int_{Start}^{End} Waveform(t)dt$$

For details of the integration algorithm, see page A-17.

Cycle Area



Amplitude (voltage) measurement. The area over one waveform cycle. For non-cyclical data, you might prefer to use the Area measurement.

If $StartCycle = EndCycle$ then return the (interpolated) value at $StartCycle$.

$$CycleMean = \int_{StartCycle}^{EndCycle} Waveform(t) dt$$

For details of the integration algorithm, see page A-17.

Burst Width



Timing measurement. The duration of a burst.

1. Find $MCross1$ on the waveform. This is $MCrossStart$.
2. Find the last $MCross$ (begin the search at $EndCycle$ and search toward $StartCycle$). This is $MCrossStop$. This could be a different value from $MCross1$.
3. Compute $BurstWidth = MCrossStop - MCrossStart$

Cycle Mean



Amplitude (voltage) measurement. The mean over one waveform cycle. For non-cyclical data, you might prefer to use the Mean measurement.

If $StartCycle = EndCycle$ then return the (interpolated) value at $StartCycle$.

$$CycleMean = \frac{\int_{StartCycle}^{EndCycle} Waveform(t) dt}{(EndCycle - StartCycle) \times SampleInterval}$$

For details of the integration algorithm, see page A-17.

Cycle RMS



The true Root Mean Square voltage over one cycle.

If $StartCycle = EndCycle$ then $CycleRMS = Waveform[Start]$.

Otherwise,

$$CycleRMS = \sqrt{\frac{\int_{StartCycle}^{EndCycle} (Waveform(t))^2 dt}{(EndCycle - StartCycle) \times SampleInterval}}$$

For details of the integration algorithm, see page A-17.

Delay



Timing measurement. The amount of time between the *MidRef* and *Mid2Ref* crossings of two different traces, or two different places on the same trace.

Delay measurements are actually a group of measurements. To get a specific delay measurement, you must specify the target and reference crossing polarities and the reference search direction.

Delay = the time from one *MidRef* crossing on the source waveform to the *Mid2Ref* crossing on the second waveform.

Delay is not available in the Snapshot display.

Fall Time



Timing measurement. The time taken for the falling edge of a pulse to drop from a *HighRef* value (default = 90%) to a *LowRef* value (default = 10%).

Figure A-2 shows a falling edge with the two crossings necessary to calculate a Fall measurement.

1. Searching from *Start* to *End*, find the first sample in the measurement zone greater than *HighRef*.
2. From this sample, continue the search to find the first (negative) crossing of *HighRef*. The time of this crossing is *THF*. (Use linear interpolation if necessary.)
3. From *THF*, continue the search, looking for a crossing of *LowRef*. Update *THF* if subsequent *HighRef* crossings are found. When a *LowRef* crossing is found, it becomes *TLF*. (Use linear interpolation if necessary.)
4. $FallTime = TLF - THF$

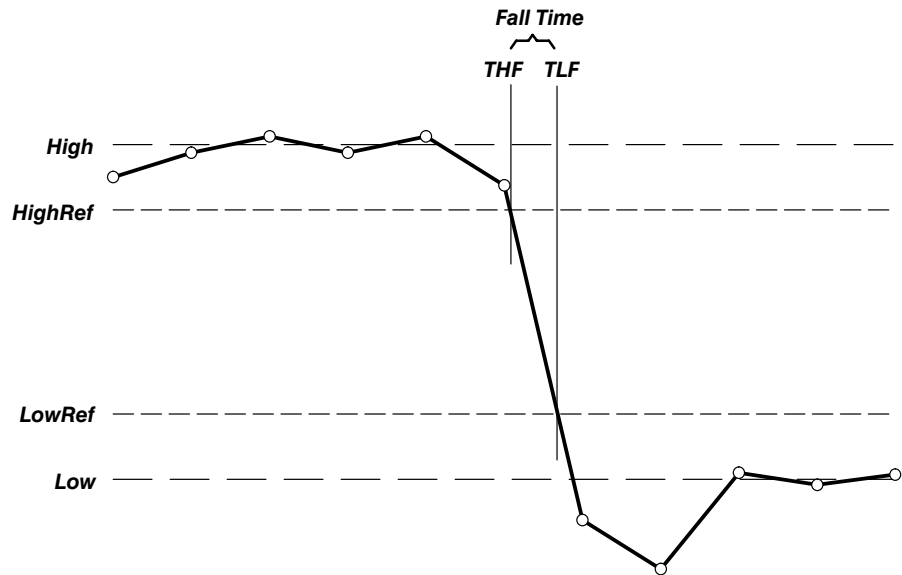

Figure A-2: Fall Time

Frequency



Timing measurement. The reciprocal of the period. Measured in Hertz (Hz) where 1 Hz = 1 cycle per second.

If *Period* = 0 or is otherwise bad, return an error.

$$\text{Frequency} = 1/\text{Period}$$

High



100% (highest) voltage reference value. (See “High, Low” earlier in this section)

Using the min-max measurement technique:

$$\text{High} = \text{Max}$$

Low



0% (lowest) voltage reference value calculated. (See “High, Low” earlier in this section)

Using the min-max measurement technique:

$$\text{Low} = \text{Min}$$

Maximum



Amplitude (voltage) measurement. The maximum voltage. Typically the most positive peak voltage.

Examine all *Waveform[]* samples from *Start* to *End* inclusive, and set *Max* equal to the greatest magnitude *Waveform[]* value found.

Mean



The arithmetic mean for one waveform. Remember that one waveform is not necessarily equal to one cycle. For cyclical data you may prefer to use the cycle mean rather than the arithmetic mean.

If *Start = End* then return the (interpolated) value at *Start*.

Otherwise,

$$Mean = \frac{\int_{Start}^{End} Waveform(t) dt}{(End - Start) \times SampleInterval}$$

For details of the integration algorithm, see page A-17.

Minimum



Amplitude (voltage) measurement. The minimum amplitude. Typically the most negative peak voltage.

Examine all *Waveform[]* samples from *Start* to *End* inclusive, and set *Min* equal to the smallest magnitude *Waveform[]* value found.

Negative Duty Cycle



Timing measurement. The ratio of the negative pulse width to the signal period expressed as a percentage.

NegativeWidth is defined in **Negative Width**, below.

If *Period = 0* or undefined then return an error.

$$NegativeDutyCycle = \frac{NegativeWidth}{Period} \times 100\%$$

Negative Overshoot



Amplitude (voltage) measurement.

$$NegativeOvershoot = \frac{Low - Min}{Amplitude} \times 100\%$$

Note that this value should never be negative (unless High or Low are set out-of-range).

Negative Width



Timing measurement. The distance (time) between *MidRef* (default = 50%) amplitude points of a negative pulse.

If *MCross1Polarity* = ‘-’

then

$$\text{NegativeWidth} = (\text{MCross2} - \text{MCross1})$$

else

$$\text{NegativeWidth} = (\text{MCross3} - \text{MCross2})$$

Peak to Peak



Amplitude measurement. The absolute difference between the maximum and minimum amplitude.

$$\text{PeaktoPeak} = \text{Max} - \text{Min}$$

Period



Timing measurement. Time taken for one complete signal cycle. The reciprocal of frequency. Measured in seconds.

$$\text{Period} = \text{MCross3} - \text{MCross1}$$

Phase



Timing measurement. The amount of phase shift, expressed in degrees of the target waveform cycle, between the *MidRef* crossings of two different waveforms. Waveforms measured should be of the same frequency or one waveform should be a harmonic of the other.

Phase is a dual waveform measurement; that is, it is measured from a target waveform to a reference waveform. To get a specific phase measurement, you must specify the target and reference sources.

Phase is determined in the following manner:

1. The first *MidRefCrossing* (*MCross1Target*) and third (*MCross3*) in the source (target) waveform are found.
2. The period of the target waveform is calculated (see “Period” above).
3. The first *MidRefCrossing* (*MCross1Ref*) in the reference waveform crossing in the same direction (polarity) as that found *MCross1Target* for the target waveform is found.
4. The phase is determined by the following:

$$\text{Phase} = \frac{\text{MCross1Ref} - \text{MCross1Target}}{\text{Period}} \times 360$$

If the target waveform leads the reference waveform, phase is positive; if it lags, negative.

Phase is not available in the Snapshot display.

Positive Duty Cycle



Timing measurement. The ratio of the positive pulse width to the signal period, expressed as a percentage.

PositiveWidth is defined in **Positive Width**, following.

If *Period* = 0 or undefined then return an error.

$$PositiveDutyCycle = \frac{PositiveWidth}{Period} \times 100\%$$

Positive Overshoot



Amplitude (voltage) measurement.

$$PositiveOvershoot = \frac{Max - High}{Amplitude} \times 100\%$$

Note that this value should never be negative.

Positive Width



Timing measurement. The distance (time) between *MidRef* (default = 50%) amplitude points of a positive pulse.

If *MCross1Polarity* = '+'

then

$$PositiveWidth = (MCross2 - MCross1)$$

else

$$PositiveWidth = (MCross3 - MCross2)$$

Rise Time



Timing measurement. Time taken for the leading edge of a pulse to rise from a *LowRef* value (default = 10%) to a *HighRef* value (default = 90%).

Figure A-3 shows a rising edge with the two crossings necessary to calculate a Rise Time measurement.

1. Searching from *Start* to *End*, find the first sample in the measurement zone less than *LowRef*.
2. From this sample, continue the search to find the first (positive) crossing of *LowRef*. The time of this crossing is the low rise time or *TLR*. (Use linear interpolation if necessary.)

3. From *TLR*, continue the search, looking for a crossing of *HighRef*. Update *TLR* if subsequent *LowRef* crossings are found. If a *HighRef* crossing is found, it becomes the high rise time or *THR*. (Use linear interpolation if necessary.)
4. $RiseTime = THR - TLR$

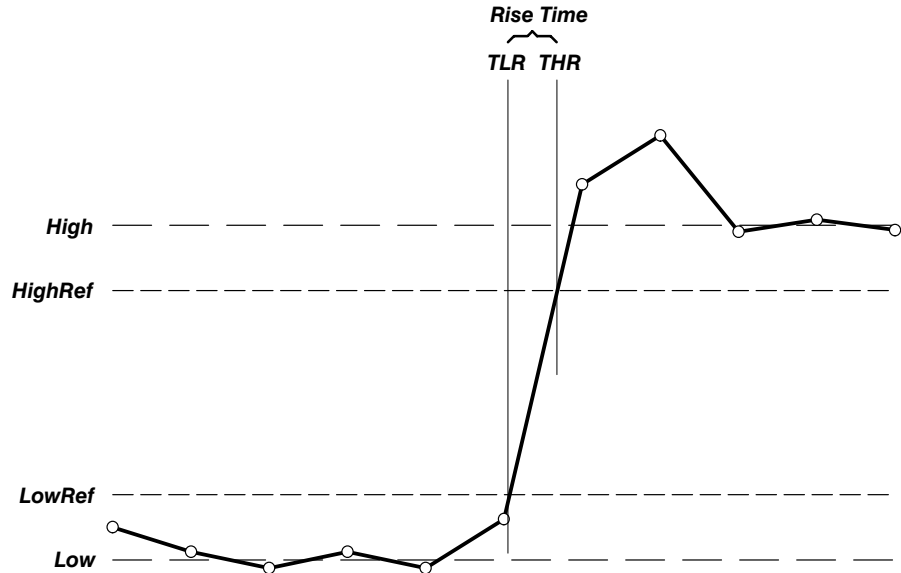

Figure A-3: Rise Time

RMS:



Amplitude (voltage) measurement. The true Root Mean Square voltage.

If $Start = End$ then $RMS =$ the (interpolated) value at $Waveform[Start]$.

Otherwise,

$$RMS = \sqrt{\frac{\int_{Start}^{End} (Waveform(t))^2 dt}{(End - Start) \times SampleInterval}}$$

For details of the integration algorithm, see below.

Integration Algorithm

The integration algorithm used by the digitizing oscilloscope is as follows:

$$\int_A^B W(t)dt \text{ is approximated by } \int_A^B \hat{W}(t)dt \text{ where:}$$

$W(t)$ is the sampled waveform

$\hat{W}(t)$ is the continuous function obtained by linear interpolation of $W(t)$

A and B are numbers between 0.0 and $RecordLength - 1.0$

If A and B are integers, then:

$$\int_A^B \hat{W}(t) dt = s \times \sum_{i=A}^{B-1} \frac{W(i) + W(i + 1)}{2}$$

where s is the sample interval.

Similarly,

$$\int_A^B (W(t))^2 dt \text{ is approximated by } \int_A^B (\hat{W}(t))^2 dt \text{ where:}$$

$W(t)$ is the sampled waveform

$\hat{W}(t)$ is the continuous function obtained by linear interpolation of $W(t)$

A and B are numbers between 0.0 and $RecordLength - 1.0$

If A and B are integers, then:

$$\int_A^B (\hat{W}(t))^2 dt = s \times \sum_{i=A}^{B-1} \frac{(W(i))^2 + W(i) \times W(i + 1) + (W(i + 1))^2}{3}$$

where s is the sample interval.

Measurements on Envelope Waveforms

Time measurements on envelope waveforms must be treated differently from time measurements on other waveforms, because envelope waveforms contain so many apparent crossings. Unless otherwise noted, envelope waveforms use either the minima or the maxima (but not both), determined in the following manner:

1. Step through the waveform from *Start* to *End* until the sample min and max pair *DO NOT* straddle *MidRef*.
2. If the pair $> MidRef$, use the minima, else use maxima.

If all pairs straddle *MidRef*, use maxima. See Figure A-4.

The Burst Width measurement always uses both maxima and minima to determine crossings.

Missing or Out-of-Range Samples

If some samples in the waveform are missing or off-scale, the measurements will linearly interpolate between known samples to make an “appropriate” guess as to the sample value. Missing samples at the ends of the measurement record will be assumed to have the value of the nearest known sample.

When samples are out of range, the measurement will give a warning to that effect (for example, “CLIPPING”) if the measurement could change by extending the measurement range slightly. The algorithms assume the samples recover from an overdrive condition instantaneously.

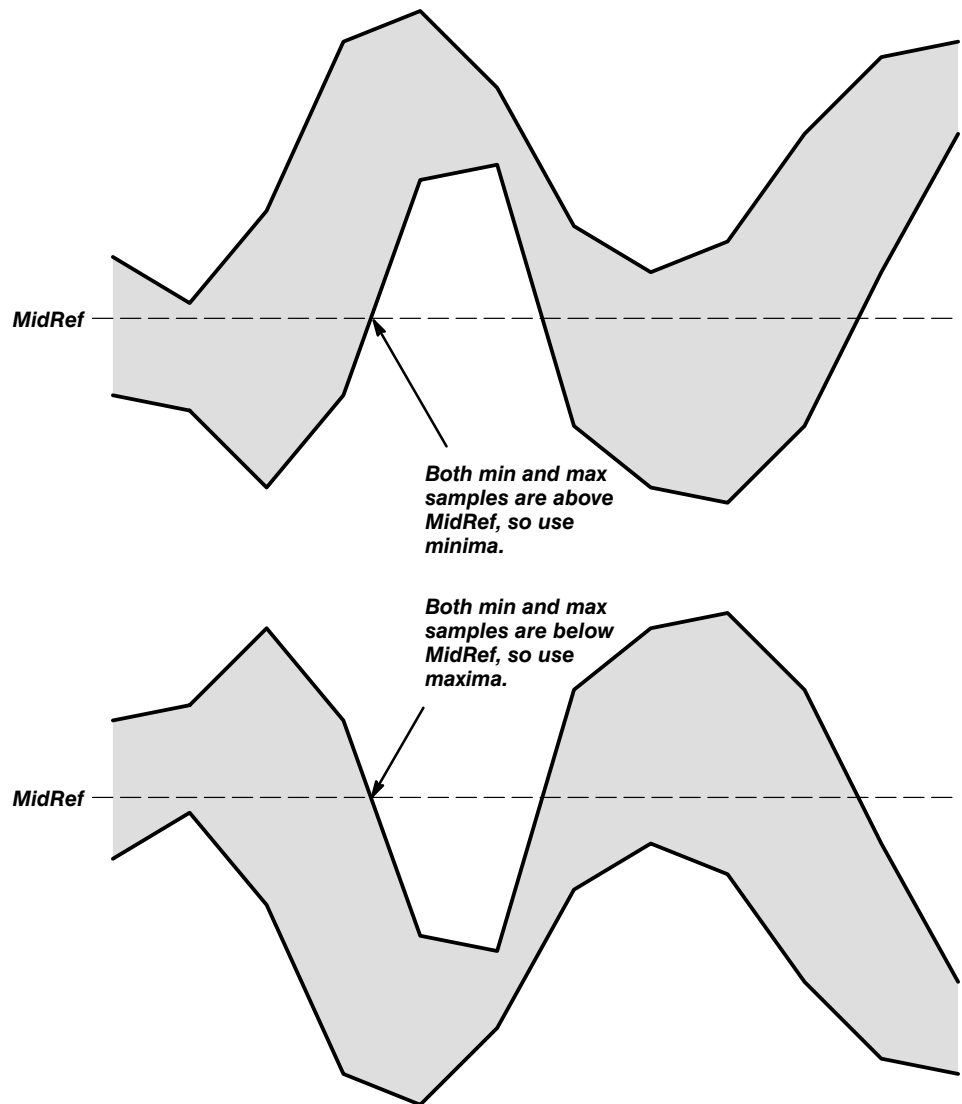

Figure A-4: Choosing Minima or Maxima to Use for Envelope Measurements

For example, if *MidRef* is set directly, then *MidRef* would not change even if samples were out of range. However, if *MidRef* was chosen using the % choice from the **Set Levels in % Units** selection of the Measure menu, then *MidRef* could give a “CLIPPING” warning.

NOTE

When measurements are displayed using Snapshot, out of range warnings are NOT available. However, if you question the validity of any measurement in the snapshot display, you can select and display the measurement individually and then check for a warning message.

Appendix C: Packaging for Shipment

If you ship the digitizing oscilloscope, pack it in the original shipping carton and packing material. If the original packing material is not available, package the instrument as follows:

1. Obtain a corrugated cardboard shipping carton with inside dimensions at least 15 cm (6 in) taller, wider, and deeper than the digitizing oscilloscope. The shipping carton must be constructed of cardboard with 170 kg (375 pound) test strength.
2. If you are shipping the digitizing oscilloscope to a Tektronix field office for repair, attach a tag to the digitizing oscilloscope showing the instrument owner and address, the name of the person to contact about the instrument, the instrument type, and the serial number.
3. Wrap the digitizing oscilloscope with polyethylene sheeting or equivalent material to protect the finish.
4. Cushion the digitizing oscilloscope in the shipping carton by tightly packing dunnage or urethane foam on all sides between the carton and the digitizing oscilloscope. Allow 7.5 cm (3 in) on all sides, top, and bottom.
5. Seal the shipping carton with shipping tape or an industrial stapler.

NOTE

Do not ship the digitizing oscilloscope with a disk inside the disk drive (optional on TDS 620A & TDS 640A). When the disk is inside the drive, the disk release button sticks out. This makes the button more prone to damage than otherwise.

Appendix C: Packaging for Shipment

Appendix D: Factory Initialization Settings

The factory initialization settings provide you a known state for the digitizing oscilloscope.

Settings

Factory initialization sets values as shown in Table A-5.

Table A-5: Factory Initialization Defaults

Control	Changed by Factory Init to
Acquire mode	Sample
Acquire stop after	RUN/STOP button only
Acquire # of averages	16
Acquire # of envelopes	10
Channel selection	Channel 1 on, all others off
Cursor H Bar 1 position	10% of graticule height (−3.2 divs from the center)
Cursor H Bar 2 position	90% of the graticule height (+3.2 divs from the center)
Cursor V Bar 1 position	10% of the record length
Cursor V Bar 2 position	90% of the record length
Cursor amplitude units	Base
Cursor mode	Independent
Cursor function	Off
Cursor time units	Seconds
Date and time	No change
Delayed edge trigger coupling	DC
Delayed edge trigger level	0 V
Delayed edge trigger slope	Rising
Delayed edge trigger source	Channel 1
Delay trigger average #	16

Table A-5: Factory Initialization Defaults (Cont.)

Control	Changed by Factory Init to
Delay trigger envelope #	10
Delay time	16 ns
Delay events, triggerable after main	2
Delayed, delay by ...	Delay by Time
Delayed, time base mode	Delayed Runs After Main
Display clock	No Change
Display color – collision contrast (TDS 644A)	Off
Display color – map math colors (TDS 644A)	Color ‘Math’
Display color – map reference colors (TDS 644A)	Color ‘Ref’
Display color – palette (TDS 644A)	Normal
Display color – palette colors (TDS 644A)	The colors of each palette are reset to factory hue, saturation, and lightness (HLS) values
Display color – persistence palette (TDS 644A)	Temperature
Display format	YT
Display graticule type	Full
Display intensity – contrast (TDS 620A & TDS 640A)	175%
Display intensity – text	TDS 620A & TDS 640A: 60% TDS 644A: 100%
Display intensity – waveform	TDS 620A & TDS 640A: 80% TDS 644A: 100%
Display intensity – overall (TDS 620A & TDS 640A)	85%
Display interpolation filter	Sin(x)/x
Display style	Vectors
Display trigger bar style	Short
Display trigger “T”	On
Display variable persistence	500 ms

Table A-5: Factory Initialization Defaults (Cont.)

Control	Changed by Factory Init to
Edge trigger coupling	DC
Edge trigger level	0.0 V
Edge trigger slope	Rising
Edge trigger source	Channel 1
GPIB parameters	No change
Hardcopy Format	Unchanged
Layout	Unchanged
Palette	Unchanged
Port	Unchanged
Horizontal – delay trigger position	50%
Horizontal – delay time/division	50 μ s
Horizontal – fit to screen	Off
Horizontal – main trigger position	50%
Horizontal – position	50%
Horizontal – record length	500 points (10 divs)
Horizontal – main time/division	500 μ s
Horizontal – time base	Main only
Limit template \pm V Limit	40 mdiv
\pm H Limit	40 mdiv
Limit template destination	Ref1
Limit template source	Ch1
Limit test sources	Ch1 compared to Ref1; all others compared to none.
Limit Testing	Off
Limit Testing – hardcopy if condition met	Off
Limit Testing – ring bell if condition met	Off
Logic pattern trigger Ch4 (Ax2) input	X (don't care)
Logic state trigger Ch4 (Ax2) input	Rising edge
Logic trigger input (pattern and state)	Channel 1 = H (high), Channels 2 & 3 (Ax1) = X (don't care)

Table A-5: Factory Initialization Defaults (Cont.)

Control	Changed by Factory Init to
Logic trigger pattern time qualification	
Lower limit	5 ns
Upper limit	5 ns
Logic trigger threshold (all channels) (pattern and state)	1.2 V
Logic trigger class	Pattern
Logic trigger logic (pattern and state)	AND
Logic trigger triggers when ... (pattern and state)	Goes TRUE
Main trigger holdoff	0%
Main trigger mode	Auto
Main trigger type	Edge
Math1 definition	Ch 1 + Ch 2
Math1 extended processing	No extended processing
Math2 definition	Ch 1 – Ch 2 (FFT of Ch 1 on instruments with Option 2F Ad- vanced DSP Math)
Math2 extended processing	No extended processing
Math3 definition	Inv of Ch 1
Math3 extended processing	No extended processing
Measure Delay to	Channel 1 (Ch1)
Measure Delay edges	Both rising and forward searching
Measure High-Low Setup	Histogram
Measure High Ref	90% and 0 V (units)
Measure Low Ref	10% and 0 V (units)
Measure Mid Ref	50% and 0 V (units)
Measure Mid2 Ref	50% and 0 V (units)
Pulse glitch trigger polarity	Positive
Pulse runt high threshold	1.2 V
Pulse runt low threshold	0.8 V
Pulse runt trigger polarity	Positive

Table A-5: Factory Initialization Defaults (Cont.)

Control	Changed by Factory Init to
Pulse trigger class	Glitch
Pulse glitch filter state	On (Accept glitch)
Pulse glitch width	2.0 ns
Pulse trigger level	0.0 V
Pulse trigger source (Glitch, runt, and width)	Channel 1 (Ch1)
Pulse width trigger when ...	Within limits
Pulse width upper limit	2.0 ns
Pulse width lower limit	2.0 ns
Pulse width trigger polarity	Positive
Repetitive signal	On
RS-232 parameters	No change
Saved setups	No change
Saved waveforms	No change
Stop after	R/S button
Vertical bandwidth (all channels)	Full
Vertical coupling (all channels)	DC
Vertical impedance (termination) (all channels)	1 M Ω
Vertical offset (all channels)	0 V
Vertical position (all channels)	0 divs.
Vertical volts/division (all channels)	100 mV/division
Zoom horizontal (all channels)	1.0X
Zoom horizontal lock	All
Zoom horizontal position (all channels)	50% = 0.5 (the middle of the display)
Zoom state	Off
Zoom vertical (all channels)	1.0X
Zoom vertical position (all channels)	0 divisions

Appendix D: Factory Initialization Settings

Glossary

AC 

AC coupling

A type of signal transmission that blocks the DC component of a signal but uses the dynamic (AC) component. Useful for observing an AC signal that is normally riding on a DC signal.

Accuracy

The closeness of the indicated value to the true value.

Acquisition

The process of sampling signals from input channels, digitizing the samples into data points, and assembling the data points into a waveform record. The waveform record is stored in memory. The trigger marks time zero in that process.

Acquisition interval

The time duration of the waveform record divided by the record length. The digitizing oscilloscope displays one data point for every acquisition interval.

Active cursor

The cursor that moves when you turn the general purpose knob. It is represented in the display by a solid line. The @ readout on the display shows the absolute value of the active cursor.

Aliasing

A false representation of a signal due to insufficient sampling of high frequencies or fast transitions. A condition that occurs when a digitizing oscilloscope digitizes at an effective sampling rate that is too slow to reproduce the input signal. The waveform displayed on the oscilloscope may have a lower frequency than the actual input signal.



Amplitude

The High waveform value less the Low waveform value.



AND

A logic (Boolean) function in which the output is true when and only when all the inputs are true. On the digitizing oscilloscope, that is a trigger logic pattern and state function.



Area

Measurement of the waveform area taken over the entire waveform or the gated region. Expressed in volt-seconds. Area above ground is positive; area below ground is negative.

Attenuation

The degree the amplitude of a signal is reduced when it passes through an attenuating device such as a probe or attenuator. That is, the ratio of the input measure to the output measure. For example, a 10X probe will attenuate, or reduce, the input voltage of a signal by a factor of 10.

Automatic trigger mode

A trigger mode that causes the oscilloscope to automatically acquire if triggerable events are not detected within a specified time period.

Autoset

A function of the oscilloscope that automatically produces a stable waveform of usable size. Autoset sets up front-panel controls based on the characteristics of the active waveform. A successful autoset will set the volts/div, time/div, and trigger level to produce a coherent and stable waveform display.



Average acquisition mode

In this mode the oscilloscope acquires and displays a waveform that is the averaged result of several acquisitions. Averaging reduces the apparent noise. The oscilloscope acquires data as in the sample mode and then averages it according to a specified number of averages.



Bandwidth

The highest frequency signal the oscilloscope can acquire with no more than 3 dB ($\times .707$) attenuation of the original (reference) signal.



Burst width

A timing measurement of the duration of a burst.

Channel

One type of input used for signal acquisition. The TDS 644A & TDS 640A have four channels; the TDS 620A has two.

Channel Reference Indicator

The indicator on the left side of the display that points to the position around which the waveform contracts or expands when vertical scale is changed. This position is ground when offset is set to 0 V; otherwise, it is ground plus offset.

Coupling

The association of two or more circuits or systems in such a way that power or information can be transferred from one to the other. You can couple the input signal to the trigger and vertical systems several different ways.

Cursors

Paired markers that you can use to make measurements between two waveform locations. The oscilloscope displays the values (expressed in volts or time) of the position of the active cursor and the distance between the two cursors.

**Cycle area**

A measurement of waveform area taken over one cycle. Expressed in volt-seconds. Area above ground is positive; area below ground is negative.

**Cycle mean**

An amplitude (voltage) measurement of the arithmetic mean over one cycle.

**Cycle RMS**

The true Root Mean Square voltage over one cycle.

DC

**DC coupling**

A mode that passes both AC and DC signal components to the circuit. Available for both the trigger system and the vertical system.

Delay measurement

A measurement of the time between the middle reference crossings of two different waveforms.

Delay time

The time between the trigger event and the acquisition of data.

Digitizing

The process of converting a continuous analog signal such as a waveform to a set of discrete numbers representing the amplitude of the signal at specific points in time. Digitizing is composed of two steps: sampling and quantizing.

Display system

The part of the oscilloscope that shows waveforms, measurements, menu items, status, and other parameters.

Edge Trigger

Triggering occurs when the oscilloscope detects the source passing through a specified voltage level in a specified direction (the trigger slope).

**Envelope acquisition mode**

A mode in which the oscilloscope acquires and displays a waveform that shows the variation extremes of several acquisitions.

**Fall time**

A measurement of the time it takes for trailing edge of a pulse to fall from a HighRef value (typically 90%) to a LowRef value (typically 10%) of its amplitude.

**Frequency**

A timing measurement that is the reciprocal of the period. Measured in Hertz (Hz) where 1 Hz = 1 cycle per second.

Gated Measurements

A feature that lets you limit automated measurements to a specified portion of the waveform. You define the area of interest using the vertical cursors.



General purpose knob

The large front-panel knob with an indentation. You can use it to change the value of the assigned parameter.



Glitch positive trigger

Triggering occurs if the oscilloscope detects positive spike widths less than the specified glitch time.



Glitch negative trigger

Triggering occurs if the oscilloscope detects negative spike widths less than the specified glitch time.



Glitch either trigger

Triggering occurs if the oscilloscope detects either positive or negative spike widths less than the specified glitch time.



GPIB (General Purpose Interface Bus)

An interconnection bus and protocol that allows you to connect multiple instruments in a network under the control of a controller. Also known as IEEE 488 bus. It transfers data with eight parallel data lines, five control lines, and three handshake lines.



Graticule

A grid on the display screen that creates the horizontal and vertical axes. You can use it to visually measure waveform parameters.



Ground (GND) coupling

Coupling option that disconnects the input signal from the vertical system.



Hardcopy

An electronic copy of the display in a format useable by a printer or plotter.



High

The value used as 100% in automated measurements (whenever high ref, mid ref, and low ref values are needed as in fall time and rise time measurements). May be calculated using either the min/max or the histogram method. With the min/max method (most useful for general waveforms), it is the maximum value found. With the histogram method (most useful for pulses), it refers to the most common value found above the mid point. See *Appendix B: Algorithms* for details.

Holdoff, trigger

A specified amount of time after a trigger signal that elapses before the trigger circuit will accept another trigger signal. Trigger holdoff helps ensure a stable display.



Horizontal bar cursors

The two horizontal bars that you position to measure the voltage parameters of a waveform. The oscilloscope displays the value of the active (moveable) cursor with respect to ground and the voltage value between the bars.

Interpolation

The way the digitizing oscilloscope calculates values for record points when the oscilloscope cannot acquire all the points for a complete record with a single trigger event. That condition occurs when the oscilloscope is limited to real time sampling and the time base is set to a value that exceeds the effective sample rate of the oscilloscope. The digitizing oscilloscope has two interpolation options: *linear* or *sin(x)/x interpolation*.

Linear interpolation calculates record points in a straight-line fit between the actual values acquired. Sin(x)/x computes record points in a curve fit between the actual values acquired. It assumes all the interpolated points fall in their appropriate point in time on that curve.

Intensity

Display brightness.

Knob

A rotary control.

**Logic state trigger**

The oscilloscope checks for defined combinatorial logic conditions on channels 1, 2, and 3 on a transition of channel 4 that meets the set slope and threshold conditions. If the conditions of channels 1, 2, and 3 are met then the oscilloscope triggers.

**Logic pattern trigger**

The oscilloscope triggers depending on the combinatorial logic condition of channels 1, 2, 3, and 4. Allowable conditions are AND, OR, NAND, and NOR.

**Low**

The value used as 0% in automated measurements (whenever high ref, mid ref, and low ref values are needed as in fall time and rise time measurements). May be calculated using either the min/max or the histogram method. With the min/max method (most useful for general waveforms), it is the minimum value found. With the histogram method (most useful for pulses), it refers to the most common value found below the mid point. See *Appendix B: Algorithms* for details.

Main menu

A group of related controls for a major oscilloscope function that the oscilloscope displays across the bottom of the screen.

Main menu buttons

Bezel buttons under the main menu display. They allow you to select items in the main menu.

**Maximum**

Amplitude (voltage) measurement of the maximum amplitude. Typically the most positive peak voltage.

**Mean**

Amplitude (voltage) measurement of the arithmetic mean over the entire waveform.

**Minimum**

Amplitude (voltage) measurement of the minimum amplitude. Typically the most negative peak voltage.

**NAND**

A logic (Boolean) function in which the output of the AND function is complemented (true becomes false, and false becomes true). On the digitizing oscilloscope, that is a trigger logic pattern and state function.

**Negative duty cycle**

A timing measurement representing the ratio of the negative pulse width to the signal period, expressed as a percentage.

**Negative overshoot measurement**

Amplitude (voltage) measurement.

$$\text{NegativeOvershoot} = \frac{\text{Low} - \text{Min}}{\text{Amplitude}} \times 100\%$$

**Negative width**

A timing measurement of the distance (time) between two amplitude points — falling-edge *MidRef* (default 50%) and rising-edge *MidRef* (default 50%) — on a negative pulse.

Normal trigger mode

A mode on which the oscilloscope does not acquire a waveform record unless a valid trigger event occurs. It waits for a valid trigger event before acquiring waveform data.

**NOR**

A logic (Boolean) function in which the output of the OR function is complemented (true becomes false, and false becomes true). On the digitizing oscilloscope, that is a trigger logic pattern and state function.

**OR**

A logic (Boolean) function in which the output is true if any of the inputs are true. Otherwise the output is false. On the digitizing oscilloscope, that is a trigger logic pattern and state function.

Oscilloscope

An instrument for making a graph of two factors. These are typically voltage versus time.

**Peak-to-Peak**

Amplitude (voltage) measurement of the absolute difference between the maximum and minimum amplitude.

**Period**

A timing measurement of the time covered by one complete signal cycle. It is the reciprocal of frequency and is measured in seconds.



Phase

A timing measurement between two waveforms of the amount one leads or lags the other in time. Phase is expressed in degrees, where 360° comprise one complete cycle of one of the waveforms. Waveforms measured should be of the same frequency or one waveform should be a harmonic of the other.

Pixel

A visible point on the display. The oscilloscope display is 640 pixels wide by 480 pixels high.

Pop-up Menu

A sub-menu of a main menu. Pop-up menus temporarily occupy part of the waveform display area and are used to present additional choices associated with the main menu selection. You can cycle through the options in a pop-up menu by repeatedly pressing the main menu button underneath the pop-up.



Positive duty cycle

A timing measurement of the ratio of the positive pulse width to the signal period, expressed as a percentage.



Positive overshoot

Amplitude (voltage) measurement.

$$\text{PositiveOvershoot} = \frac{\text{Max} - \text{High}}{\text{Amplitude}} \times 100\%$$



Positive width

A timing measurement of the distance (time) between two amplitude points — rising-edge *MidRef* (default 50%) and falling-edge *MidRef* (default 50%) — on a positive pulse.

Posttrigger

The specified portion of the waveform record that contains data acquired after the trigger event.

Pretrigger

The specified portion of the waveform record that contains data acquired before the trigger event.

Probe

An oscilloscope input device.

Quantizing

The process of converting an analog input that has been sampled, such as a voltage, to a digital value.

Probe compensation

Adjustment that improves low-frequency response of a probe.

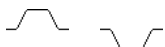

Pulse trigger

A trigger mode in which triggering occurs if the oscilloscope finds a pulse, of the specified polarity, with a width between, or optionally outside, the user-specified lower and upper time limits.

Real-time sampling

A sampling mode where the digitizing oscilloscope samples fast enough to completely fill a waveform record from a single trigger event. Use real-time sampling to capture single-shot or transient events. (All TDS 600A series oscilloscopes use real time sampling at all acquisition rates.)

Record length

The specified number of samples in a waveform.

Reference memory

Memory in a oscilloscope used to store waveforms or settings. You can use that waveform data later for processing. The digitizing oscilloscope saves the data even when the oscilloscope is turned off or unplugged.

**Rise time**

The time it takes for a leading edge of a pulse to rise from a *LowRef* value (typically 10%) to a *HighRef* value (typically 90%) of its amplitude.

**RMS**

Amplitude (voltage) measurement of the true Root Mean Square voltage.

Runt trigger

A mode in which the oscilloscope triggers on a runt. A runt is a pulse that crosses one threshold but fails to cross a second threshold before recrossing the first. The crossings detected can be positive, negative, or either.

**Sample acquisition mode**

The oscilloscope creates a record point by saving the first sample during each acquisition interval. That is the default mode of the acquisition.

Sample interval

The time interval between successive samples in a time base. For real-time digitizers, the sample interval is the reciprocal of the sample rate. For equivalent-time digitizers, the time interval between successive samples represents equivalent time, not real time.

Sampling

The process of capturing an analog input, such as a voltage, at a discrete point in time and holding it constant so that it can be quantized. Two general methods of sampling are: *real-time sampling* and *equivalent-time sampling*.

Select button

A button that changes which of the two cursors is active.

Selected waveform

The waveform on which all measurements are performed, and which is affected by vertical position and scale adjustments. The light over one of the channel selector buttons indicates the current selected waveform.

Side menu

Menu that appears to the right of the display. These selections expand on main menu selections.

Side menu buttons

Bezel buttons to the right of the side menu display. They allow you to select items in the side menu.

Slope

The direction at a point on a waveform. You can calculate the direction by computing the sign of the ratio of change in the vertical quantity (Y) to the change in the horizontal quantity. The two values are rising and falling.

Tek Secure

This feature erases all waveform and setup memory locations (setup memories are replaced with the factory setup). Then it checks each location to verify erasure. This feature finds use where this *digitizing oscilloscope* is used to gather security sensitive data, such as is done for research or development projects.

Time base

The set of parameters that let you define the time and horizontal axis attributes of a waveform record. The time base determines when and how long to acquire record points.

Trigger

An event that marks time zero in the waveform record. It results in acquisition and display of the waveform.

**Trigger level**

The vertical level the trigger signal must cross to generate a trigger (on edge trigger mode).

**Vertical bar cursors**

The two vertical bars you position to measure the time parameter of a waveform record. The oscilloscope displays the value of the active (moveable) cursor with respect to the trigger and the time value between the bars.

Waveform

The shape or form (visible representation) of a signal.

Waveform interval

The time interval between record points as displayed.

**XY format**

A display format that compares the voltage level of two waveform records point by point. It is useful for studying phase relationships between two waveforms.

**YT format**

The conventional oscilloscope display format. It shows the voltage of a waveform record (on the vertical axis) as it varies over time (on the horizontal axis).

Numbers

- 1/seconds (Hz), Cursor menu, 3-19
- 100 MHz, Vertical menu, 3-138
- 20 MHz, Vertical menu, 3-138

A

- AC coupling, 2-16–2-17, *Glossary-1*
- AC line voltage, trigger input, 2-14
- AC**, Main Trigger menu, 3-33
- Accept Glitch**, Main Trigger menu, 3-112
- Accessories, A-1–A-6
 - Optional, A-4
 - Probes, A-4–A-6
 - Software, A-5–A-6
 - Standard, A-3, A-5
- Accuracy, *Glossary-1*
- Acquire menu, 3-5, 3-70
 - Average**, 3-5
 - Average** mode, 3-71
 - Compare Ch1 to**, 3-72
 - Compare Ch2 to**, 3-72
 - Compare Ch3 to**, 3-72
 - Compare Ch4 to**, 3-72
 - Compare Math1 to**, 3-72
 - Compare Math2 to**, 3-72
 - Compare Math3 to**, 3-72
 - Create Limit Test Template**, 3-70
 - Envelope**, 3-5
 - H Limit**, 3-71
 - Hardcopy if Condition Met**, 3-73
 - Limit Test**, 3-73
 - Limit Test Condition Met**, 3-73
 - Limit Test Setup**, 3-72, 3-73
 - Limit Test Sources**, 3-72
 - Mode**, 3-5
 - OK Store Template**, 3-71
 - Ring Bell if Condition Met**, 3-73
 - RUN/STOP**, 3-6
 - Sample**, 3-5
 - Single Acquisition Sequence**, 3-7
 - Stop After**, 3-6, 3-73

- Stop After Limit Test Condition Met**, 3-73
- Template Source**, 3-70
- V Limit**, 3-71
- ACQUIRE MENU** button, 3-5, 3-70
- Acquisition, 2-19–2-21, 3-8, *Glossary-1*
 - Interval, *Glossary-1*
 - Modes
 - Average, 3-5
 - Envelope, 3-4
 - Sample, 3-3
 - Readout, 3-5
- Active cursor, *Glossary-1*
- Active voltage probes, 3-104–3-105
- active**, Saved waveform status, 3-123
- Algorithms, A-7–A-20
- Aliasing, 2-24, 3-46, *Glossary-1*
- Amplitude, 3-83, *Glossary-1*
- Amplitude Units**, Cursor menu, 3-19
- AND, *Glossary-1*
- AND**, Main Trigger menu, 3-79, 3-82
- Applications
 - derivative math waveforms, 3-139
 - FFT math waveforms, 3-36
 - integral math waveforms, 3-143
- Area, 3-83, *Glossary-1*
- Attenuation, *Glossary-2*
- Auto**, Main Trigger menu, 3-35, 3-79, 3-111
- Automated Measurements, Snapshot of, 1-22
- Automated measurements, 1-18, 2-26, 3-83
 - of derivative math waveforms, 3-140
 - (procedure), 3-140
 - of FFT math waveforms, 3-41
 - of integral math waveforms, 3-146
- Automatic trigger mode, 2-15, *Glossary-2*
- Autosave**, Save/Recall Waveform menu, 3-125
- Autoset, 1-11, 2-25, 3-8–3-9, *Glossary-2*

- AUTOSET** button, 1-12, 3-8, 3-128
- AUX TRIGGER INPUT**, BNC, 2-5
- Auxiliary trigger, 2-14
- Average acquisition mode, 3-5, *Glossary-2*
- Average** mode, Acquire menu, 3-71
- Average**, Acquire menu, 3-5
- Average**, More menu, 3-149

B

- Bandwidth, 1-1, 2-21, *Glossary-2*
- Bandwidth**, Vertical menu, 3-138
- Base**, Cursor menu, 3-19
- Baud Rate**, Utility menu, 3-58
- Blackman-Harris window, 3-39
- BMP, 3-57
- BMP Color**, Hardcopy menu, 3-59
- BMP Mono**, Hardcopy menu, 3-59
- BNC
 - AUX TRIGGER INPUT**, 2-5
 - DELAYED TRIGGER OUTPUT**, 2-5
 - MAIN TRIGGER OUTPUT**, 2-5
 - SIGNAL OUTPUT**, 2-5
- Bold**, Color menu, 3-11
- Burst width, 3-83
- Button
 - ACQUIRE MENU**, 3-5, 3-70
 - AUTOSET**, 1-12, 2-24, 3-8, 3-128
 - CLEAR MENU**, 1-10, 1-19, 1-20, 2-3, 2-8, 3-92
 - CURSOR**, 2-27, 3-17
 - DELAYED TRIG**, 2-18, 3-23
 - DISPLAY**, 3-10, 3-26
 - FORCE TRIG**, 3-133
 - HARDCOPY**, 3-53, 3-59, 3-118
 - HELP**, 3-65
 - HORIZONTAL MENU**, 2-18, 3-21
 - MEASURE**, 3-86
 - MORE**, 3-124, 3-126, 3-148
 - ON/STBY**, 1-5, 2-3

Index

- Save/Recall **SETUP**, 1-8, 3-53, 3-120
 - Save/Recall **WAVEFORM**, 3-53, 3-123
 - SELECT**, 2-27, 3-18, *Glossary-8*
 - SET LEVEL TO 50%**, 3-133
 - SINGLE TRIG**, 3-7, 3-133
 - STATUS**, 3-130
 - TOGGLE**, 3-18
 - TRIGGER MENU**, 3-32, 3-77, 3-111, 3-113, 3-135
 - UTILITY**, 3-58, 3-118
 - VERTICAL MENU**, 1-15
 - WAVEFORM OFF**, 1-17, 3-30, 3-127
 - ZOOM**, 2-25, 3-151
- Buttons
- CH1, CH2 ...**, 3-126
 - Channel selection, 1-14, 3-126
 - Main menu, 2-3
 - Side menu, 2-3
-
- ## C
- Cables, 3-117, 3-118
 - Cal Probe**, Vertical menu, 3-94
 - Calibration Certificate, A-3
 - Calibration Data Report, A-3
 - Cart, Oscilloscope, A-1
 - CAUTION**
 - statement in manuals, *xi*
 - statement on equipment, *xi*
 - Centronics, 2-5
 - Port**, 3-59
 - CH1, CH2 ...** buttons, 3-126
 - Ch1, Ch2 ...**, Delayed Trigger menu, 3-24
 - Ch1, Ch2 ...**, Main Trigger menu, 3-32, 3-78, 3-79, 3-81, 3-111, 3-113
 - Change Colors**, Color menu, 3-11
 - Change Math waveform definition**, More menu, 3-149
 - Channel, 3-126–3-127, *Glossary-2*
 - Readout, 2-6, 3-126
 - Reference Indicator, 2-6
 - Selection buttons, 1-14, 3-126
 - Trigger input, 2-13–2-18
 - Channel readout, 2-6
 - Channel reference indicator, *Glossary-2*
 - Circuit loading, *Glossary-2*
 - Class**, Main Trigger menu, 3-77, 3-111, 3-113
 - CLEAR MENU** button, 1-10, 1-19, 1-20, 2-3, 2-8, 3-92
 - Clear Spool**, Hardcopy menu, 3-60
 - Clipping
 - derivative math waveforms, 3-141
 - FFT math waveforms, 3-44
 - how to avoid, 3-44, 3-141, 3-146
 - integral math waveforms, 3-146
 - Collision Contrast**, Color menu, 3-14
 - Color, 3-10–3-14
 - Color Matches Contents**, Color menu, 3-13
 - Color menu, 3-10
 - Bold**, 3-11
 - Change Colors**, 3-11
 - Collision Contrast**, 3-14
 - Color**, 3-12, 3-13
 - Color Matches Contents**, 3-13
 - Hardcopy**, 3-11
 - Hue**, 3-12
 - Lightness**, 3-12
 - Map Math**, 3-12
 - Map Reference**, 3-13
 - Math**, 3-12
 - Monochrome**, 3-11
 - Normal**, 3-11
 - Options**, 3-14
 - Palette**, 3-11
 - Persistence Palette**, 3-11
 - Ref**, 3-13
 - Reset All Mappings To Factory**, 3-14
 - Reset All Palettes To Factory**, 3-14
 - Reset Current Palette To Factory**, 3-14
 - Reset to Factory Color**, 3-12
 - Restore Colors**, 3-14
 - Saturation**, 3-12
 - Spectral**, 3-11
 - Temperature**, 3-11
 - View Palette**, 3-11
 - Color**, Color menu, 3-12, 3-13
 - Color**, Display menu, 3-10
 - Compare Ch1 to**, Acquire menu, 3-72
 - Compare Ch2 to**, Acquire menu, 3-72
 - Compare Ch3 to**, Acquire menu, 3-72
 - Compare Ch4 to**, Acquire menu, 3-72
 - Compare Math1 to**, Acquire menu, 3-72
 - Compare Math2 to**, Acquire menu, 3-72
 - Compare Math3 to**, Acquire menu, 3-72
 - Compensation, 3-100
 - Configure**, Utility menu, 3-58, 3-118
 - Confirm Delete**, File Utilities menu, 3-56
 - Connector
 - AUX TRIGGER INPUT**, 2-5
 - Centronics, 2-5
 - DELAYED TRIGGER OUTPUT**, 2-5
 - GPIO, 2-5, 3-117
 - MAIN TRIGGER OUTPUT**, 2-5
 - Power, 2-5
 - RS-232, 2-5
 - SIGNAL OUTPUT**, 2-5
 - VGA, 2-5
 - Contrast**, Display menu, 3-27
 - Conventions, ii
 - Copy**, File Utilities menu, 3-55
 - Coupling, 1-15
 - AC, 2-16
 - DC, 2-16
 - Ground, *Glossary-4*
 - Input Signal, 2-21
 - Trigger, 2-16
 - Coupling**, Delayed Trigger menu, 3-24
 - Coupling**, Main Trigger menu, 3-33
 - Coupling**, Vertical menu, 3-137
 - Create Directory**, File Utilities menu, 3-55
 - Create Limit Test Template**, Acquire menu, 3-70
 - Create Measrmt**, Measure Delay menu, 3-92
 - Cross Hair**, Display menu, 3-29
 - Current probes, 3-105
 - Cursor
 - Horizontal bar, 2-27, 3-15
 - Measurements, 2-27

- Mode, 2-27–2-28
 - Independent, 2-27–2-28
 - Tracking, 2-28
 - Paired, 2-27, 3-15
 - Vertical bar, 2-27, 3-15
 - CURSOR** button, 3-17
 - Cursor menu, 3-17, 3-40, 3-144
 - 1/seconds (Hz), 3-19
 - Amplitude Units, 3-19
 - Base, 3-19
 - Function, 3-17, 3-18
 - H Bars, 3-17, 3-18
 - Independent, 3-18
 - IRE (NTSC), 3-19
 - seconds, 3-19
 - Time Units, 3-19
 - Tracking, 3-18
 - Video Line Number, 3-19
 - Cursor readout
 - H-Bars, 3-40, 3-141, 3-145
 - Paired, 3-141
 - Paired cursors, 3-41, 3-145
 - V-Bars, 3-40, 3-141, 3-145
 - Cursor Readouts, 3-16
 - Cursor Speed, 3-19
 - Cursors, 2-27, 3-15–3-19, *Glossary-2*
 - with derivative waveforms, 3-141
 - with FFT waveforms, 3-40
 - with integral waveforms, 3-144
 - Cycle area, 3-83, *Glossary-3*
 - Cycle mean, 3-83, *Glossary-3*
 - Cycle RMS, 3-83, *Glossary-3*
-
- D**
- DANGER, statement on equipment, *xi*
 - Date/Time
 - On hardcopies, 3-60
 - To set, 3-60
 - DC coupling, 2-16, *Glossary-3*
 - DC offset, 3-44
 - for DC correction of FFTs, 3-44
 - with math waveforms, 3-44, 3-146
 - DC**, Main Trigger menu, 3-33
 - Define Inputs**, Main Trigger menu, 3-79, 3-81
 - Define Logic**, Main Trigger menu, 3-79, 3-82
 - Delay by Events**, Delayed Trigger menu, 3-23
 - Delay by Time**, Delayed Trigger menu, 3-23
 - Delay by**, Delayed Trigger menu, 3-23
 - Delay measurement, 3-90, *Glossary-3*
 - Delay time, *Glossary-3*
 - Delay To**, Measure Delay menu, 3-90
 - Delayed Only**, Horizontal menu, 3-21
 - Delayed Runs After Main, 2-18
 - Delayed Runs After Main**, Horizontal menu, 3-21, 3-68
 - Delayed Scale**, Horizontal menu, 3-68
 - DELAYED TRIG** button, 2-18, 3-23
 - Delayed trigger, 2-18, 3-20–3-25
 - Delayed Trigger menu, 3-23–3-25
 - Ch1, Ch2 ..., 3-24
 - Coupling, 3-24
 - Delay by, 3-23
 - Delay by Events, 3-23
 - Delay by Time, 3-23
 - Falling edge, 3-24
 - Level, 3-24
 - Rising edge, 3-24
 - Set to 50%, 3-25
 - Set to ECL, 3-24
 - Set to TTL, 3-24
 - Slope, 3-24
 - Source, 3-24
 - DELAYED TRIGGER OUTPUT**, BNC, 2-5
 - Delayed Triggerable, 2-18
 - Delayed Triggerable**, Horizontal menu, 3-23, 3-68
 - Delete Refs**, Save/Recall Waveform menu, 3-124
 - Delete**, File Utilities menu, 3-54
 - Derivative math waveform, 3-139
 - applications, 3-139
 - derivation of, 3-139
 - procedure for displaying, 3-139
 - procedure for measuring, 3-140, 3-141
 - record length of, 3-139
 - Deskjet, 3-57
 - Deskjet**, Hardcopy menu, 3-59
 - Differential active probes, 3-104
 - Differentiation
 - of a derivative, 3-139
 - waveform, 3-139
 - Digitizing, *Glossary-3*
 - Digitizing rate, 1-1
 - Disk drive, 3-53–3-56
 - Display, 2-6, 3-8
 - Options, 3-26–3-31
 - Record View, 3-134
 - System, *Glossary-3*
 - Display 'T' @ Trigger Point**, Display menu, 3-28
 - DISPLAY** button, 3-10, 3-10, 3-26
 - Display menu, 3-10, 3-26
 - Color, 3-10
 - Contrast, 3-27
 - Cross Hair, 3-29
 - Display, 3-26
 - Display 'T' @ Trigger Point, 3-28
 - Dots, 3-27
 - Dots style, 3-72
 - Filter, 3-29
 - Format, 3-30
 - Frame, 3-29
 - Full, 3-29
 - Graticule, 3-29
 - Grid, 3-29
 - Infinite Persistence, 3-27
 - Intensified Samples, 3-27
 - Intensity, 3-27
 - Linear interpolation, 3-29
 - NTSC, 3-29
 - Overall, 3-27
 - PAL, 3-29
 - Readout, 3-28
 - Settings, 3-10, 3-26
 - Sin(x)/x interpolation, 3-29
 - Style, 3-26
 - Text/Grat, 3-27
 - Trigger Bar, 3-28
 - Variable Persistence, 3-27
 - Vectors, 3-27
 - Waveform, 3-27
 - XY, 3-30
 - YT, 3-30
 - Display**, Display menu, 3-26
 - Display**, Status menu, 3-130
 - Dots, 3-27
 - Dots** style, Display menu, 3-72

Index

Dots, Display menu, 3-27
DPU411 – II, Hardcopy menu, 3-59
DPU412, Hardcopy menu, 3-59
Dual Wfm Math, More menu, 3-149
Duty cycle, 1-19, *Glossary-6*, *Glossary-7*

E

Edge trigger, 2-14, 3-32, *Glossary-3*
Readout, 3-32, 3-76
Edge, Main Trigger menu, 3-32, 3-135
Edges, Measure Delay menu, 3-91
Either, Main Trigger menu, 3-112, 3-113
empty, Saved waveform status, 3-123
Encapsulated Postscript, 3-57
Enter Char, Labelling menu, 3-54, 3-55
Envelope acquisition mode, 3-4, *Glossary-3*
Envelope, Acquire menu, 3-5
EPS Color Img, Hardcopy menu, 3-59
EPS Color Plt, Hardcopy menu, 3-59
EPS Mono Img, Hardcopy menu, 3-59
EPS Mono Plt, Hardcopy menu, 3-59
Epson, 3-57
Epson, Hardcopy menu, 3-59

F

Factory initialization settings, A-23–A-28
factory, Saved setup status, 3-120
Fall time, 3-84, *Glossary-3*
Falling edge, Delayed Trigger menu, 3-24
Falling edge, Main Trigger menu, 3-34, 3-81
Fast Fourier Transforms, description, 3-36

Fast Fourier Transforms (FFTs), applications, 3-36
FastFrame interactions, 3-17
FFT frequency domain record, 3-42
defined, 3-42–3-52
length of, 3-43
FFT math waveform, 3-36
acquisition mode, 3-45
aliasing, 3-46
automated measurements of, 3-41
DC correction, 3-44
derivation of, 3-36
displaying phase, 3-38
frequency range, 3-43
frequency resolution, 3-43
interpolation mode, 3-45, 3-46
magnifying, 3-45
phase display, setup considerations, 3-47–3-52
phase suppression, 3-39, 3-48
procedure for displaying, 3-37
procedure for measuring, 3-40
record length, 3-43
reducing noise, 3-45
undersampling, 3-46
zero phase reference, 3-47
FFT time domain record, defined, 3-42
File System, 3-53–3-56
Optional File System, A-2
File Utilities menu, 3-53
Confirm Delete, 3-56
Copy, 3-55
Create Directory, 3-55
Delete, 3-54
File Utilities, 3-53
Format, 3-56
Overwrite Lock, 3-56
Print, 3-55
Rename, 3-54
File Utilities, File Utilities menu, 3-53
File Utilities, Save/Recall Setup menu, 3-122
File Utilities, Save/Recall Waveform menu, 3-125
Filter, Display menu, 3-29
Fine Scale, Vertical menu, 3-138
Firmware version, 3-130
Fit to screen, Horizontal menu, 3-68
Fixtured active probes, 3-104
FORCE TRIG button, 3-133

Format, Display menu, 3-30
Format, File Utilities menu, 3-56
Format, Hardcopy menu, 3-59
Frame, Display menu, 3-29
Frequency, 1-19, 3-84, *Glossary-3*
Front Cover removal, 1-5
Front panel, 2-4
Full, Display menu, 3-29
Full, Vertical menu, 3-138
Function, Cursor menu, 3-17, 3-18
Fuse, 1-4, 2-5

G

Gated Measurements, 3-88, *Glossary-3*
Gating, Measure menu, 3-88
General purpose (high input resistance) probes, 3-102
General purpose knob, 1-20, 2-7, *Glossary-4*
Glitch trigger, 3-109, 3-110, *Glossary-4*
Glitch, Main Trigger menu, 3-111, 3-112
Goes FALSE, Main Trigger menu, 3-78
Goes TRUE, Main Trigger menu, 3-78
GPIO, 2-5, 3-116–3-119, *Glossary-4*
GPIO, Hardcopy menu, 3-59
GPIO, Utility menu, 3-58, 3-118
Graticule, 3-29, *Glossary-4*
Measurements, 2-28
Graticule, Display menu, 3-29
Grid, Display menu, 3-29
Ground coupling, *Glossary-4*

H

H Bars, Cursor menu, 3-17, 3-18
H Limit, Acquire menu, 3-71

- Hamming window, 3-39
- Hanning window, 3-39
- Hard Flagging**, Utility menu, 3-58
- Hardcopy, 3-57–3-64, *Glossary-4*
- Hardcopy (Talk Only)**, Utility menu, 3-58
- HARDCOPY** button, 3-53, 3-59, 3-118
- Hardcopy if Condition Met**, Acquire menu, 3-73
- Hardcopy Interface, Optional RS-232/Centronic, A-2
- Hardcopy menu
- BMP Color**, 3-59
 - BMP Mono**, 3-59
 - Clear Spool**, 3-59, 3-60
 - Deskjet**, 3-59
 - DPU411–II**, 3-59
 - DPU412**, 3-59
 - EPS Color Img**, 3-59
 - EPS Color Plt**, 3-59
 - EPS Mono Img**, 3-59
 - EPS Mono Plt**, 3-59
 - Epson**, 3-59
 - Format**, 3-59
 - GPIB**, 3-59
 - HPGL**, 3-59
 - Interleaf**, 3-59
 - Landscape**, 3-59
 - Laserjet**, 3-59
 - Layout**, 3-59
 - OK Confirm Clear Spool**, 3-60
 - PCX**, 3-59
 - PCX Color**, 3-59
 - Port**, 3-59
 - Portrait**, 3-59
 - RLE Color**, 3-59
 - Thinkjet**, 3-59
 - TIFF**, 3-59
- Hardcopy**, Color menu, 3-11
- Hardcopy**, Utility menu, 3-118
- Hardware Setup**, Utility menu, 3-58
- HC100 Plotter, 3-57
- HC220 Printer, 3-57
- HELP** button, 3-65
- Help system, 3-65
- HF Rej**, Main Trigger menu, 3-33
- High, 3-84, *Glossary-4*
- High frequency rejection, 2-16
- High Ref**, Measure menu, 3-90
- High speed active probes, 3-104
- High voltage probes, 3-103–3-104
- High-Low Setup**, Measure menu, 3-89
- Histogram**, Measure menu, 3-89
- Holdoff**, Main Trigger menu, 3-79, 3-111
- Holdoff, trigger, 2-15, *Glossary-4*
- Horiz Pos**, Horizontal menu, 3-68
- Horiz Scale**, Horizontal menu, 3-68
- Horizontal, 3-8
- Bar cursors, 2-27, 3-15, *Glossary-4*
 - Control, 3-66–3-69
 - Menu, 2-18
 - Position, 3-66
 - POSITION** knob, 2-23
 - Readouts, 3-67
 - Scale, 3-66
 - SCALE** knob, 1-11, 2-23
 - System, 1-11, 2-23
- Horizontal menu, 3-21
- Delayed Only**, 3-21
 - Delayed Runs After Main**, 3-21, 3-68
 - Delayed Scale**, 3-68
 - Delayed Triggerable**, 3-23, 3-68
 - Fit to screen**, 3-68
 - Horiz Pos**, 3-68
 - Horiz Scale**, 3-68
 - Intensified**, 3-21, 3-23
 - Main Scale**, 3-68
 - Record Length**, 3-68
 - Set to 10%**, 3-68
 - Set to 50%**, 3-68
 - Set to 90%**, 3-68
 - Time Base**, 3-21, 3-67
 - Trigger Position**, 3-68
- HORIZONTAL MENU** button, 2-18, 3-21
- Horizontal **POSITION** knob, 3-66
- Horizontal Readouts, 3-67
- Horizontal **SCALE** knob, 3-66
- HPGL, 3-57
- HPGL**, Hardcopy menu, 3-59
- Hue**, Color menu, 3-12
-
- I/O**, Status menu, 3-130
- I/O**, Utility menu, 3-58, 3-118
- Icons, 1-1
- Independent Mode, Cursor, 2-27–2-28
- Independent**, Cursor menu, 3-18
- Infinite Persistence**, Display menu, 3-27
- Installation, 1-3–1-4
- Integral math waveform, 3-143
- applications, 3-143
 - automated measurements of, 3-146
 - derivation of, 3-143
 - magnifying, 3-142, 3-147
 - procedure for displaying, 3-143
 - procedure for measuring, 3-144
 - record length of, 3-143
- Integration, Waveform, 3-143
- Intensified Samples**, Display menu, 3-27
- Intensified**, Horizontal menu, 3-21, 3-23
- Intensity, 3-27, *Glossary-5*
- Intensity**, Display menu, 3-27
- Interleaf, 3-57
- Interleaf**, Hardcopy menu, 3-59
- Interpolation, 2-20, 3-6, 3-29, *Glossary-5*
- FFT distortion, 3-46
 - linear versus $\sin(x)/x$, 3-46
- IRE (NTSC)**, Cursor menu, 3-19
-
- ## K
- Keypad, 1-21
- Knob, *Glossary-5*
- General purpose, 1-20, 2-7, *Glossary-4*
 - Horizontal **POSITION**, 1-11, 2-23, 3-66

Index

Horizontal **SCALE**, 1-11, 2-23, 3-66
MEASURE, 2-26
Trigger **MAIN LEVEL**, 1-12, 2-17
Vertical **POSITION**, 1-11, 2-23,
3-136
Vertical **SCALE**, 1-11, 2-23, 3-136

L

Labelling menu, **Enter Char**, 3-54,
3-55
Landscape, Hardcopy menu, 3-59
Laserjet, 3-57
Laserjet, Hardcopy menu, 3-59
Layout, Hardcopy menu, 3-59
Level, Delayed Trigger menu, 3-24
Level, Main Trigger menu, 3-34,
3-112, 3-115
Level, Trigger, 2-17
LF Rej, Main Trigger menu, 3-33
Lightness, Color menu, 3-12
Limit Test Condition Met, Acquire
menu, 3-73
Limit Test Setup, Acquire menu, 3-72,
3-73
Limit Test Sources, Acquire menu,
3-72
Limit Test, Acquire menu, 3-73
Limit testing, 3-70–3-74
Linear interpolation, 2-20, 3-29, *Glos-
sary-5*
Linear interpolation, Display menu,
3-29
Logic trigger, 2-14, 3-77
Definitions, 3-77
Pattern, 3-76, *Glossary-5*
State, 3-76, *Glossary-5*
Logic triggering, 3-75–3-82
Logic, Main Trigger menu, 3-135
Low, 3-84, *Glossary-5*
Low frequency rejection, 2-16
Low impedance Z_0 probes, 3-102
Low Ref, Measure menu, 3-90

M

Main menu, *Glossary-5*
Main menu buttons, 2-3, *Glossary-5*
Main Scale, Horizontal menu, 3-68
Main Trigger Menu
Falling edge, 3-34
Rising edge, 3-34
Main Trigger menu, 2-10, 3-32, 3-77,
3-111, 3-113, 3-135
AC, 3-33
Accept Glitch, 3-112
AND, 3-79, 3-82
Auto, 3-35, 3-79, 3-111
Ch1, Ch2 ..., 3-32, 3-78, 3-79, 3-81,
3-111, 3-113
Class, 3-77, 3-111, 3-113
Coupling, 3-33
DC, 3-33
Define Inputs, 3-79, 3-81
Define Logic, 3-79, 3-82
Edge, 3-32, 3-135
Either, 3-112, 3-113
Falling edge, 3-81
Glitch, 3-111, 3-112
Goes FALSE, 3-78
Goes TRUE, 3-78
HF Rej, 3-33
Holdoff, 3-79, 3-111
Level, 3-34, 3-112, 3-115
LF Rej, 3-33
Mode & Holdoff, 3-35, 3-79, 3-111
NAND, 3-79, 3-82
Negative, 3-112, 3-113
Noise Rej, 3-33
NOR, 3-79, 3-82
Normal, 3-35, 3-79, 3-111
OR, 3-79, 3-82
Pattern, 3-77
Polarity, 3-113
Polarity and Width, 3-112
Positive, 3-112, 3-113
Pulse, 3-111, 3-113, 3-135
Reject Glitch, 3-112
Rising edge, 3-81
Runt, 3-113
Set Thresholds, 3-78
Set to 50%, 3-34, 3-113, 3-133
Set to ECL, 3-34, 3-112
Set to TTL, 3-34, 3-112
Slope, 3-34
Source, 3-32, 3-111, 3-113
State, 3-77, 3-81
Thresholds, 3-113
Trigger When, 3-78, 3-80
True for less than, 3-80
True for more than, 3-80
Type, 3-32, 3-111, 3-113, 3-135
Width, 3-112
MAIN TRIGGER OUTPUT, BNC, 2-5
Map Math, Color menu, 3-12
Map Reference, Color menu, 3-13
Math Waveform
Differential, A-2
FFT, A-2
Integral, A-2
Optional Advanced, A-2
Math waveform
derivative. *See Derivative math
waveform*
FFT. *See FFT math waveform*
integral. *See Integral math wave-
form*
Math waveforms, 3-148
Math, Color menu, 3-12
Math1/2/3, More menu, 3-148
Maximum, 3-84, *Glossary-5*
Mean, 3-84, *Glossary-6*
MEASURE button, 3-86
Measure Delay menu
Create Measrmnt, 3-92
Delay To, 3-90
Edges, 3-91
Measure Delay To, 3-90
OK Create Measurement, 3-92
Measure Delay To, Measure Delay
menu, 3-90
Measure menu, 2-10, 3-86, 3-93
Gating, 3-88
High Ref, 3-90
High-Low Setup, 3-89
Histogram, 3-89
Low Ref, 3-90
Mid Ref, 3-90
Mid2 Ref, 3-90
Min-Max, 3-89
Reference Levels, 3-89
Remove Measrmnt, 3-87, 3-93
Select Measrmnt, 3-86, 3-90

- Set Levels in % units**, 3-89
 - Snapshot**, 3-93
 - Measurement
 - Amplitude, 3-83, *Glossary-1*
 - Area, 3-83, *Glossary-1*
 - Burst width, 3-83, *Glossary-2*
 - Cycle area, 3-83, *Glossary-3*
 - Cycle mean, 3-83, *Glossary-3*
 - Cycle RMS, 3-83, *Glossary-3*
 - Delay, 3-90, *Glossary-3*
 - Duty cycle, 1-19, *Glossary-6*, *Glossary-7*
 - Fall time, 3-84
 - Frequency, 1-19, 3-84, *Glossary-3*
 - Gated, *Glossary-3*
 - High, 3-84, *Glossary-4*
 - Low, 3-84, *Glossary-5*
 - Maximum, 3-84, *Glossary-5*
 - Mean, 3-84, *Glossary-6*
 - Minimum, 3-84, *Glossary-6*
 - Negative duty cycle, 3-84
 - Negative overshoot, 3-84
 - Negative width, 3-84
 - Overshoot, *Glossary-7*
 - Peak to peak, 3-84, *Glossary-6*
 - Period, 3-85, *Glossary-6*
 - Phase, 3-84, *Glossary-7*
 - Positive duty cycle, 3-85
 - Positive overshoot, 3-85
 - Positive width, 3-85
 - Propagation delay, 3-84
 - Readout, 3-86
 - Reference levels, 1-20
 - Rise time, 1-19, 3-85, *Glossary-8*
 - RMS, 3-85, *Glossary-8*
 - Undershoot, *Glossary-6*
 - Width, 1-19, *Glossary-6*, *Glossary-7*
 - Measurement Accuracy, Ensuring
 - maximum, 3-94–3-99, 3-128–3-129
 - Measurements, 2-26–2-28, 3-83–3-93
 - Algorithms, A-7–A-20
 - Automated, 1-18, 2-26
 - Cursor, 2-27, 3-15
 - Gated, 3-88
 - Graticule, 2-28
 - Snapshot of, 3-92
 - Memory, Waveform, 3-124
 - Menu
 - Acquire, 3-5, 3-70
 - Color, 3-10
 - Cursor, 3-17
 - Delayed Trigger, 3-23–3-25
 - Display, 3-10, 3-26
 - File Utilities, 3-53
 - Horizontal, 2-18, 3-21
 - Main, 2-6
 - Main Trigger, 2-10, 3-32, 3-77, 3-111, 3-113, 3-135
 - Measure, 2-10, 3-86, 3-93
 - More, 2-10, 3-37, 3-124, 3-139, 3-148
 - See also *More menu*
 - Operation, 2-7
 - Pop-up, 2-8, *Glossary-7*
 - Pulse trigger, 2-10
 - Save/Recall, 3-120
 - Save/Recall Setup, 2-10
 - Save/Recall Waveform, 2-10, 3-123
 - Setup, 1-8
 - Status, 2-10, 3-130–3-131
 - Utility, 2-11, 3-58, 3-118
 - Mid Ref**, Measure menu, 3-90
 - Mid2 Ref**, Measure menu, 3-90
 - Min-Max**, Measure menu, 3-89
 - Minimum, 3-84, *Glossary-6*
 - Mode, Cursor, 2-27–2-28
 - Mode & Holdoff**, Main Trigger menu, 3-35, 3-79, 3-111
 - Mode**, Acquire menu, 3-5
 - Model number location, 2-3
 - Monochrome**, Color menu, 3-11
 - MORE** button, 3-72, 3-124, 3-126, 3-148
 - More menu, 2-10, 3-124, 3-139, 3-148
 - Average**, 3-149
 - Blackman-Harris**, 3-39
 - Change Math waveform definition**, 3-38, 3-139, 3-143, 3-149
 - dBV RMS**, 3-38
 - diff**, 3-140
 - Dual Wfm Math**, 3-149
 - FFT**, 3-38
 - Hamming**, 3-39
 - Hanning**, 3-39
 - intg**, 3-144
 - Linear RMS**, 3-38
 - Math1, Math2, Math3**, 3-37, 3-139, 3-143
 - Math1/2/3**, 3-148
 - No Process**, 3-149
 - OK Create Math Waveform**, 3-144, 3-149
 - Phase (deg)**, 3-38
 - Phase (rad)**, 3-38
 - Rectangular**, 3-38
 - Reference waveform status, 3-124
 - Set 1st Source to**, 3-150
 - Set 2nd Source to**, 3-150
 - Set FFT Source to**, 3-38
 - Set FFT Vert Scale to**, 3-38
 - Set FFT Window to**, 3-38
 - Set Function to**, 3-149
 - Set Function to**, 3-140, 3-144
 - Set operator to**, 3-150
 - Set Single Source to**, 3-149
 - Set Single Source to**, 3-139, 3-143
 - Single Wfm Math**, 3-139, 3-143, 3-149
-
- ## N
- NAND, *Glossary-6*
 - NAND**, Main Trigger menu, 3-79, 3-82
 - Negative duty cycle, 3-84
 - Negative overshoot, 3-84
 - Negative width, 3-84
 - Negative**, Main Trigger menu, 3-112, 3-113
 - No Process**, More menu, 3-149
 - Noise
 - reducing in FFTs, 3-45
 - reducing in phase FFTs, 3-39, 3-48
 - Noise Rej**, Main Trigger menu, 3-33
 - NOR, *Glossary-6*
 - NOR**, Main Trigger menu, 3-79, 3-82
 - Normal trigger mode, 2-14, *Glossary-6*
 - Normal**, Color menu, 3-11
 - Normal**, Main Trigger menu, 3-35, 3-79, 3-111
 - NTSC**, Display menu, 3-29
 - Nyquist frequency, 3-46
-
- ## O
- Off Bus**, Utility menu, 3-118
 - Offset
 - DC. See *DC Offset*
 - Vertical, 2-23, 3-138
 - vertical, 3-44, 3-141, 3-146
 - Offset**, Vertical menu, 3-138
 - OK Confirm Clear Spool**, Hardcopy menu, 3-60

Index

OK Create Math Wfm, More menu, 3-149
OK Create Measurement, Measure Delay menu, 3-92
OK Erase Ref & Panel Memory, Utility menu, 3-121
OK Store Template, Acquire menu, 3-71
ON/STBY button, 1-5, 2-3
Optical probes, 3-106
Options, A-1-A-6
Options, Color menu, 3-14
OR, *Glossary-6*
OR, Main Trigger menu, 3-79, 3-82
Oscilloscope, *Glossary-6*
Overall, Display menu, 3-27
Overshoot, *Glossary-7*
Overwrite Lock, File Utilities menu, 3-56

P

P6205 Active Probe, 1-3
Packaging, A-21
Paired cursor, 2-27, 3-15
PAL, Display menu, 3-29
Palette, Color menu, 3-11
Parity, Utility menu, 3-58
Passive voltage probes, 3-102–3-103
Pattern trigger, 3-75, 3-79
Pattern, Main Trigger menu, 3-77
PCX, 3-57
PCX Color, Hardcopy menu, 3-59
PCX, Hardcopy menu, 3-59
Peak to peak, 3-84, *Glossary-6*
Period, 3-85, *Glossary-6*
Persistence, 3-27
Persistence Palette, Color menu, 3-11
Phase, 3-84, *Glossary-7*
Phase suppression, 3-48
Phaser Color Printer, 3-57
Pixel, *Glossary-7*
Plotter, HC100, 3-57
Polarity and Width, Main Trigger menu, 3-112
Polarity, Main Trigger menu, 3-113
Pop-up menu, 2-8, *Glossary-7*
Port, Hardcopy menu, 3-59
Port, Utility menu, 3-58, 3-118
Portrait, Hardcopy menu, 3-59
Position
 Vertical, 2-23, 3-136
 vertical, 3-44, 3-141, 3-146
Position, Vertical menu, 3-138
Positive duty cycle, 3-85
Positive overshoot, 3-85
Positive width, 3-85
Positive, Main Trigger menu, 3-112, 3-113
Postscript, 3-57
Posttrigger, *Glossary-7*
Power connector, 1-4, 2-5
Power cords, A-1
Power off, 1-6
Power on, 1-5
Pretrigger, *Glossary-7*
Principal power switch, 1-5, 2-5
Print, File Utilities menu, 3-55
Printer
 HC220, 3-57
 Phaser, 3-57
Probe Cal, 3-94–3-99
Probes
 Accessories, A-4-A-6
 Active voltage, 3-104–3-105
 Additional, A-3
 By applications, 3-107, 3-108
 Compensation, 1-11, 3-100, *Glossary-7*
 Connection, 1-7
 Current, 3-105
 Definition, *Glossary-7*
 Delete Four Option, A-2
 Delete Two Option, A-2
 Differential active, 3-104
 Fixtured active, 3-104
 General purpose (high input resistance), 3-102
 High speed, 3-104
 High voltage, 3-103–3-104

Low impedance Z_0 , 3-102
Optical, 3-106
Passive, 3-100
Passive voltage, 3-102–3-103
Selection, 3-102–3-108
Time-to-voltage converter, 3-106

Propagation delay, 3-84

Pulse trigger, 2-14, 3-109

Pulse Trigger menu, 2-10

Pulse, Main Trigger menu, 3-111, 3-113, 3-135

Q

Quantizing, *Glossary-7*

R

Rack mounting, A-2

Readout

 Acquisition, 3-5
 Channel, 2-6, 3-126
 Cursors, 2-6
 Edge trigger, 3-32, 3-76
 General purpose knob, 2-6
 Measurement, 2-27, 3-86
 Record view, 2-6
 Snapshot, 3-92
 Time base, 2-6
 Trigger, 2-6, 3-134
 Trigger Level Bar, 3-28
 Trigger Point, 3-28

Readout, Cursor, Paired, 3-141

Readout, cursor

 H-Bars, 3-40, 3-141, 3-145
 Paired cursors, 3-41, 3-145
 V-Bars, 3-40, 3-141, 3-145

Readout, Display menu, 3-28

Real-time sampling, *Glossary-8*

Rear panel, 2-5, 3-118

Recall, Setups, 3-120–3-122

Recall Factory Setup, Save/Recall Setup menu, 3-121

Recall Saved Setup, Save/Recall Setup menu, 3-121

- Recalling, Waveforms, 3-123
- Record length, 1-1, 2-19, 3-68, *Glossary-8*
 derivative math waveforms, 3-139
 integral math waveforms, 3-143
- Record Length**, Horizontal menu, 3-68
- Record View, 2-6, 2-22, 3-67, 3-134
- Rectangular window, 3-38
- Ref**, Color menu, 3-13
- Ref1, Ref2, Ref3, Ref4, File**, Save/Recall Waveform menu, 3-124
- Ref1, Ref2, Ref3, Ref4**, Reference waveform status, 3-124
- Reference levels, 1-20, 3-89
- Reference Levels**, Measure menu, 3-89
- Reference memory, *Glossary-8*
- Reject Glitch**, Main Trigger menu, 3-112
- Remote communication, 3-116–3-119
- Remove Measrmt**, Measure menu, 3-87, 3-93
- Rename**, File Utilities menu, 3-54
- Reset All Mappings To Factory**, Color menu, 3-14
- Reset All Palettes To Factory**, Color menu, 3-14
- Reset Current Palette To Factory**, Color menu, 3-14
- Reset to Factory Color**, Color menu, 3-12
- Reset Zoom Factors**, Zoom menu, 3-153
- Restore Colors**, Color menu, 3-14
- Ring Bell if Condition Met**, Acquire menu, 3-73
- Rise time, 1-19, 3-85, *Glossary-8*
- Rising edge, Delayed Trigger menu, 3-24
- Rising edge, Main Trigger menu, 3-34, 3-81
- RLE Color**, Hardcopy menu, 3-59
- RMS, 3-85, *Glossary-8*
- RS-232, 2-5
- RS-232, **Port**, 3-59
- RS232**, Utility menu, 3-58
- RUN/STOP**, Acquire menu, 3-6
- Runt trigger, 3-109, 3-110, 3-113, *Glossary-8*
- Runt**, Main Trigger menu, 3-113
-
- ## S
- Safety, *xi*
 Symbols, *xi*
- Sample acquisition mode, 3-3, *Glossary-8*
- Sample interval, *Glossary-8*
- Sample**, Acquire menu, 3-5
- Sampling, 2-20, *Glossary-8*
- Saturation**, Color menu, 3-12
- Save, Setups, 3-120–3-122
- Save Current Setup**, Save/Recall Setup menu, 3-120
- Save Waveform**, Save/Recall Waveform menu, 3-123
- Save/Recall **SETUP** button, 1-8, 3-53, 3-120
- Save/Recall Setup menu, 2-10, 3-120
factory status, 3-120
File Utilities, 3-122
Recall Factory Setup, 3-121
Recall Saved Setup, 3-121
Save Current Setup, 3-120
user status, 3-120
- Save/Recall **WAVEFORM** button, 3-53, 3-123
- Save/Recall Waveform menu, 2-10, 3-123
active status, 3-123
Autosave, 3-125
Delete Refs, 3-124
empty status, 3-123
File Utilities, 3-125
Ref1, Ref2, Ref3, Ref4, File, 3-124
Save Waveform, 3-123
- Saving, Waveforms, 3-123
- Saving and recalling setups, 1-24, 3-120
- Saving and recalling waveforms, 3-123
- Scale, vertical, 3-44, 3-141, 3-146
- seconds**, Cursor menu, 3-19
- SELECT** button, 2-27, 3-18, *Glossary-8*
- Select Measrmt**, Measure menu, 3-86, 3-90
- Selected waveform, *Glossary-8*
- Selecting channels, 3-126
- Self test, 1-6
- Serial number, 2-5
- Set 1st Source to**, More menu, 3-150
- Set 2nd Source to**, More menu, 3-150
- Set Function to**, More menu, 3-149
- SET LEVEL TO 50%** button, 3-133
- Set Levels in % units**, Measure menu, 3-89
- Set operator to**, More menu, 3-150
- Set Single Source to**, More menu, 3-149
- Set Thresholds**, Main Trigger menu, 3-78
- Set to 10%**, Horizontal menu, 3-68
- Set to 50%**, Delayed Trigger menu, 3-25
- Set to 50%**, Horizontal menu, 3-68
- Set to 50%**, Main Trigger menu, 3-34, 3-113, 3-133
- Set to 90%**, Horizontal menu, 3-68
- Set to ECL**, Delayed Trigger menu, 3-24
- Set to ECL**, Main Trigger menu, 3-34, 3-112
- Set to TTL**, Delayed Trigger menu, 3-24
- Set to TTL**, Main Trigger menu, 3-34, 3-112
- Set to Zero**, Vertical menu, 3-138
- Setting Up for the Examples, 1-7
- Settings**, Display menu, 3-10, 3-26
- Setup menu, 1-8
- Setups, Save and recall, 3-120–3-122
- Shipping, A-21
- Side menu, *Glossary-9*
- Side menu buttons, 2-3, *Glossary-9*
- SIGNAL OUTPUT**, BNC, 2-5
- Signal Path Compensation, 1-3, 3-128–3-129
- Sin(x)/x interpolation, 2-20, 3-29, *Glossary-5*

Index

Sin(x)/x interpolation, Display menu, 3-29

Single Acquisition Sequence, Acquire menu, 3-7

SINGLE TRIG button, 3-7, 3-133

Single Wfm Math, More menu, 3-149

Slope, *Glossary-9*

Slope, Delayed Trigger menu, 3-24

Slope, Main Trigger menu, 3-34

Slope, Trigger, 2-17

Snapshot, Readout, 3-92

Snapshot of Measurements, 1-22, 3-92

Snapshot, Measure menu, 3-93

Soft Flagging, Utility menu, 3-58

Software, 1-1

Software Setup, Utility menu, 3-58

Software version, 3-130

Source, Delayed Trigger menu, 3-24

Source, Main Trigger menu, 3-32, 3-111, 3-113

Spectral, Color menu, 3-11

Spooler, Hardcopy, 3-60

Start up, 1-3

State trigger, 3-81

State, Main Trigger menu, 3-77, 3-81

STATUS button, 3-130

Status menu, 2-10, 3-130–3-131

- Display**, 3-130
- Firmware version, 3-130
- I/O**, 3-130
- System**, 3-130
- Trigger**, 3-130
- Waveforms**, 3-130

Stop After Limit Test Condition Met, Acquire menu, 3-73

Stop After, Acquire menu, 3-6, 3-73

Stop Bits, Utility menu, 3-58

Style, Display menu, 3-26

Switch, principal power, 1-5, 2-5

System, Status menu, 3-130

System, Utility menu, 3-58, 3-118

T

Talk/Listen Address, Utility menu, 3-118

Tek Secure, 3-121, *Glossary-9*

Tek Secure Erase Memory, Utility menu, 3-121

Temperature compensation, 3-128–3-129

Temperature, Color menu, 3-11

Template Source, Acquire menu, 3-70

Text/Grat, Display menu, 3-27

Thinkjet, 3-57

Thinkjet, Hardcopy menu, 3-59

Thresholds, Main Trigger menu, 3-113

TIFF, 3-57

TIFF, Hardcopy menu, 3-59

Time base, *Glossary-9*

Time Base, Horizontal menu, 3-21, 3-67

Time Units, Cursor menu, 3-19

Time-to-voltage converter, 3-106

TOGGLE button, 3-18

Tracking Mode, Cursor, 2-28

Tracking, Cursor menu, 3-18

Trigger, 2-13–2-18, 3-8, *Glossary-9*

- AC Line Voltage, 2-14
- Auxiliary, 2-14
- Coupling, 2-16
- Delay, 2-18
- Delayed, 3-20–3-25
- Edge, 2-14, 3-32, *Glossary-3*
- Glitch, 3-109, 3-110, *Glossary-4*
- Holdoff, 2-15
- Level, 2-17, *Glossary-9*
- Logic, 2-14, 3-75–3-82
- Mode, 2-14
- Pattern, 3-75, 3-79
- Position, 2-17, 3-68
- Pulse, 2-14, 3-109
- Readout, 3-134
- Runt, 3-109, 3-110, 3-113, *Glossary-8*

- Slope, 2-13, 2-17
- Source, 2-13
- State, 3-81
- Status Lights, 3-133
- Types, 3-135
- Video, 2-14
- Width, 3-109, 3-115

Trigger Bar, 2-6

Trigger Bar Style, Display menu, 3-28

Trigger Level Bar, Readout, 3-28

Trigger **MAIN LEVEL** knob, 1-12, 2-17, 3-132

TRIGGER MENU button, 3-32, 3-77, 3-111, 3-113, 3-135

Trigger Point, Readout, 3-28

Trigger Position, Horizontal menu, 3-68

Trigger Status Lights, 3-133

Trigger When, Main Trigger menu, 3-78, 3-80

Trigger, Status menu, 3-130

True for less than, Main Trigger menu, 3-80

True for more than, Main Trigger menu, 3-80

Type, Main Trigger menu, 3-32, 3-111, 3-113, 3-135

U

Undershoot, *Glossary-6*

user, Saved setup status, 3-120

UTILITY button, 3-58, 3-118

Utility Menu

- OK Erase Ref & Panel Memory**, 3-121

- Tek Secure Erase Memory**, 3-121

Utility menu, 2-11, 3-58, 3-118

- Baud Rate**, 3-58

- Configure**, 3-58, 3-118

- GPIO**, 3-58, 3-118

- Hard Flagging**, 3-58

- Hardcopy**, 3-118

Hardcopy (Talk Only), 3-58
Hardware Setup, 3-58
I/O, 3-58, 3-118
Off Bus, 3-118
Parity, 3-58
Port, 3-58, 3-118
RS232, 3-58
Soft Flagging, 3-58
Software Setup, 3-58
Stop Bits, 3-58
System, 3-58, 3-118
Talk/Listen Address, 3-118

V

V Limit, Acquire menu, 3-71
Variable Persistence, Display menu, 3-27
 Vectors, 3-27
Vectors, Display menu, 3-27
 Vertical, 3-8
 Bar cursors, 2-27, 3-15, *Glossary-9*
 Control, 3-136–3-138
 Offset, 2-23, 3-138
 Position, 2-23, 3-136
 POSITION knob, 2-23
 Readout, 3-136
 Scale, 3-136
 SCALE knob, 1-11, 2-23
 System, 1-11, 2-23
 Vertical Menu, **Cal Probe**, 3-94
 Vertical menu
 100 MHz, 3-138
 20 MHz, 3-138
 Bandwidth, 3-138
 Coupling, 3-137
 Fine Scale, 3-138
 Full, 3-138
 Offset, 3-138
 Position, 3-138
 Set to Zero, 3-138
VERTICAL MENU button, 1-15
 Vertical position, for DC correction of FFTs, 3-44
 Vertical **POSITION** knob, 3-136
 Vertical Readout, 3-136
 Vertical **SCALE** knob, 3-136
 VGA Output, 2-5
Video Line Number, Cursor menu, 3-19
 Video Trigger, Option 5, A-2
 Video trigger, 2-14
View Palette, Color menu, 3-11

W

WARNING, statement in manual, *xi*
 Waveform, *Glossary-9*
 Interval, *Glossary-9*
 Math, 3-148–3-150
 Off priority, 3-127
 Waveform clipping. *See Clipping*
 Waveform differentiation, 3-139
 Waveform FFTs, 3-36
 Waveform integration, 3-143
 Waveform memory, 3-124
WAVEFORM OFF button, 1-17, 3-30, 3-127
 Waveform record
 FFT, 3-42
 FFT frequency domain, 3-42
 length of, 3-42
 FFT source, 3-42
 acquisition mode, 3-45
 defined, 3-42
 long versus short, 3-45
 FFT time domain, 3-42–3-52
Waveform, Display menu, 3-27
 Waveforms, Math, 3-148
Waveforms, Status menu, 3-130
 Width, 1-19, *Glossary-6*, *Glossary-7*
 Width trigger, 3-109, 3-115
Width, Main Trigger menu, 3-112
 Window, 3-49
 Blackman-Harris, 3-39, 3-49, 3-52

characteristics of, 3-51
 Hamming, 3-39, 3-49, 3-52
 Hanning, 3-39, 3-49, 3-52
 rectangular, 3-38, 3-49, 3-52
 rectangular vs. bell-shaped, 3-51
 selecting, 3-49

Windowing, process, 3-49
 Windows, descriptions of, 3-38–3-39

X

XY, Format, 3-29–3-31
 XY format, *Glossary-9*
XY, Display menu, 3-30

Y

YT, Format, 3-29–3-31
 YT format, *Glossary-9*
YT, Display menu, 3-30

Z

Zero phase reference point, 3-42, 3-47
 establishing for impulse testing, 3-47–3-52
 Zoom, 3-151–3-154
 derivative math waveforms, 3-142
 on FFT math waveforms, 3-45
 on integral math waveforms, 3-147
ZOOM button, 3-151
 Zoom feature, 2-25
 Zoom menu
 Reset Zoom Factors, 3-153
 Zoom Off, 3-153
Zoom Off, Zoom menu, 3-153

