

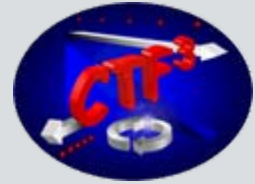

UPPSALA
UNIVERSITET

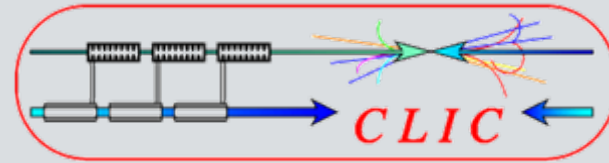

CLIC Feasibility Demonstration at CTF3

Roger Ruber

Uppsala University, Sweden,
for the CLIC/CTF3 Collaboration

<http://cern.ch/clic-study>

LINAC'10 – MO303
13 Sep 2010

The Key to CLIC Efficiency

- NC Linac for 1.5 TeV/beam
 - accelerating gradient: **100 MV/m**
 - RF frequency: **12 GHz**
- Total active length for 1.5 TeV: **15 km**
 - individual klystrons not realistic
- **Two-beam acceleration scheme**
- Luminosity of $2 \times 10^{34} \text{ cm}^{-2} \text{ s}^{-1}$
 - short pulse (156ns)
 - high rep-rate (50Hz)
 - very small beam size (1x100nm)
- 64 MW RF power / accelerating structure of 0.233m active length
 - 275 MW/m
- Estimated wall power **415 MW** at 7% efficiency

Main Linac	
C.M. Energy	3 TeV
Peak luminosity	$2 \times 10^{34} \text{ cm}^{-2} \text{ s}^{-1}$
Beam Rep. rate	50 Hz
Pulse time duration	156 ns
Average gradient	100 MV/m
# cavities	2 x 71,548

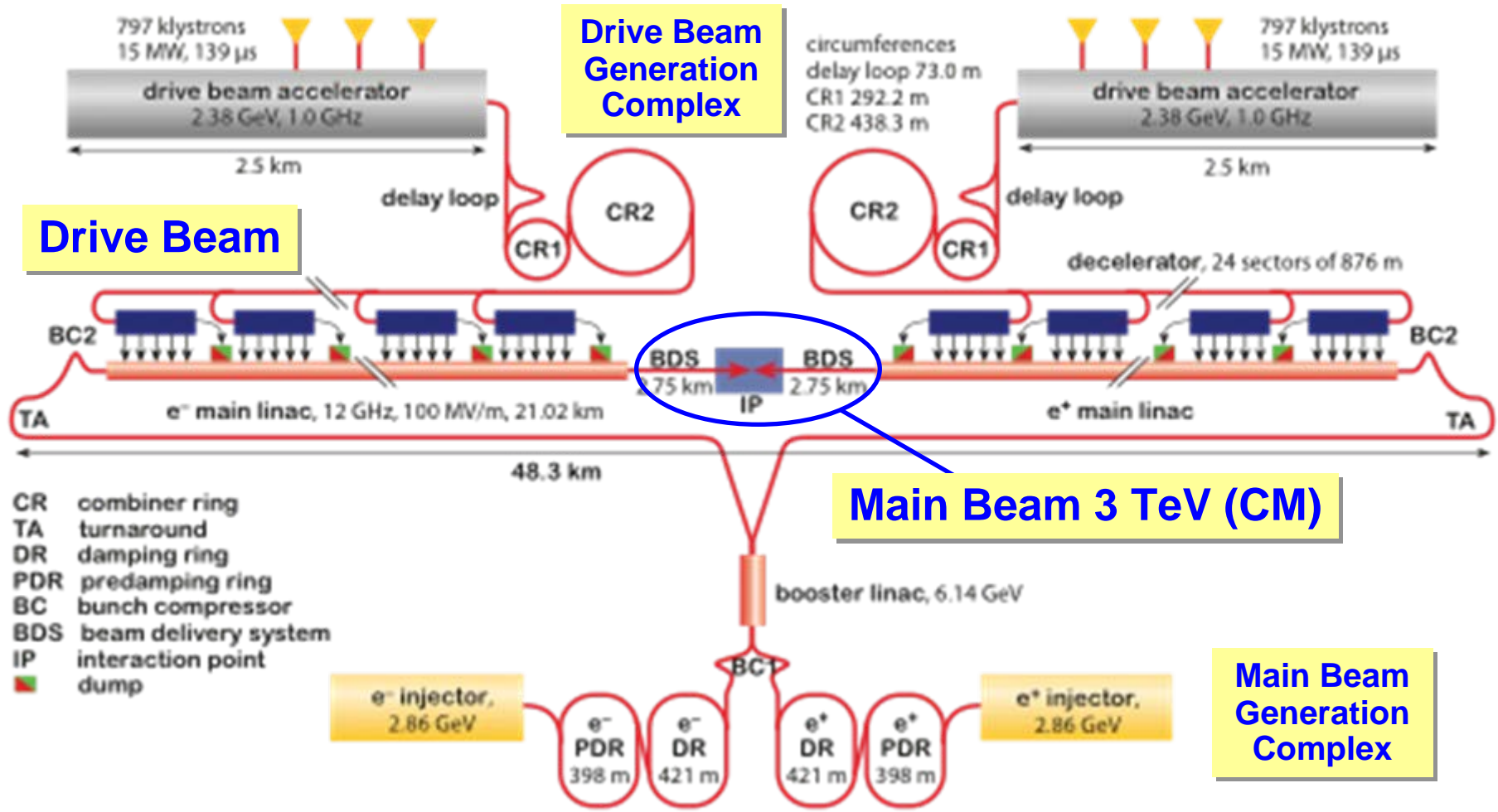

- CR combiner ring
- TA turnaround
- DR damping ring
- PDR predamping ring
- BC bunch compressor
- BDS beam delivery system
- IP interaction point
- dump

CLIC Two-beam Acceleration Scheme

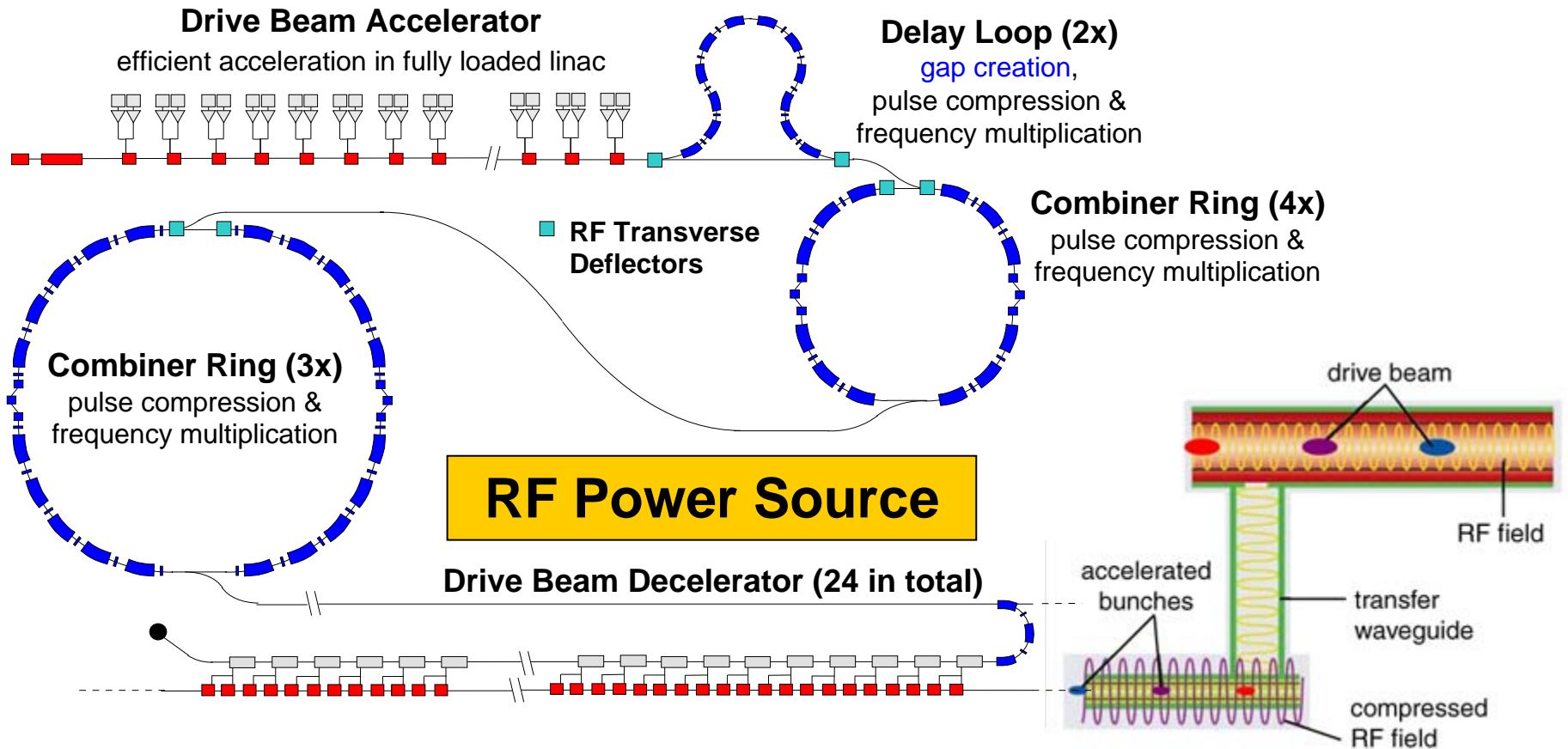

Drive beam time structure - initial

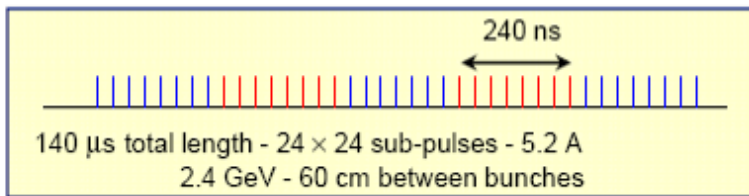

Drive beam time structure - final

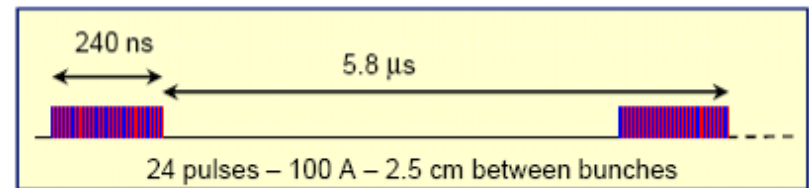

- **Drive beam generation**, with
 - appropriate time structure, and
 - fully loaded acceleration
- **Two-beam acceleration**, with CLIC prototype (TBTS)
 - accelerating structures
 - power production structures (PETS)
- **Deceleration stability** (TBL)
- **Photoinjector** (PHIN)

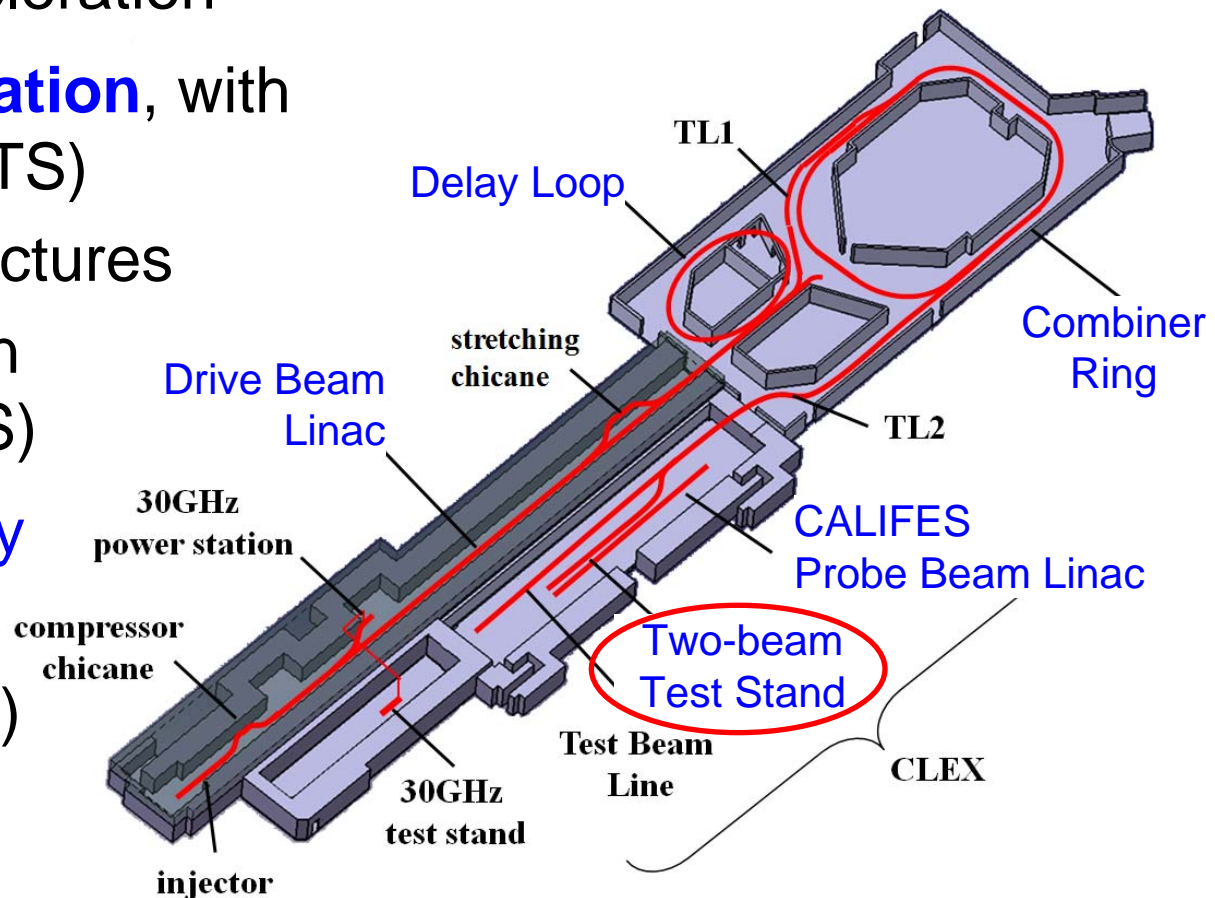

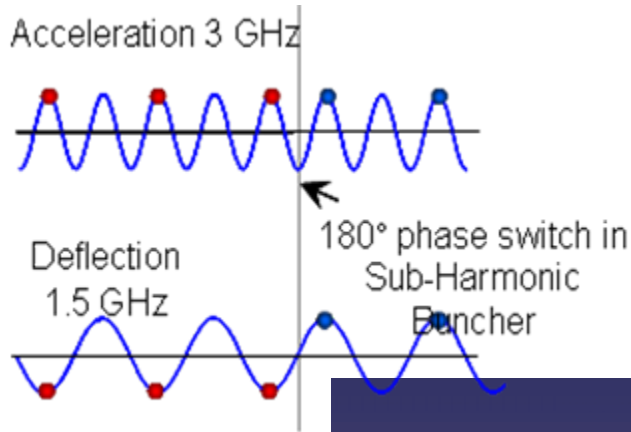

Delay Loop

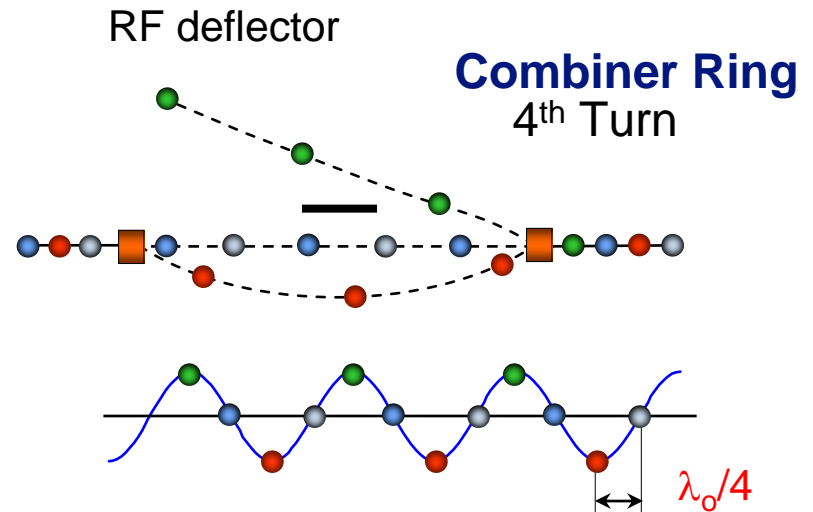
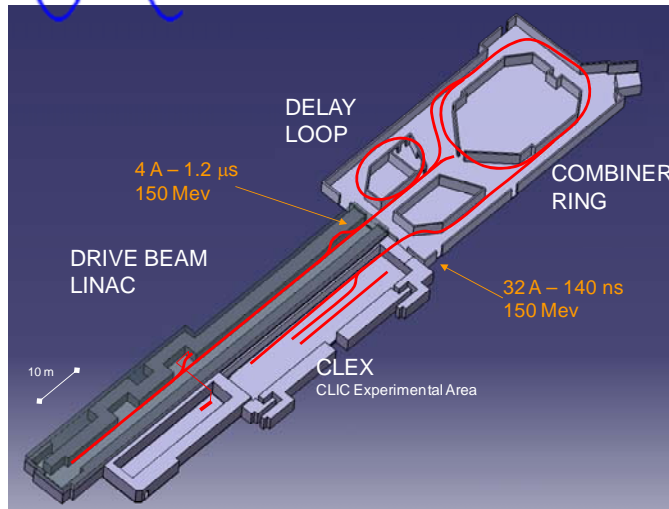
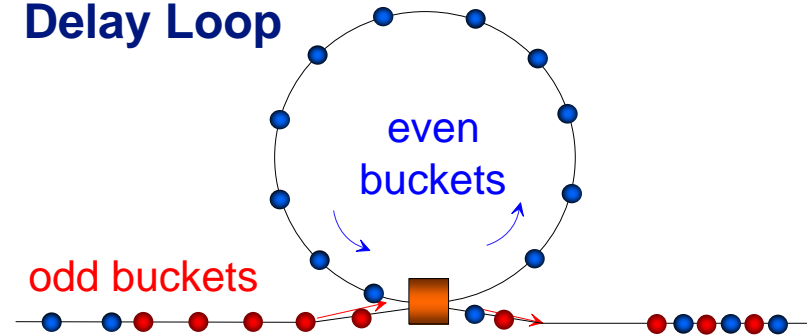

Initial time structure

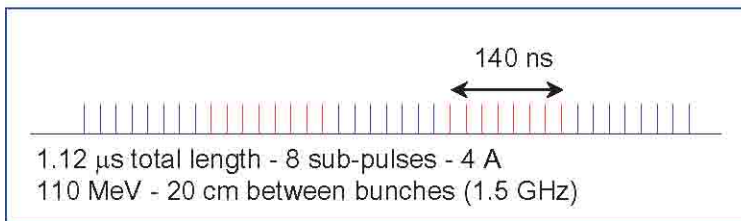

Final time structure

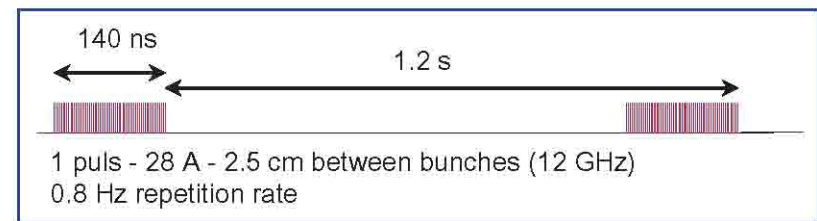

- **Streak camera images from CR**
- bunch spacing:
 - 666 ps initial
 - 83 ps final
- circulation time correction by wiggler adjustment

• Signal from BPMs

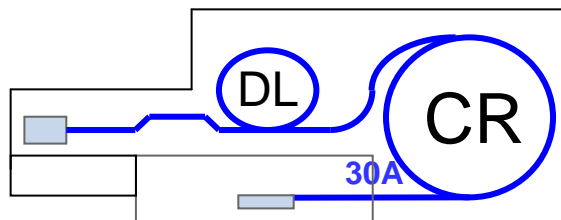

Turn 1



Turn 2

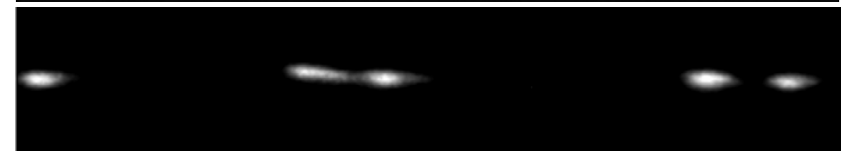

Turn 3

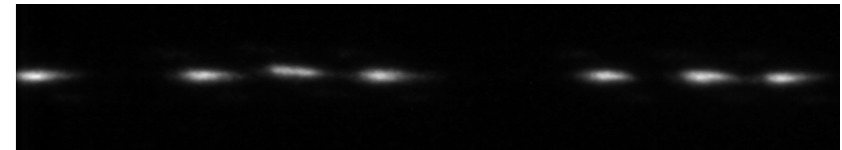

Turn 4

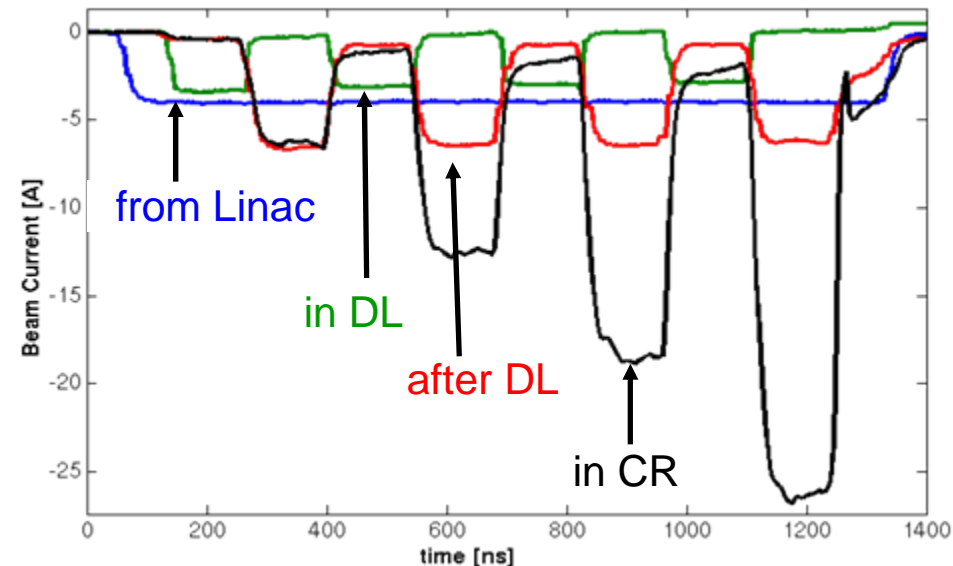
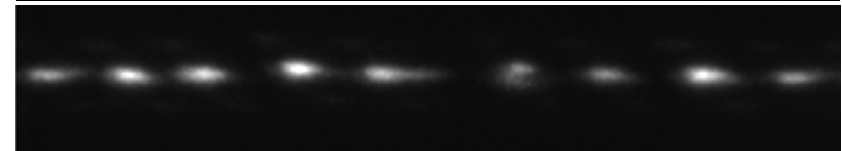



• Beam current stabilization

- CLIC requires stability at 0.075% level
- ok from linac and DL
need improvement in CR

	LINAC	DL	CR
Variation	0.13%	0.20%	1.01%

• Phase stabilization

- temperature stabilization
pulse compressor cavity

• Transfer line commissioning

- transport losses from CR to experiment hall

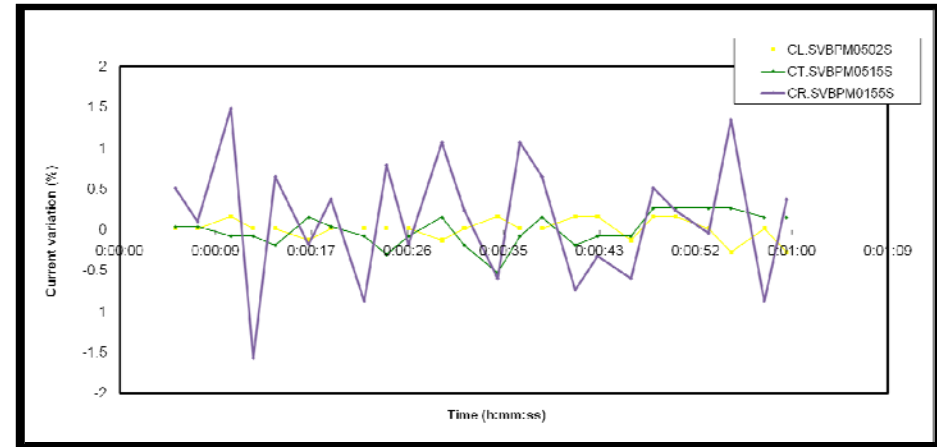

RF phase stability $\Delta\Phi$
along pulse
(for different
ambient
temperatures)

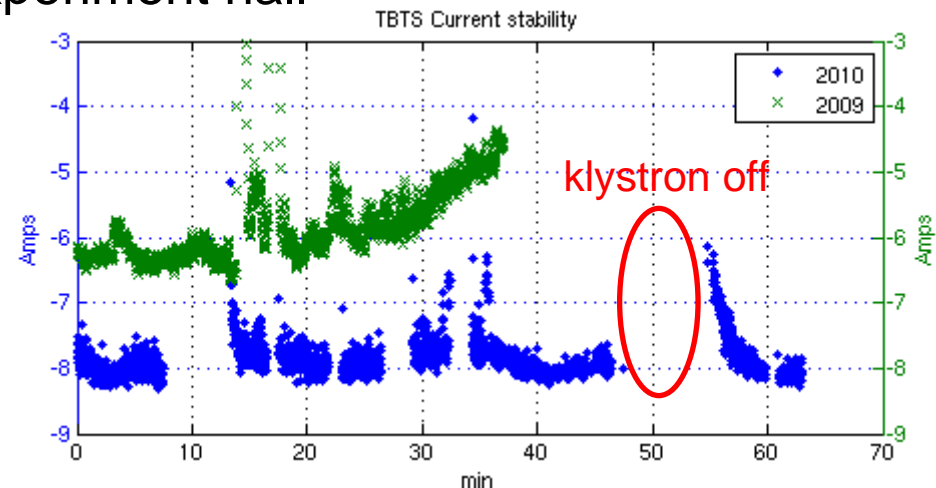
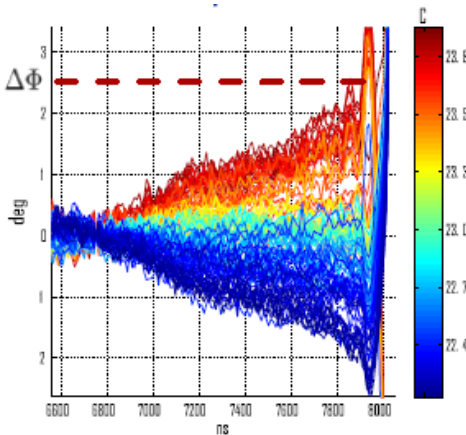

Two-beam Test Stand

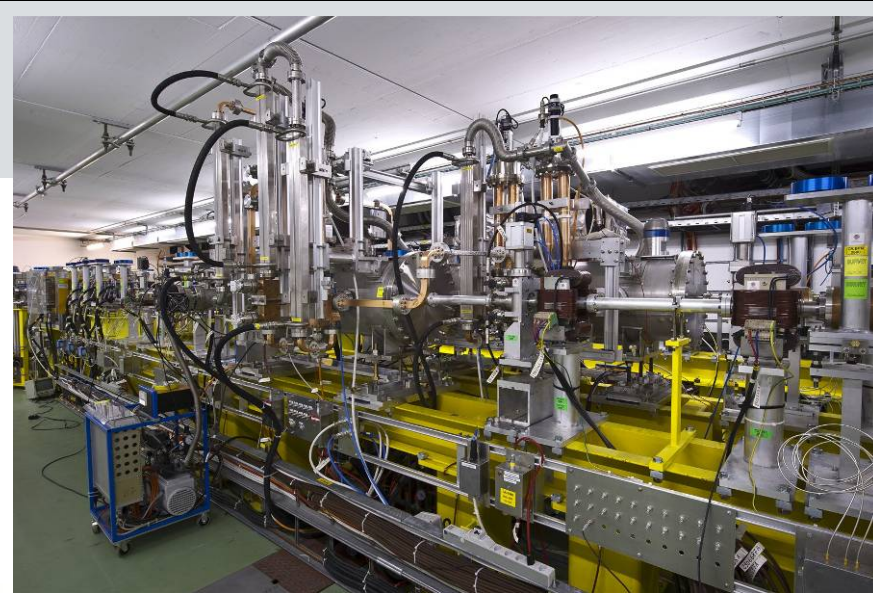
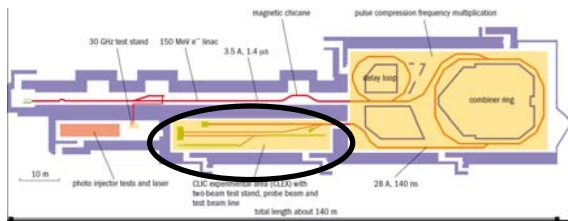

Spectrometers
and beam dumps

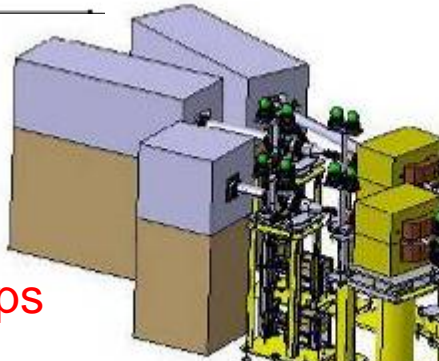

Experimental area

CTF3 drive-beam

CALIFES probe-beam



Construction supported by the Swedish Research Council and the Knut and Alice Wallenberg Foundation

Two-beam Test Stand Prospects

Versatile facility

- two-beam operation
 - 28A drive beam [100A at CLIC]
 - 1A probe beam [like CLIC]
- excellent beam diagnostics, long lever arms
- easy access & flexibility for future upgrades

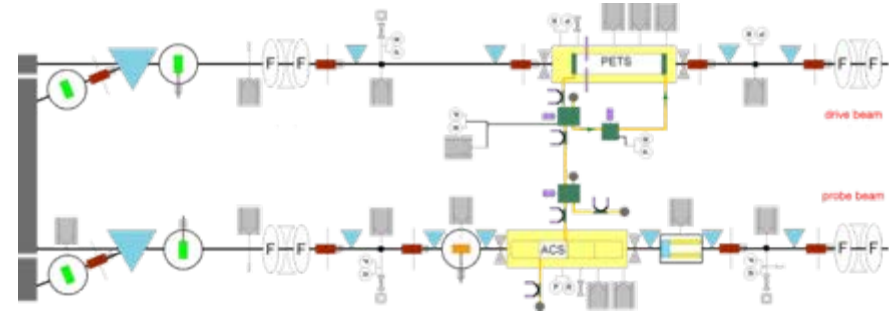

Unique test possibilities

- power production in prototype CLIC PETS
- two-beam acceleration and full CLIC module
- studies of
 - beam kick & RF breakdown
 - beam dynamics effects
 - beam-based alignment

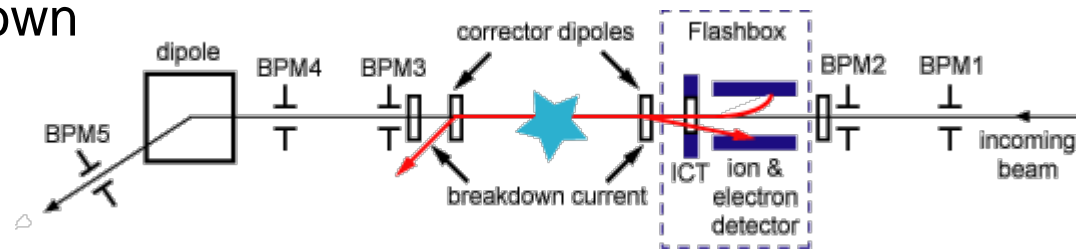



- Fine tuning DB↔PB timing
 - **3GHz phase scan klystron**
 - coherent with 1.5GHz laser timing signal
- **~6 MeV peak-to-peak**
 - zero crossing: 177 MeV, 205 degr.
 - phase scaling: 5.58 (expect 4x)
- optimize
 - PB energy spread & bunching
 - klystron pulse compression
 - coherency klystron and laser
 - low input power (ACS not conditioned)

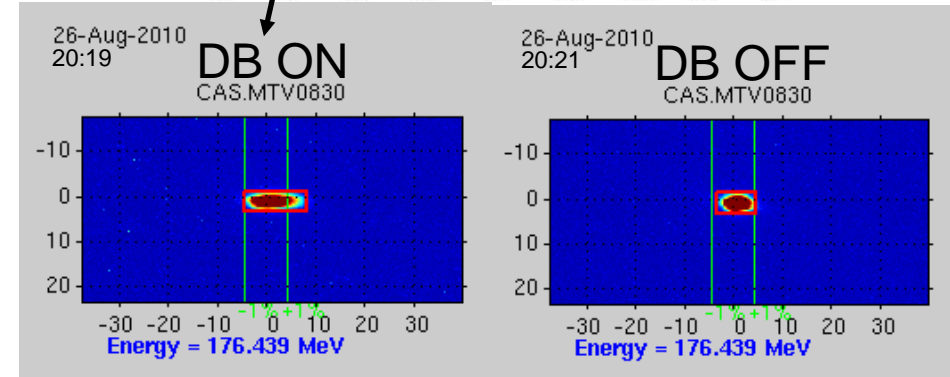
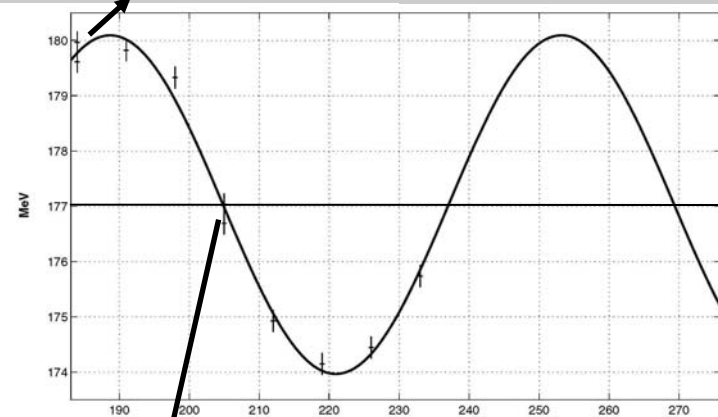
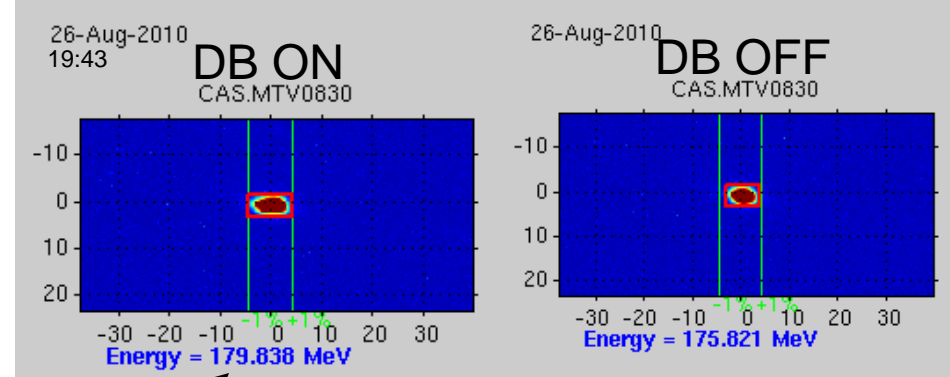

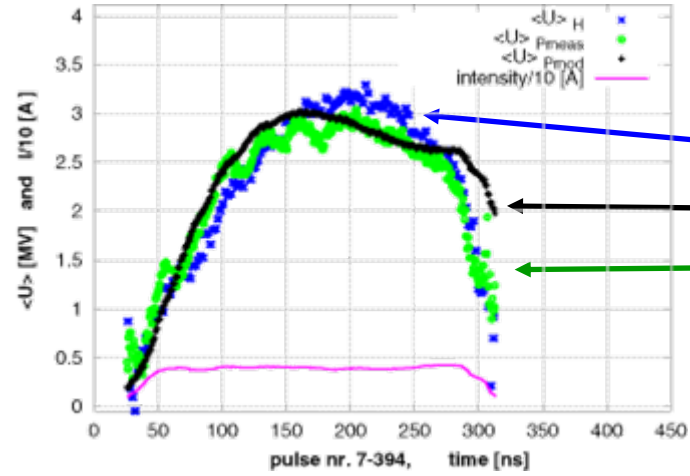
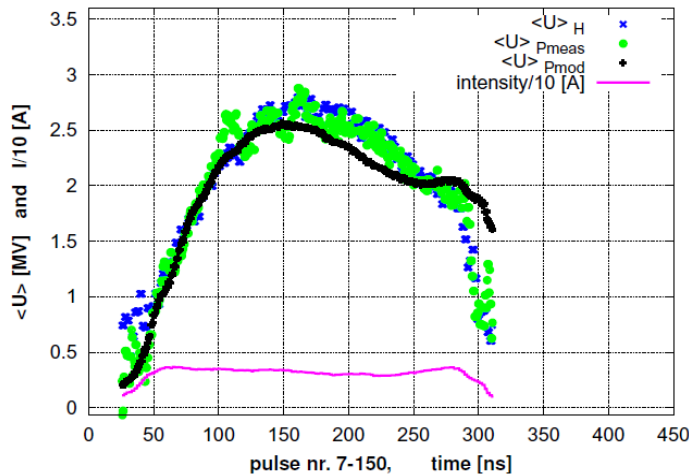

BPM position
BPM intensity
BPM intensity + PETS power

Energy loss estimation

→ mismatch black-green due to phase variation along pulse

Improve by incorporating incoming beam info

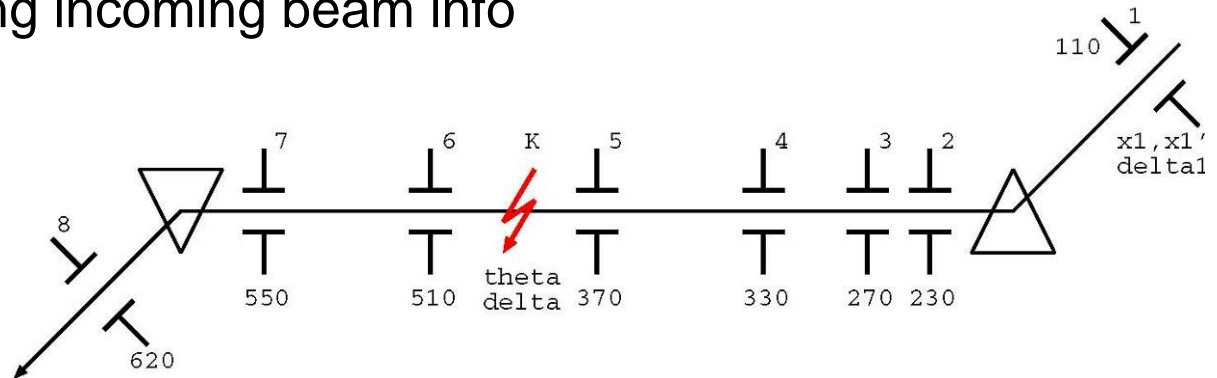

Present stable level:

- **PETS + recirculation loop**
 - ~70 MW peak power,
 - ~200 ns pulse
- **Accelerating structure**
 - ~23 MW peak power

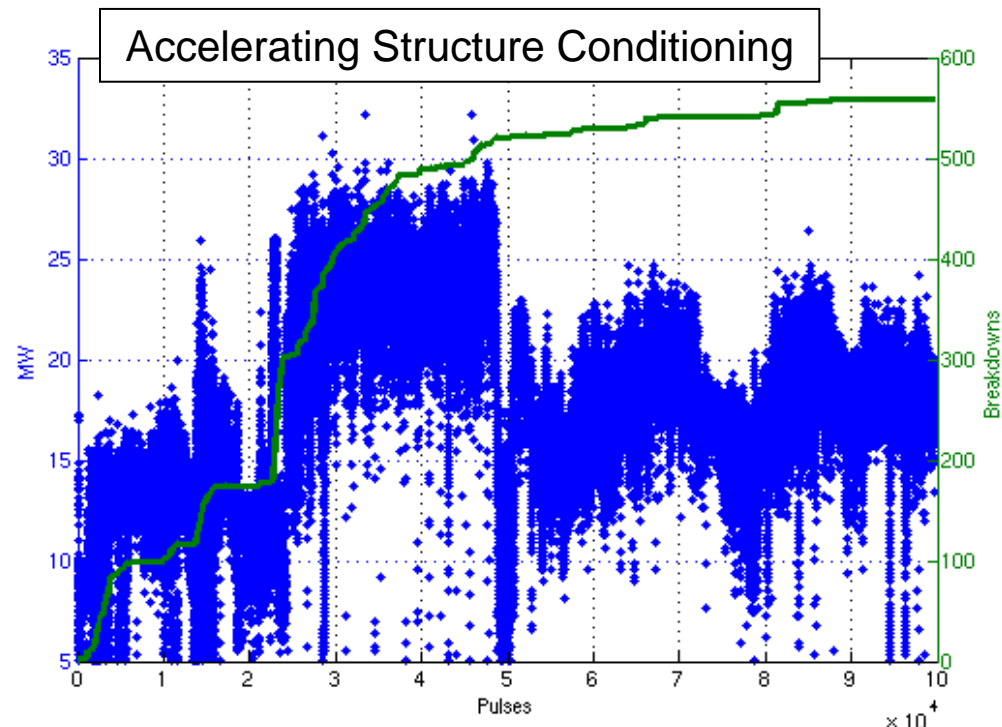
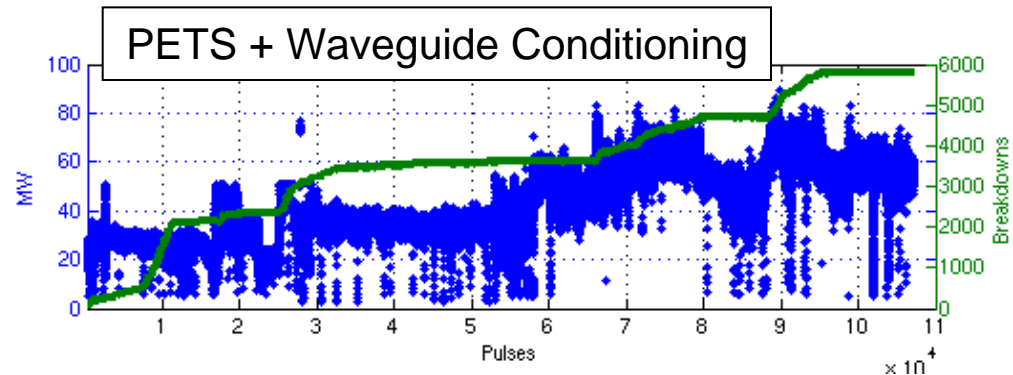
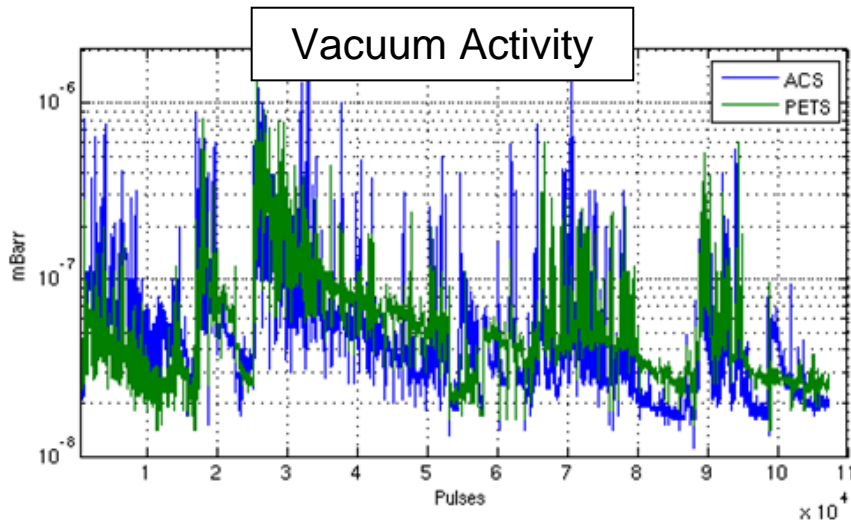

Example RF Breakdowns

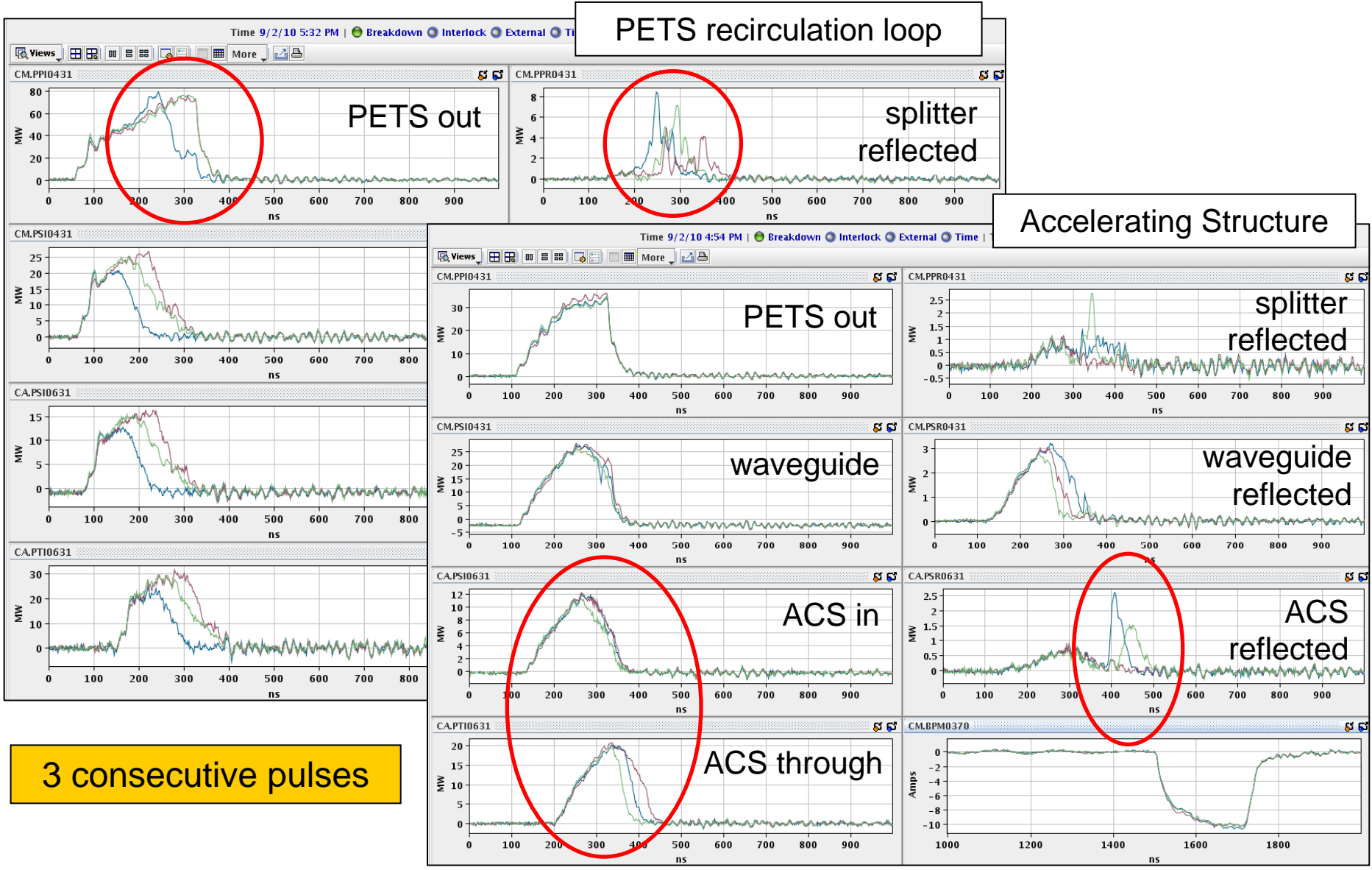

- Two-beam acceleration

- conditioning and test PETS and accelerating structures
- breakdown kicks of beam
- dark (electron) current accompanied by ions
- install 1, then 3, two-beam modules

- Drive beam generation

- phase feed forward for phase stability
- increase to 5 Hz repetition rate
- coherent diffraction radiation experiments

- Drive beam deceleration

- extend TBL to 8 then 16 PETS
- high power production + test stand

- 12GHz klystron powered test stand

- power testing structures w/o beam
- significantly higher repetition rate (50 Hz)



TBTS is the only place available to investigate effects of RF breakdown on the beam



- Reached first milestones:
 - Drive beam generation with appropriate time structure and fully loaded acceleration.
 - Two-beam acceleration with CLIC prototype structures.
- Continued operation:
 - Optimize beam and two-beam acceleration.
 - Investigate RF breakdown effects on beam.
- Planned enhancements:
 - 12 GHz klystron powered test stand
 - Install full two-beam test modules.

Many thanks to
all colleagues,
their work and
their suggestions!