

Programmer Manual

Tektronix

**TDS Family Digitizing Oscilloscopes
(TDS 410A, 420A, 460A, 520A, 524A, 540A, 544A,
620A, 640A, 644A, 684A, 744A & 784A)**

070-8709-07

Copyright © Tektronix, Inc. 1995. All rights reserved. Licensed software products are owned by Tektronix or its suppliers and are protected by United States copyright laws and international treaty provisions.

Use, duplication, or disclosure by the Government is subject to restrictions as set forth in subparagraph (c)(1)(ii) of the Rights in Technical Data and Computer Software clause at DFARS 252.227-7013, or subparagraphs (c)(1) and (2) of the Commercial Computer Software – Restricted Rights clause at FAR 52.227-19, as applicable.

Tektronix products are covered by U.S. and foreign patents, issued and pending. Information in this publication supercedes that in all previously published material. Specifications and price change privileges reserved.

Printed in the U.S.A.

Tektronix, Inc., P.O. Box 1000, Wilsonville, OR 97070-1000

TEKTRONIX and TEK are registered trademarks of Tektronix, Inc.

WARRANTY

Tektronix warrants that this product will be free from defects in materials and workmanship for a period of three (3) years from the date of shipment. If any such product proves defective during this warranty period, Tektronix, at its option, either will repair the defective product without charge for parts and labor, or will provide a replacement in exchange for the defective product.

In order to obtain service under this warranty, Customer must notify Tektronix of the defect before the expiration of the warranty period and make suitable arrangements for the performance of service. Customer shall be responsible for packaging and shipping the defective product to the service center designated by Tektronix, with shipping charges prepaid. Tektronix shall pay for the return of the product to Customer if the shipment is to a location within the country in which the Tektronix service center is located. Customer shall be responsible for paying all shipping charges, duties, taxes, and any other charges for products returned to any other locations.

This warranty shall not apply to any defect, failure or damage caused by improper use or improper or inadequate maintenance and care. Tektronix shall not be obligated to furnish service under this warranty a) to repair damage resulting from attempts by personnel other than Tektronix representatives to install, repair or service the product; b) to repair damage resulting from improper use or connection to incompatible equipment; or c) to service a product that has been modified or integrated with other products when the effect of such modification or integration increases the time or difficulty of servicing the product.

THIS WARRANTY IS GIVEN BY TEKTRONIX WITH RESPECT TO THIS PRODUCT IN LIEU OF ANY OTHER WARRANTIES, EXPRESSED OR IMPLIED. TEKTRONIX AND ITS VENDORS DISCLAIM ANY IMPLIED WARRANTIES OF MERCHANTABILITY OR FITNESS FOR A PARTICULAR PURPOSE. TEKTRONIX' RESPONSIBILITY TO REPAIR OR REPLACE DEFECTIVE PRODUCTS IS THE SOLE AND EXCLUSIVE REMEDY PROVIDED TO THE CUSTOMER FOR BREACH OF THIS WARRANTY. TEKTRONIX AND ITS VENDORS WILL NOT BE LIABLE FOR ANY INDIRECT, SPECIAL, INCIDENTAL, OR CONSEQUENTIAL DAMAGES IRRESPECTIVE OF WHETHER TEKTRONIX OR THE VENDOR HAS ADVANCE NOTICE OF THE POSSIBILITY OF SUCH DAMAGES.

Table of Contents

Getting Started

Overview of the Manual	1-1
Setting Up Remote Communications	1-3

Syntax and Commands

Command Syntax	2-1
Command and Query Structure	2-1
Clearing the TDS Family Oscilloscope	2-3
Command Entry	2-3
Constructed Mnemonics	2-6
Argument Types	2-7
Syntax Diagrams	2-10
Command Groups	2-11
Acquisition Commands	2-11
Alias Commands	2-12
Application Menu Commands	2-12
Calibration and Diagnostic Commands	2-13
Cursor Commands	2-13
Display Commands	2-14
File System Commands	2-16
Hardcopy Commands	2-17
Horizontal Commands	2-17
Limit Test Commands	2-19
Measurement Commands	2-19
Miscellaneous Commands	2-21
RS-232 Commands	2-22
Save and Recall Commands	2-22
Status and Error Commands	2-23
Trigger Commands	2-24
Vertical Commands	2-31
Waveform Commands	2-32
Zoom Commands	2-37
Command Descriptions	2-39

Status and Events

Registers	3-1
Queues	3-5
Event Handling Sequence	3-6
Synchronization Methods	3-7
Messages	3-12

Programming Examples

Compiling the Example Programs	4-2
--	-----

Appendices

Appendix A: Character Charts	A-1
Appendix B: Reserved Words	B-1
Appendix C: Interface Specifications	C-1
GPIB Function Subsets	C-1
Interface Messages	C-2
Appendix D: Factory Initialization Settings	D-1

Glossary and Index

List of Figures

Figure 1–1: Common Message Elements	1–1
Figure 1–2: Functional Groupings and an Alphabetical List of Commands	1–2
Figure 1–3: Service Requests (SRQs) Provide for Event (Interrupt) Driven Programs	1–2
Figure 1–4: The Disks That Accompany This Manual	1–3
Figure 1–5: GPIB Connector Location	1–3
Figure 1–6: How to Stack GPIB Connectors	1–4
Figure 1–7: Typical GPIB Network Configurations	1–5
Figure 1–8: Selecting the I/O System in the Main Menu	1–5
Figure 1–9: Selecting the GPIB Address in the GPIB Configuration Side Menu	1–6
Figure 2–1: Command Message Elements	2–2
Figure 2–2: Block Argument Example	2–9
Figure 2–3: Typical Syntax Diagrams	2–10
Figure 2–4: Message Window Coordinates	2–197
Figure 2–5: LESSThan and MOREThan Arguments	2–239
Figure 3–1: The Standard Event Status Register (SESR)	3–2
Figure 3–2: The Status Byte Register (SBR)	3–2
Figure 3–3: The Device Event Status Enable Register (DESER)	3–3
Figure 3–4: The Event Status Enable Register (ESER)	3–4
Figure 3–5: The Service Request Enable Register (SRER)	3–4
Figure 3–6: Status and Event Handling Process	3–6
Figure 3–7: Command Processing Without Using Synchronization .	3–8
Figure 3–8: Processing Sequence With Synchronization	3–8
Figure 4–1: Equipment Needed to Run the Example Programs	4–1

List of Tables

Table 2–1: BNF Symbols and Meanings	2–1
Table 2–2: Command Message Elements	2–2
Table 2–3: Comparison of Header Off and On Responses	2–3
Table 2–4: Acquisition Commands	2–11
Table 2–5: Alias Commands	2–12
Table 2–6: Application Menu Commands	2–12
Table 2–7: Calibration and Diagnostic Commands	2–13
Table 2–8: Cursor Commands	2–13
Table 2–9: Display Commands	2–14
Table 2–10: File System Commands	2–16
Table 2–11: Hardcopy Commands	2–17
Table 2–12: Horizontal Commands	2–17
Table 2–13: Limit Test Commands	2–19
Table 2–14: Measurement Commands	2–20
Table 2–15: Miscellaneous Commands	2–21
Table 2–16: RS-232 Commands	2–22
Table 2–17: Save and Recall Commands	2–23
Table 2–18: Status and Error Commands	2–23
Table 2–19: Trigger Commands	2–25
Table 2–20: Vertical Commands	2–31
Table 2–21: Waveform Commands	2–35
Table 2–22: Zoom Commands	2–37
Table 2–23: Waveform Data Points Supported for Reference Locations	2–54
Table 2–24: Commands that Affect BUSY? Response	2–60
Table 2–25: Offset Ranges for the TDS 4XXA, 54XA, 6XXA, & 7XXA (All Channels) and the TDS 520A & 524A (Channel 1 & Channel 2) using a 1x Probe	2–65
Table 2–26: Offset Ranges for the TDS 520A & 524A (Aux 1 & Aux 2) using a 1x Probe	2–65
Table 2–27: DATA and WFMPre Parameter Settings	2–90
Table 2–28: XY Format Pairs	2–112
Table 2–30: Record Length Values (<NR1>)	2–154
Table 2–31: Commands that Generate an Operation Complete Message	2–201
Table 2–32: Additional WFMPre Commands	2–295

Table 3-1: SESR Bit Functions	3-2
Table 3-2: SBR Bit Functions	3-3
Table 3-3: No Event Messages	3-12
Table 3-4: Command Error Messages – CME Bit 5	3-12
Table 3-5: Execution Error Messages – EXE Bit 4	3-14
Table 3-6: Device Error Messages – DDE Bit 3	3-17
Table 3-7: System Event Messages	3-17
Table 3-8: Execution Warning Messages – EXE Bit 4	3-18
Table 3-9: Internal Warning Messages	3-19
Table A-1: The TDS Character Set	A-1
Table A-2: ASCII & GPIB Code Chart	A-2
Table C-1: TDS Family Oscilloscope Standard Interface Message ..	C-2
Table D-1: Factory Initialization Settings	D-1

Preface

This programmer manual covers the TDS 410A, 420A, 460A, 520A, 524A, 540A, 544A, 620A, 640A, 644A, 684A, 744A, & 784A. It also covers Advanced DSP Math (optional on the TDS420A, 460A, 520A, 540A, 620A, & 640A), the RS-232/Centronics Interface (optional on the TDS 410A, 420A, 460A, 520A, 540A, 620A, & 640A), and the Option 05 Video Trigger. This manual provides information on operating your oscilloscope using the General Purpose Interface Bus (GPIB) interface.

Related Manuals

Table i lists other documentation for the TDS 410A, 420A, 460A, 520A, 524A, 540A, 544A, 620A, 640A, 644A, 684A, 744A, & 784A digitizing oscilloscopes.

Table i: Other Documentation

Manual	Tek Part Number
<i>TDS User Manual</i>	
TDS 410A, 420A, & 460A	070-8034-XX
TDS 520A, TDS 524A, TDS 540A, & TDS 544A	070-8710-XX
TDS 620A, TDS 640A, & TDS 644A	070-8715-XX
TDS 684A, 744A, & 784A	070-8991-XX
TDS 500A & 600A Option 05 Video Trigger	070-8748-XX
<i>TDS Reference</i>	
TDS 410A, 420A, & 460A	070-8035-XX
TDS 500A & TDS 600A	070-8711-XX
TDS 684A, 744A, & 784A	070-8999-XX
<i>TDS Performance Verification</i>	
TDS 410A, 420A, & 460A	070-8721-XX
TDS 520A, 524A, 540A, & 544A	070-8712-XX
TDS 620A, 640A, & 644A	070-8717-XX
TDS 684A, 744A, & 784A	070-8990-XX

Table i: Other Documentation (Cont.)

Manual	Tek Part Number
<i>TDS Service Manual</i>	
TDS 410A, 420A, & 460A	070-8036-XX
TDS 520A, 524A, 540A, & 544A	070-8713-XX
TDS 620A, 640A, & 644A	070-8718-XX
TDS 684A, 744A, & 784A	070-8992-XX

Getting Started

You can write computer programs that remotely set the oscilloscope front panel controls or take measurements and read those measurements for further analysis or storage.

To help you get started with programming the oscilloscope, this section includes the following:

- *Overview of the Manual* – summarizes the type of programming information contained in each major section of this manual.
- *Setting Up Remote Communications* – describes how to physically connect the oscilloscope to a controller and set the appropriate front panel controls.

Overview of the Manual

The information contained in each major section of this manual is described below.

Syntax and Commands

The *Syntax and Commands* section (Section 2) describes the structure and content of the messages your program sends to the digitizing oscilloscope. Figure 1–1 shows a syntax diagram and command parts as described in the *Command Syntax* subsection.

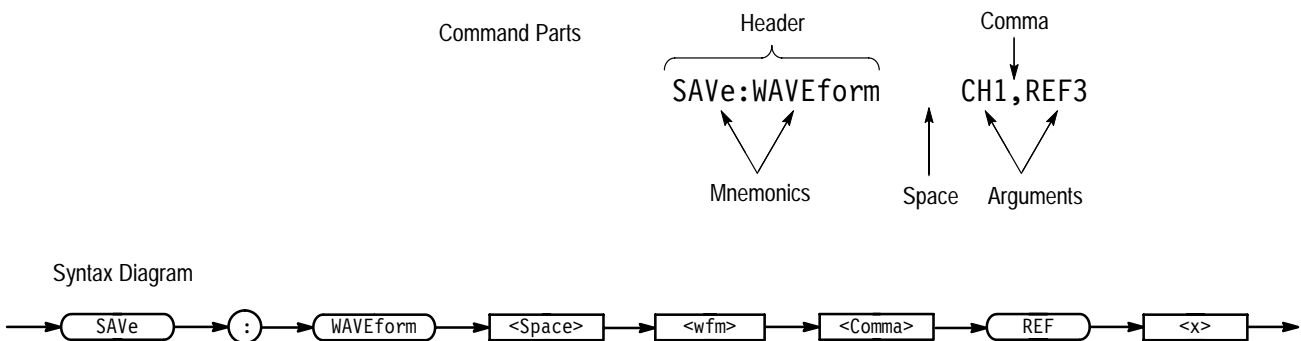

Figure 1–1: Common Message Elements

Section 2 also describes the effect of each command and provides examples of how you might use it. The *Command Groups* subsection provides a list by functional area. The *Command Descriptions* subsection arranges commands alphabetically (Figure 1–2).

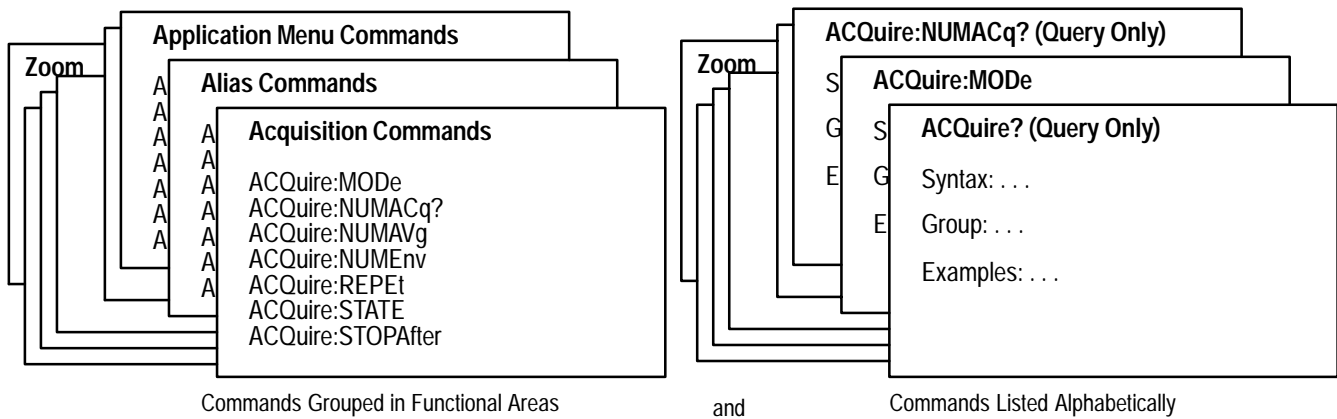

Figure 1-2: Functional Groupings and an Alphabetical List of Commands

Status and Events

The program may request information from the oscilloscope. The oscilloscope provides information in the form of status and error messages. Figure 1-3 illustrates the basic operation of this system.

The *Status and Events* section (Section 3) starting on page 3-1 describes how to use service requests (SRQs) and various event messages in your programs.

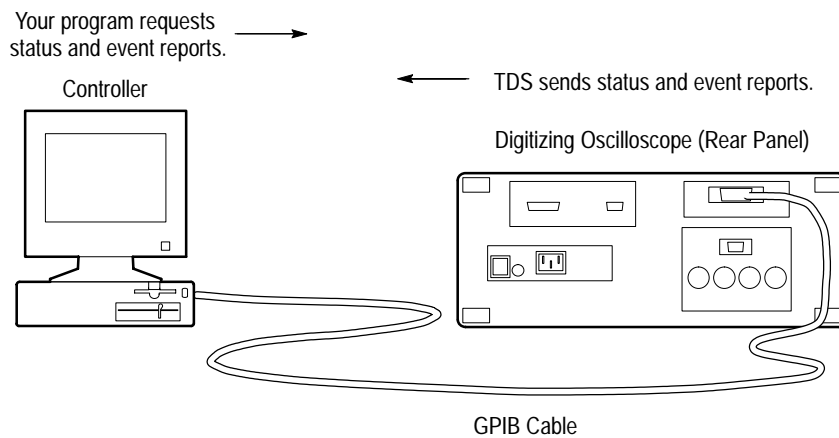

Figure 1-3: Service Requests (SRQs) Provide for Event (Interrupt) Driven Programs

Programming Examples

The *Programming Examples* section (Section 4) starting on page 4-1 describes some example digitizing oscilloscope programs and how to compile them. The disks that come with this manual (Figure 1-4) have an executable and a Microsoft QuickBASIC 4.5 and a Microsoft QuickC 2.5 source code version of each program.

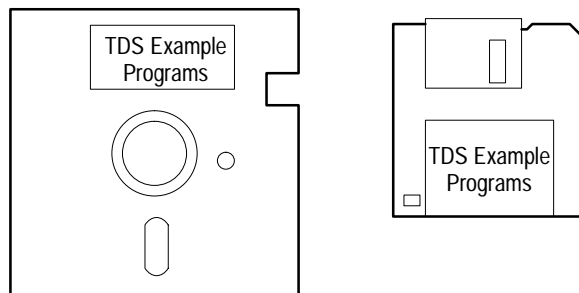

Figure 1-4: The Disks That Accompany This Manual

Setting Up Remote Communications

Even the best instrument control program will not do much if the instrument is not connected to the controller.

The digitizing oscilloscope has a 24-pin **GPIB** connector on its rear panel, as shown in Figure 1-5. This connector has a D-type shell and conforms to IEEE Std 488.1-1987.

Attach an IEEE Std 488.1-1987 GPIB cable (available from Tektronix as part number 012-0991-00) to this connector.

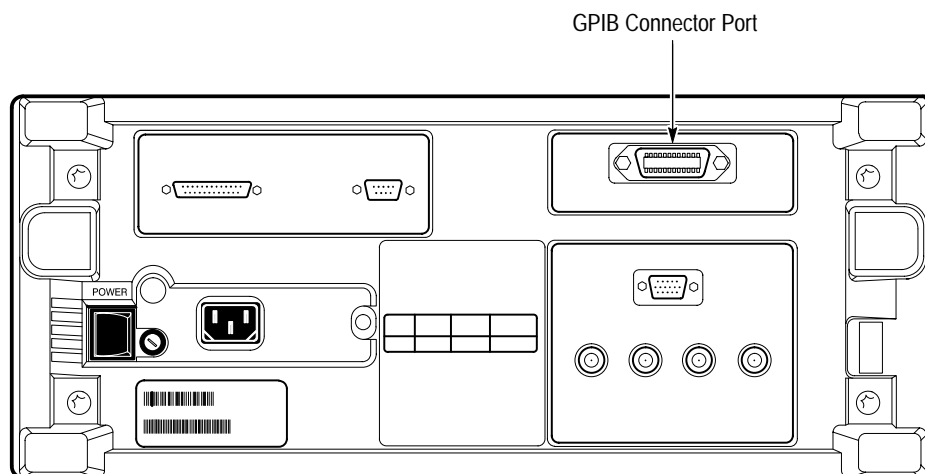

Figure 1-5: GPIB Connector Location

If needed, you can stack GPIB connectors as shown in Figure 1–6.

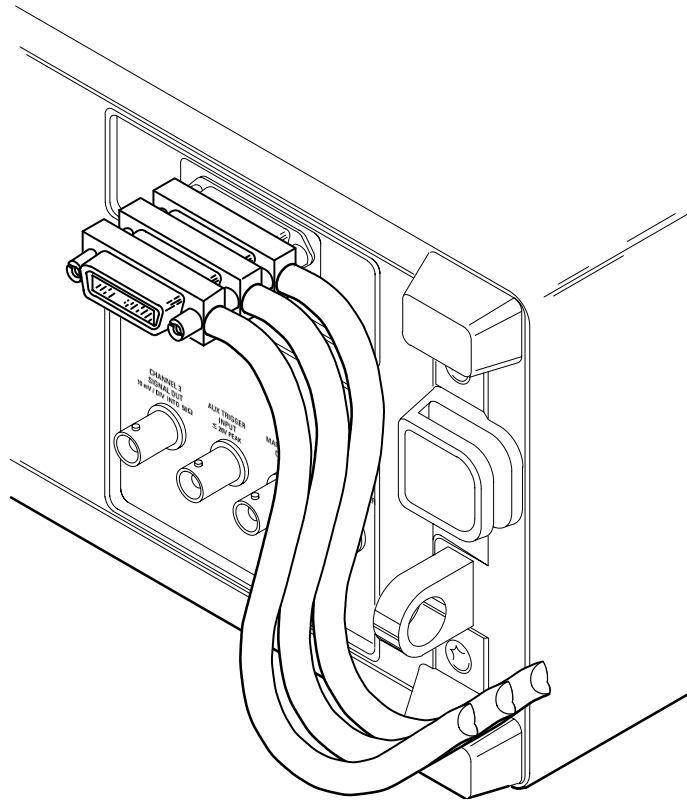

Figure 1–6: How to Stack GPIB Connectors

GPIB Requirements

Observe these rules when you use your digitizing oscilloscope with a GPIB network:

- Assign a unique device address to each device on the bus. No two devices can share the same device address.
- Do not connect more than 15 devices to any one bus.
- Connect one device for every 2 meters (6 feet) of cable used.
- Do not use more than 20 meters (65 feet) of cable to connect devices to a bus.
- Turn on at least two-thirds of the devices on the network while using the network.
- Connect the devices on the network in a star or linear configuration as shown in Figure 1–7. Do not use loop or parallel configurations.

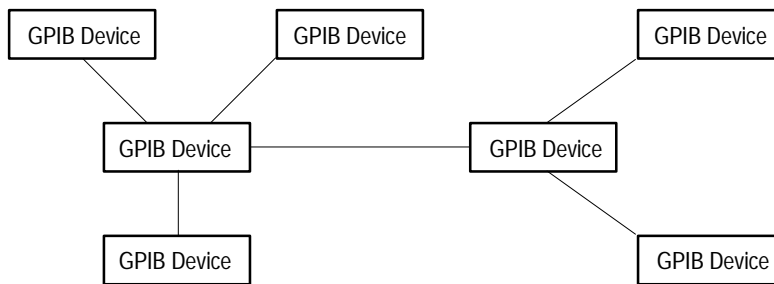

Figure 1-7: Typical GPIB Network Configurations

Appendix C: Interface Specifications gives more information on the GPIB configuration of the digitizing oscilloscope.

Setting the GPIB Parameters

You need to set the GPIB parameters of the digitizing oscilloscope to match the configuration of the bus. Once you have set these parameters, you can control the digitizing oscilloscope through the GPIB interface.

1. Press the **UTILITY (SHIFT DISPLAY)** button to display the Utility menu.
2. Press the **System** button in the main menu until it highlights the **I/O** selection in the pop-up menu. See Figure 1-8.

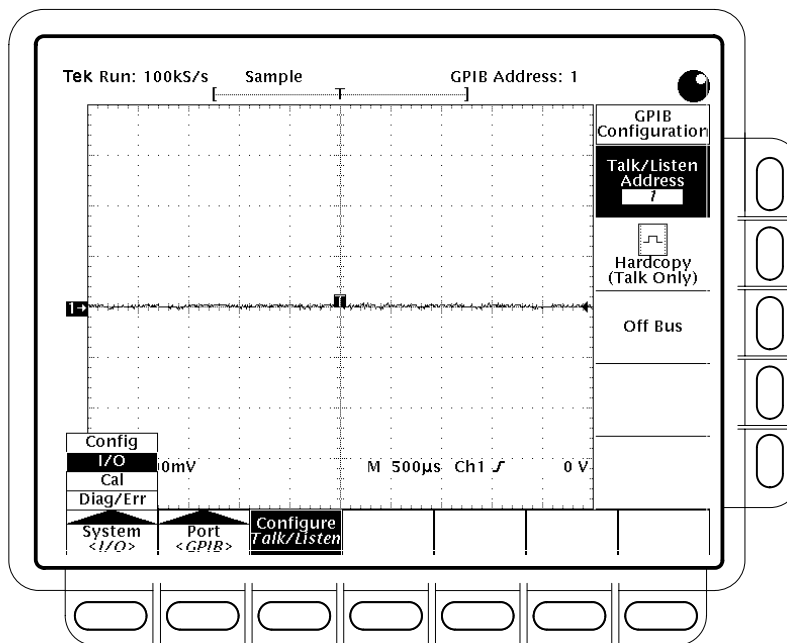

Figure 1-8: Selecting the I/O System in the Main Menu

3. Press the **Port** button in the main menu until it highlights the **GPIB** selection in the pop-up menu. See Figure 1–9.
4. Press the **Configure** button in the main menu to display the GPIB Configuration side menu. See Figure 1–9.
5. Press the **Talk/Listen Address** side menu button, and set the GPIB address using either the general purpose knob or, if available, the keypad.

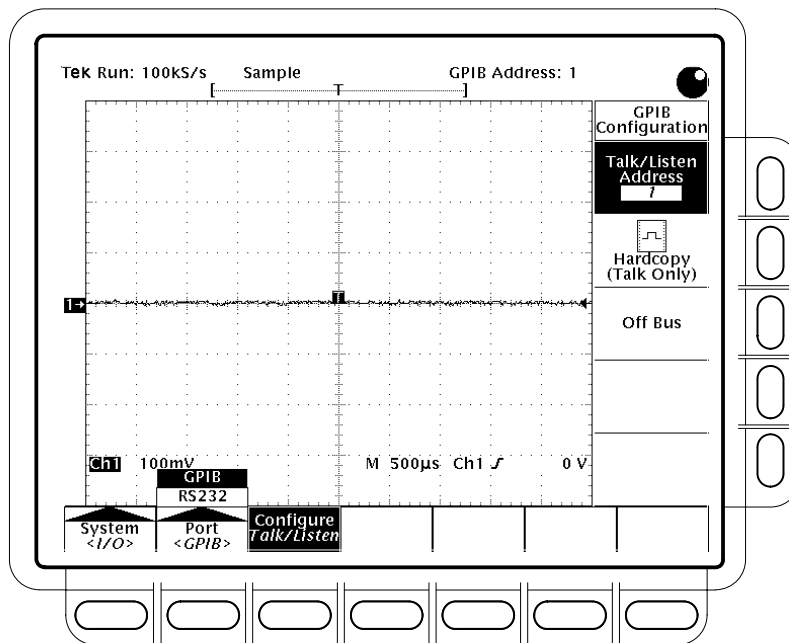

Figure 1–9: Selecting the GPIB Address in the GPIB Configuration Side Menu

The digitizing oscilloscope is set up for bidirectional communication with your controller. If you wish to isolate the digitizing oscilloscope from the bus:

- Press the **Off Bus** side menu button. This disables all communication with the controller.

If you wish to enter a special mode of operation to communicate directly with non-488.2 hard copy devices:

- Press the **Hardcopy** side menu button to have the digitizing oscilloscope send hard copy information only when you press the **HARDCOPY** button (and accept a HARDCOPY ABORT command).

Command Syntax

You can control the digitizing oscilloscope through the GPIB interface using commands and queries. This section describes the syntax these commands and queries use. It also describes the conventions the digitizing oscilloscope uses to process them. The next section, entitled *Command Groups*, lists the commands and queries themselves.

You transmit commands to the digitizing oscilloscope using the enhanced American Standard Code for Information Interchange (ASCII) character encoding. *Appendix A: Character Charts* on page A-2 contains a chart of the ASCII character set.

This manual describes commands and queries using Backus-Naur Form (BNF) notation and syntax diagrams.

This manual uses the following BNF symbols:

Table 2-1: BNF Symbols and Meanings

Symbol	Meaning
< >	Defined element
::=	Is defined as
	Exclusive OR
{ }	Group; one element is required
[]	Optional; can be omitted
. . .	Previous element(s) may be repeated
()	Comment

Command and Query Structure

Commands consist of set commands and query commands (usually simply called commands and queries). Commands modify instrument settings or tell the digitizing oscilloscope to perform a specific action. Queries cause the digitizing oscilloscope to return data and information about its status.

Most commands have both a set form and a query form. The query form of the command differs from the set form by its question mark on the end. For example, the set command `ACQuire:MODE` has a query form `ACQuire:MODE?`. Not all commands have both a set and a query form. Some commands have set only and some have query only.

A command message is a command or query name followed by any information the digitizing oscilloscope needs to execute the command or query. Command messages may contain five element types, defined in Table 2–2 and shown in the example in Figure 2–1.

Table 2–2: Command Message Elements

Symbol	Meaning
<Header>	The basic command name. If the header ends with a question mark, the command is a query. The header may begin with a colon (:) character. If the command is concatenated with other commands, the beginning colon is required. Never use the beginning colon with command headers beginning with a star (*).
<Mnemonic>	A header subfunction. Some command headers have only one mnemonic. If a command header has multiple mnemonics, a colon (:) character always separates them from each other.
<Argument>	A quantity, quality, restriction, or limit associated with the header. Some commands have no argument while others have multiple arguments. A <Space> separates arguments from the header. A <Comma> separates arguments from each other.
<Comma>	A single comma between arguments of multiple-argument commands. It may optionally have white space characters before and after the comma.
<Space>	A white space character between command header and argument. It may optionally consist of multiple white space characters.

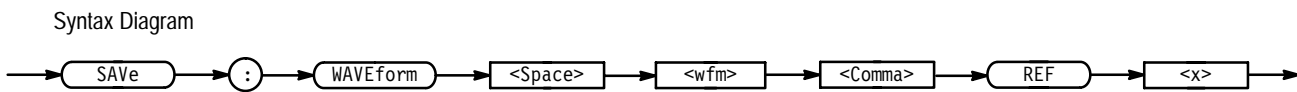
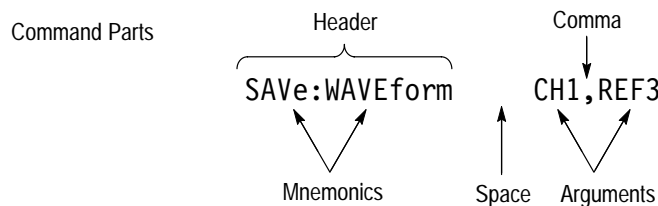

Figure 2–1: Command Message Elements

Commands Commands have the structure:

- [:] <Header> [<Space> <Argument> [<Comma> <Argument>] ...]

A command header consists of one or more mnemonics arranged in a hierarchical or tree structure. The first mnemonic is the base or root of the tree and each subsequent mnemonic is a level or branch off the previous one. Commands at a higher level in the tree may affect those at a lower level. The leading colon (:) always returns you to the base of the command tree.

Queries Queries have the structure:

- [:] <Header> ?
- [:] <Header> ? [<Space> <Argument> [<Comma> <Argument>] . . .]

You can specify a query command at any level within the command tree unless otherwise noted. These branch queries return information about all the mnemonics below the specified branch or level. For example, MEASUREMENT:MEAS<x>:DELAY:DIRection? returns the starting point and direction of the edge of a delayed measurement, while MEASUREMENT:MEAS<x>:DELAY? returns the current settings of all delayed measurement parameters, and MEASUREMENT:MEAS<x>? returns all the measurement parameters for the specified measurement.

Headers in Query Responses

You can control whether the digitizing oscilloscope returns headers as part of the query response. Use the HEADER command to control this feature. If header is on, the query response returns command headers and formats itself as a valid set command. When header is off, the response includes only the values. This may make it easier to parse and extract the information from the response. Table 2–3 shows the difference in responses.

Table 2–3: Comparison of Header Off and On Responses

Query	Header Off Response	Header On Response
APPMENU:TITLe?	"Test Setup"	:APPMENU:TITLE "Test Setup"
ACQUIRE:NUMAVg?	100	:ACQUIRE:NUMAVG 100

Clearing the TDS Family Oscilloscope

You can clear the Output Queue and reset the digitizing oscilloscope to accept a new command or query by using the Device Clear (DCL) GPIB command.

Command Entry

- You can enter commands in upper or lower case.

- You can precede any command with white space characters. White space characters include any combination of the ASCII control characters 00 through 09 and 0B through 20 hexadecimal (0 through 9 and 11 through 32 decimal).
- The digitizing oscilloscope ignores commands consisting of any combination of white space characters and line feeds.

Abbreviating Commands

You can abbreviate many digitizing oscilloscope commands. Each command listing in the *Commands* section shows the minimum acceptable abbreviations in capitals. For example, you can enter the command `ACQuire:NUMAVg` simply as `ACQ:NUMA` or `acq:numa`.

***NOTE.** Keep in mind that abbreviation rules change over time as new TDS models get introduced. Thus, for the most robust code, use the full spelling. Avoid using the command abbreviations.*

If you use the `HEADer` command to have command headers included as part of query responses, you can further control whether the returned headers are abbreviated or are full-length. The `VERBoSe` command lets you control this.

Concatenating Commands

You can concatenate any combination of set commands and queries using a semicolon (;). The digitizing oscilloscope executes concatenated commands in the order received.

When concatenating commands and queries, you must follow these rules:

1. Separate completely different headers by a semicolon and by the beginning colon on all commands but the first. For example, the commands `TRIGger:MODE NORMAl` and `ACQuire:NUMAVg 10` would be concatenated into a single command:

```
TRIGger:MODE NORMAl;:ACQuire:NUMAVg 10
```

2. If concatenated commands have headers that differ by only the last mnemonic, you can abbreviate the second command and eliminate the beginning colon. For example, you can concatenate the commands `ACQuire:MODE ENVeLope` and `ACQuire:NUMAVg 10` into a single command:

```
ACQuire:MODE ENVeLope; NUMAVg 10
```

The longer version works equally well:

```
ACQuire:MODE ENVeLope;:ACQuire:NUMAVg 10
```

3. Never precede a star (*) command with a colon:

```
ACQuire:MODE ENVeLope;*TRG
```

Any commands that follow will be processed as if the star command was not there so

```
ACQuire:MODE ENVeloPe;*TRG;NUMAVg 10
```

will set the acquisition mode to envelope and set the number of acquisitions for averaging to 10.

4. When you concatenate queries, the responses to all the queries are concatenated into a single response message. For example, if the display intensity for text is 80% and for the waveform it is 90%, the concatenated query

```
DISPlay:INTENsity:TEXT?;WAVEform?
```

will return either :DISPLAY:INTENSITY:TEXT 80;:DISPLAY:INTENSITY:WAVEFORM 90 if header is on or 80;90 if header is off.

5. Set commands and queries may be concatenated in the same message. For example,

```
ACQuire:MODE NORMAl;NUMAVg?;STATE?
```

is a valid message that sets the acquisition mode to normal. The message then queries the number of acquisitions for averaging and the acquisition state. Concatenated commands and queries are executed in the order received.

Here are some invalid concatenations:

- DISPlay:INTENsity:TEXT 80;ACQuire:NUMAVg 10
(no colon before ACQuire)
- DISPlay:INTENsity:TEXT 80;:WAVEform 90
(extra colon before WAVEform — could use DISPlay:INTENsity:WAVEform instead)
- DISPlay:INTENsity:TEXT 80;:*TRG
(colon before a star (*) command)
- APPMenu:LABel:BOTTOM1 "foo";LABel:BOTTOM2 "fee"
(levels of the mnemonics are different — either remove the second use of LABel: or place :APPMenu: in front of LABel:BOTTOM2)

Message Terminators

This manual uses <EOM> (End of message) to represent a message terminator.

Symbol	Meaning
<EOM>	Message terminator

The end-of-message terminator may be the END message (EOI asserted concurrently with the last data byte), the ASCII code for line feed (LF) sent as the last data byte, or both. The digitizing oscilloscope always terminates messages with LF and EOI. It allows white space before the terminator. For example, it allows CR LF.

Constructed Mnemonics

Some header mnemonics specify one of a range of mnemonics. For example, a channel mnemonic can be either CH1, CH2, CH3, or CH4. You use these mnemonics in the command just as you do any other mnemonic. For example, there is a CH1:VOLts command, and there is also a CH2:VOLts command. In the command descriptions, this list of choices is abbreviated as CH<x>.

Application Menu Mnemonics

When the application menu is displayed, commands may specify which menu button to use.

Symbol	Meaning
BOTTOM<x>	A main menu button selector; <x> is 1, 2, 3, 4, 5, 6, or 7. Main menu buttons are located along the bottom of the display and are numbered left to right, starting with 1.
RIGHT<x>	A side menu button selector; <x> is 1, 2, 3, 4, or 5. Side menu buttons are located along the right side of the display and are numbered top to bottom, starting with 1.

Cursor Position Mnemonics

When cursors are displayed, commands may specify which cursor of the pair to use.

Symbol	Meaning
POSITION<x>	A cursor selector; <x> is either 1 or 2.

Measurement Specifier Mnemonics

Commands can specify which measurement to set or query as a mnemonic in the header. Up to four automated measurements may be displayed with each displayed waveform. The displayed measurements are specified in this way:

Symbol	Meaning
MEAS<x>	A measurement specifier; <x> is either 1 [top], 2, 3, or 4[bottom].

Channel Mnemonics Commands specify the channel to use as a mnemonic in the header.

Symbol	Meaning
CH<x>	A channel specifier; <x> is either 1, 2, 3, or 4. For the TDS 410A, which has only two channels, <x> is either 1 or 2. For the TDS 520A, 524A, and 620A, CH3 and CH4 represent the front-panel inputs labeled AUX 1 and AUX 2 respectively.

Math Waveform Mnemonics Commands can specify the mathematical waveform to use as a mnemonic in the header.

Symbol	Meaning
MATH<x>	A math waveform specifier; <x> is 1, 2, or 3.

Reference Waveform Mnemonics Commands can specify the reference waveform to use as a mnemonic in the header.

Symbol	Meaning
REF<x>	A reference waveform specifier; <x> is either 1, 2, 3, or 4.

Waveform Mnemonics In some commands, you can specify a waveform regardless of whether it is a channel waveform, a math waveform, or a reference waveform. Specify such a waveform as follows:

Symbol	Meaning
<wfm>	Can be CH<x>, MATH<x> or REF<x>

Argument Types

The argument of a command may be in one of several forms. The individual descriptions of each command tell which argument types to use with that command.

Numeric Arguments Many digitizing oscilloscope commands require numeric arguments. The syntax shows the format that the digitizing oscilloscope returns in response to a query.

This is also the preferred format when sending the command to the digitizing oscilloscope though any of the formats will be accepted. This manual represents these arguments as follows:

Symbol	Meaning
<NR1>	Signed integer value
<NR2>	Floating point value without an exponent
<NR3>	Floating point value with an exponent

Most numeric arguments will be automatically forced to a valid setting, either by rounding or truncating, when an invalid number is input unless otherwise noted in the command description.

Quoted String Arguments

Some commands accept or return data in the form of a quoted string, which is simply a group of ASCII characters enclosed by a single quote (') or double quote ("). For example:

"this is a quoted string"

Symbol	Meaning
<QString>	Quoted string of ASCII text

Follow these rules when you use quoted strings:

1. A quoted string can include any character defined in the 7-bit ASCII character set. (See *Appendix A: Character Charts* on page A-2).

2. Use the same type of quote character to open and close the string:

"this is a valid string"

3. You can mix quotation marks within a string as long as you follow the previous rule:

"this is an 'acceptable' string"

4. You can include a quote character within a string simply by repeating the quote. For example,

"here is a "" mark"

5. Strings can have upper or lower case characters.
6. If you use a GPIB network, you cannot terminate a quoted string with the END message before the closing delimiter.

7. A carriage return or line feed imbedded in a quoted string does not terminate the string, but is treated as just another character in the string.
8. The maximum length of a quoted string returned from a query is 1000 characters.

Here are some invalid strings:

- "Invalid string argument'
(quotes are not of the same type)
- "test<EOI>"
(termination character is embedded in the string)

Block Arguments

Several digitizing oscilloscope commands use a block argument form:

Symbol	Meaning
<NZDig>	A nonzero digit character, in the range 1–9
<Dig>	A digit character, in the range 0–9
<DChar>	A character with the hex equivalent of 00 through FF hexadecimal (0 through 255 decimal)
<Block>	A block of data bytes, defined as: <Block> ::= { #<NZDig><Dig>[<Dig>...] [<DChar>...] #0[<DChar>...]<terminator> }

<NZDig> specifies the number of <Dig> elements that follow. Taken together, the <Dig> elements form a decimal integer that specifies how many <DChar> elements follow.

Figure 2–2 provides a diagram of block argument use.

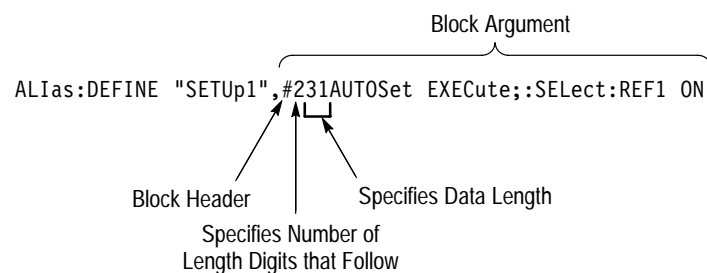

Figure 2–2: Block Argument Example

Syntax Diagrams

The syntax diagrams in this manual use the following symbols and notation:

- Circles and ovals contain literal elements. You must send most elements exactly as shown. The command mnemonics are shown in both upper and lower case to distinguish between complete and abbreviated spellings. These elements are not case sensitive. You can omit the lower case portion of the mnemonic.
- Boxes contain the defined elements described earlier in this section, such as <NR3> or <QString>.
- Elements are connected by arrows that show the allowed paths through the diagram and, thus, the orders in which you can send the elements. Parallel paths show that you must take one and only one of the paths. A path around a group of elements shows that those elements are optional. Loops show elements that you can repeat.

Figure 2–3 shows the structure of a few typical syntax diagrams.

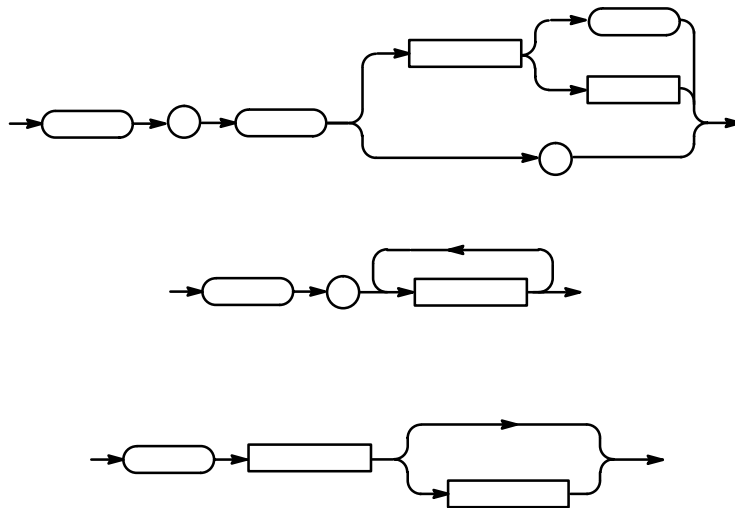

Figure 2–3: Typical Syntax Diagrams

Command Groups

This section lists TDS Family Oscilloscope commands in two ways. It first presents them by functional groups. It then lists them alphabetically. The functional group list starts below. The alphabetical list provides more detail on each command and starts on page 2–39.

The TDS Family Oscilloscope GPIB interface conforms to Tektronix standard codes and formats and IEEE Std 488.2–1987 except where noted.

Acquisition Commands

Acquisition commands affect waveform acquisition. These commands control mode, averaging, enveloping, and single-waveform acquisition. (Persistence controls are in the Display Commands section on page 2–14.) Table 2–4 lists these commands.

Table 2–4: Acquisition Commands

Header	Description
ACquire?	Return acquisition parameters
ACquire:AUTOsave (TDS 7XXA & some 6XXA)	Save waveforms to reference memory
ACquire:MODE	Acquisition mode
ACquire:NUMAcq?	Return # of acquisitions obtained
ACquire:NUMAVg	Number of acquisitions for average
ACquire:NUMEnv	Number of acquisitions for envelope
ACquire:REPET (TDS 4XXA, 5XXA, & 7XXA)	Repetitive acquisition mode
ACquire:STATE	Start or stop acquisition system
ACquire:STOPAfter	Acquisition control

Alias Commands

Alias commands let you define your own commands as a sequence of standard commands. This is useful when you use the same commands each time you perform a certain task, such as setting up measurements. Table 2–5 lists these commands.

Table 2–5: Alias Commands

Header	Description
ALIAS	Turn the alias state on and off
ALIAS:CATALOG?	Return a list of aliases
ALIAS:DEFINE	Create a new alias
ALIAS:DELETE	Remove an alias
ALIAS:DELETE:ALL	Remove all aliases
ALIAS:DELETE:NAME	Remove a named alias
ALIAS:STATE	Turn the alias state on and off

Application Menu Commands

Application menu commands let you define special-purpose menus. You can define labels for the main and side menus as well as a side menu title. You can display an Application menu by either pressing the front-panel **APPLICATION** button or sending the APPMenu ACTivate command. Table 2–6 lists these commands.

When the digitizing oscilloscope displays an Application menu and a user presses a front-panel button, the oscilloscope generates an event that tells the controller which button the user pressed. You can also set up the event reporting system so that it generates a Service Request when a user presses a menu button.

Table 2–6: Application Menu Commands

Header	Description
APPMenu	Display the application menu
APPMenu:LABEL	Return or remove all application menu button labels
APPMenu:LABEL:BOTTOM<x>	Label for a bottom menu button
APPMenu:LABEL:RIGHT<x>	Label for a side menu button
APPMenu:TITLE	Create a title for the application menu

Calibration and Diagnostic Commands

Calibration and Diagnostic commands let you start the self-calibration and diagnostic routines that are built-into the oscilloscope. The diagnostic test operation includes selecting the test sequence, executing the sequence, and viewing the results. Table 2–7 lists these commands.

Table 2–7: Calibration and Diagnostic Commands

Header	Description
*CAL?	Perform an internal self-calibration
DIAG:RESULT:FLAG?	Return diagnostic tests status
DIAG:RESULT:LOG?	Return diagnostic test sequence results
DIAG:SELEct:ACQUISition	Acquisition system diagnostic test sequence
DIAG:SELEct:ALL	Diagnostic test sequence for Acquisition, Processor, Display, and Front panel
DIAG:SELEct:CPU	Processor diagnostic test sequence
DIAG:SELEct:DISPlay	Display system diagnostic test sequence
DIAG:SELEct:FPANel	Front panel diagnostic test sequence
DIAG:STATE	Control of diagnostic tests

Cursor Commands

Cursor commands provide control over cursor (caliper) display and readout. Table 2–8 lists these commands.

Table 2–8: Cursor Commands

Header	Description
CURSor?	Return cursor settings
CURSor:FUNCTion	Cursors on or off; select cursor type
CURSor:HBArs?	Return H bar settings
CURSor:HBArs:DELTA?	Return distance between H bars
CURSor:HBArs:POSITION<x>	Position a horizontal cursor
CURSor:HBArs:POSITION<x>Pcnt (TDS 4XXA)	Position a horizontal cursor in units of % of vertical range
CURSor:HBArs:SELEct	Set which cursor the knob controls
CURSor:HBArs:UNIts	Set H bar units
CURSor:MODE	Set cursor tracking mode

Table 2–8: Cursor Commands (Cont.)

Header	Description
CURSor:PAIred	Positions paired cursors. Also, returns settings
CURSor:PAIred:HDELTA?	Return horizontal distance between 1 st and 2 nd paired cursors.
CURSor:PAIred:HPOS1?	Return horizontal position of 1 st paired cursor
CURSor:PAIred:HPOS2?	Return horizontal position of 2 nd paired cursor
CURSor:PAIred:POSITION<x>Pcnt (TDS 4XXA)	Position the horizontal paired cursor in units of % of record length
CURSor:PAIred:POSITION<x>	Set or return vbar position of the 1 st or 2 nd paired cursor
CURSor:PAIred:SElect	Select active paired cursor
CURSor:PAIred:UNIts	Set paired cursor units
CURSor:PAIred:VDELTA?	Return vertical distance between 1 st and 2 nd paired cursors
CURSor:VBArS	Position vertical bar cursors
CURSor:VBArS:DELTA?	Return horizontal distance between cursors
CURSor:VBArS:POSITION<x>	Position a vertical cursor
CURSor:VBArS:POSITION<x>Pcnt (TDS 4XXA)	Position a vertical cursor in units of % of record length
CURSor:VBArS:SElect	Set which cursor the knob controls
CURSor:VBArS:UNIts	Set vertical cursors to seconds, frequency, or to lines (with option 05 video on the TDS 5XXA, 6XXA, & 7XXA)
CURSor:VBArS:UNITSTring (TDS 4XXA)	Return unit string for the vertical bar cursor

Display Commands

Display commands let you change the graticule style, change the displayed intensities, display messages, and clear the menu. Table 2–9 lists these commands.

Table 2–9: Display Commands

Header	Description
CLEARMenu	Clear menus from display
DISplay?	Return display settings
DISplay:CLOCK	Control the display of the date/time stamp

Table 2-9: Display Commands (Cont.)

Header	Description
DISplay:COLOr:CONTRast (TDS 524A, 544A, 644A, 684A, & 7XXA)	Control collision contrast
DISplay:COLOr:MAP:<item>: BYCONTents (TDS 524A, 544A, 644A, 684A, & 7XXA)	Sets color for math or ref waveform to the color of the waveform content
DISplay:COLOr:MAP:<item>:TO (TDS 524A, 544A, 644A, 684A, & 7XXA)	Set color for math or ref waveform to specific color index
DISplay:COLOr:PALEtte:PERsistence (TDS 524A, 544A, 644A, 684A, & 7XXA)	Set current persistence palette to a preset persistence palette
DISplay:COLOr:PALEtte:REGular (TDS 524A, 544A, 644A, 684A, & 7XXA)	Set current palette to a preset palette
DISplay:COLOr:PALEtte:RESEtALL (TDS 524A, 544A, 644A, 684A, & 7XXA)	Reset all palettes to their factory default settings
DISplay:COLOr:PALEtte: <palette name>:RESEt (TDS 524A, 544A, 644A, 684A, & 7XXA)	Reset a selected palette to its factory default settings
DISplay:COLOr:PALEtte: <palette name>:<item name> (TDS 524A, 544A, 644A, 684A, & 7XXA)	Set the color of a selected item on a selected palette
DISplay:FILTer	Displayed data interpolation
DISplay:FORMat	YT or XY display
DISplay:GRAticule	Graticule style
DISplay:INSTavu:PERsistence (TDS 7XXA)	InstaVu persistence type – variable or infinite
DISplay:INSTavu:STYle (TDS 7XXA)	InstaVu waveform dots or vector style
DISplay:INSTavu:VARpersist (TDS 7XXA)	InstaVu variable persistence decay time
DISplay:INTENSITy?	Return intensity settings
DISplay:INTENSITy:CONTRast (TDS 4X0A, 520A, 540A, 620A, & 640A)	Waveform intensified zone brightness
DISplay:INTENSITy:OVERALL (TDS 4X0A, 520A, 540A, 620A, & 640A)	Main brightness
DISplay:INTENSITy:TEXT	Text brightness
DISplay:INTENSITy:WAVEform	Waveform brightness
DISplay:MODE	Normal or InstaVu display mode
DISplay:PERsistence	Variable persistence decay time

Table 2–9: Display Commands (Cont.)

Header	Description
DISplay:STYle	Waveform dots, vector, infinite persistence, or variable persistence
DISplay:TRIGBar	Control the display of the trigger bar/s on screen
DISplay:TRIGT	Control the display of the trigger indicator on screen
MESSage	Remove text from the message window
MESSage:BOX	Set size and location of message window
MESSage:SHOw	Remove and display text in the message window
MESSage:STATE	Control display of message window

File System Commands

File system commands help you use the built-in 3.5 inch floppy disk drive (available with the File System). Table 2–10 lists these commands.

Table 2–10: File System Commands

Header	Description
FILESystem:COpy	Copy file to new file
FILESystem:CWD	Set directory path
FILESystem:DELEte	Delete named file
FILESystem:DELWarn	Set front-panel delete warning
FILESystem:DIR	Make directory
FILESystem:FORMat	Format named drive
FILESystem:FREESpace	Return free space on current drive
FILESystem:MKDir	Make new directory
FILESystem:OVERWrite	Set file-overwrite protection
FILESystem:PRInt	Print file to port
FILESystem:REName	Assign new name to file
FILESystem:RMDir	Delete named directory

Hardcopy Commands

Hardcopy commands let you control the format of hardcopy output and the initiation and termination of hardcopies. Table 2–11 lists these commands.

Table 2–11: Hardcopy Commands

Header	Description
HARDCopy	Start or terminate hardcopy
HARDCopy:FILENAME (File System only)	Select file to send hardcopy data to
HARDCopy:FORMat	Hardcopy output format
HARDCopy:LAYout	Hardcopy orientation
HARDCopy:PALEtte (TDS 524A, 544A, 644A, 684A, 7XXA)	Select palette to use when making hardcopy
HARDCopy:PORT	Hardcopy port for output

Horizontal Commands

Horizontal commands control the time bases of the digitizing oscilloscope. You can set the time per division (or time per point) of both the main and delay time bases. You can also set the record lengths. Table 2–12 lists these commands.

You may substitute SECdiv for SCALE in the horizontal commands. This provides program compatibility with earlier models of Tektronix digitizing oscilloscopes.

Table 2–12: Horizontal Commands

Header	Description
HORizontal?	Return horizontal settings
HORizontal:CLOCK (TDS 4XXA only)	Enable internal or external clocks
HORizontal:CLOCK:MAXRate (TDS 4XXA only)	Set maximum external clock rate
HORizontal:DELay?	Return delay time base settings
HORizontal:DELay:MODE	Delay time base mode
HORizontal:DELay:SCALE	Delay time base time per division
HORizontal:DELay:SECdiv	Same as HORizontal:DELay:SCALE
HORizontal:DELay:TIME	Delay time

Table 2–12: Horizontal Commands (Cont.)

Header	Description
HORizontal:DELay:TIME?	Return delay time parameters
HORizontal:DELay:TIME:RUNSAfter	Time to wait in delay-runs-after-main mode
HORizontal:DELay:TIME:TRIGAAfter	Time to wait in delay-runs-after-trigger mode
HORizontal:FASTframe:COUNT (TDS 5XXA & 7XXA only)	Select FastFrame count
HORizontal:FASTframe:LENGth (TDS 5XXA & 7XXA only)	Select length of each FastFrame frame
HORizontal:FASTframe:POSition (TDS 5XXA & 7XXA only)	Select FastFrame frame to display
HORizontal:FASTframe:STATE (TDS 5XXA & 7XXA only)	Setup FastFrame acquisition
HORizontal:FITtoscreen (TDS 4XXA, 5XXA, 6XXA, & 7XXA)	Setup waveform compress
HORizontal:MAIn?	Return main time per division
HORizontal:MAIn:SCAle	Main time base time per division
HORizontal:MAIn:SECdiv	Same as HORizontal:MAIn:SCAle
HORizontal:MODE	Turn delay time base on or off
HORizontal:POSition	Portion of waveform to display
HORizontal:RECOrdlength	Number of points in waveform record
HORizontal:ROLL (TDS 4XXA only)	Set roll mode to auto or off
HORizontal:SCAle	Same as HORizontal:MAIn:SCAle
HORizontal:SECdiv	Same as HORizontal:MAIn:SCAle
HORizontal:TRIGger?	Return trigger position
HORizontal:TRIGger:POSition	Main time base trigger position

Limit Test Commands

The Limit Test commands let you automatically compare each incoming waveform against a template waveform. You set an envelope of limits around a waveform and let the digitizing oscilloscope find the waveforms that fall outside those limits. When it finds such a waveform, it can generate a hardcopy, ring a bell, stop and wait for your input, or any combination of these actions. Table 2–13 lists these commands.

Table 2–13: Limit Test Commands

Header	Description
LIMit:BELl	Ring bell when limit exceeded
LIMit:COMpare:CH<x>	Template to compare waveform to
LIMit:COMpare:MATH<x> (TDS 5XXA, 6XXA, & 7XXA)	Template to compare math waveform to
LIMit:HARDCopy	Make hardcopy when limit exceeded
LIMit:STATE	Turn limit testing on or off
LIMit:TEMLate	Template to compare waveform to
LIMit:TEMLate:DESTination	Reference storage for template waveform
LIMit:TEMLate:SOUrce	Template waveform source
LIMit:TEMLate:TOLerance: HORizontal	Tested waveform horizontal tolerance
LIMit:TEMLate:TOLerance:VERTical	Tested waveform vertical tolerance

Measurement Commands

Measurement commands control the automated measurement system. Table 2–14 lists these commands.

Up to four automated measurements can be displayed on the screen. In the commands, these four measurement readouts are named MEAS<x>, where <x> can be 1, 2, 3, or 4.

In addition to the four displayed measurements, the measurement commands let you specify a fifth measurement, IMMEd. The immediate measurement has no front-panel equivalent. Immediate measurements are never displayed. Because they are computed only when needed, immediate measurements slow the waveform update rate less than displayed measurements.

Whether you use displayed or immediate measurements, you use the VALue? query to obtain measurement results.

Measurement commands can set and query measurement parameters. You can assign some parameters, such as waveform sources, differently for each measurement readout. Other parameters, such as reference levels, have only one value, which applies to all measurements.

Table 2–14: Measurement Commands

Header	Description
MEASUrement?	Return all measurement parameters
MEASUrement:CLEARSnapshot	Take down measurement snapshot
MEASUrement:GATING	Set or query measurement gating
MEASUrement:IMMed?	Return immediate measurement parameters
MEASUrement:IMMed:DELay?	Return info on immediate delay measurement
MEASUrement:IMMed:DELay:DIRection	Search direction to use for delay measurements
MEASUrement:IMMed:DELay:EDGE1	Which waveform edge to use for delay measurements
MEASUrement:IMMed:DELay:EDGE2	Which waveform edge to use for delay measurements
MEASUrement:IMMed:SOURCE[1]	Channel to take measurement from
MEASUrement:IMMed:SOURCE2	Second channel to take measurement from (delay or "to" channel)
MEASUrement:IMMed:TYPe	The measurement to be taken
MEASUrement:IMMed:UNIts?	Return measurement units
MEASUrement:IMMed:VALue?	Return measurement result
MEASUrement:MEAS<x>?	Return parameters on measurement
MEASUrement:MEAS<x>:DELay?	Return delay measurement parameters
MEASUrement:MEAS<x>:DELay:DIRection	Search direction to use for delay measurements
MEASUrement:MEAS<x>:DELay:EDGE1	Which waveform edge to use for delay measurements
MEASUrement:MEAS<x>:DELay:EDGE2	Which waveform edge to use for delay measurements
MEASUrement:MEAS<x>:SOURCE[1]	Channel to take measurement from
MEASUrement:MEAS<x>:SOURCE2	Second channel to take measurement from (delay or "to" channel)
MEASUrement:MEAS<x>:STATE	Turn measurement display on or off
MEASUrement:MEAS<x>:TYPe	The measurement to be taken
MEASUrement:MEAS<x>:UNIts?	Return units to use for measurement

Table 2–14: Measurement Commands (Cont.)

Header	Description
MEASUrement:MEAS<x>:VALue?	Return measurement result
MEASUrement:MEthod	Method for calculating reference levels
MEASUrement:REFLevel?	Return reference levels
MEASUrement:REFLevel:ABSolute:HIGH	The top level for risetime (90% level)
MEASUrement:REFLevel:ABSolute:LOW	The low level for risetime (10% level)
MEASUrement:REFLevel:ABSolute:MID	Mid level for measurements
MEASUrement:REFLevel:ABSolute:MID2	Mid level for delay measurements
MEASUrement:REFLevel:MEthod	Method to assign HIGH and LOW levels: either % or absolute volts
MEASUrement:REFLevel:PERCent:HIGH	The top level for risetime (90% level)
MEASUrement:REFLevel:PERCent:LOW	The low level for risetime (10% level)
MEASUrement:REFLevel:PERCent:MID	Mid level for measurements
MEASUrement:REFLevel:PERCent:MID2	Mid level for delay measurements
MEASUrement:SNAPShot	Display measurement snapshot

Miscellaneous Commands

Miscellaneous commands do not fit into other categories. Table 2–15 lists these commands.

Several commands and queries are common to all 488.2–1987 devices on the GPIB bus. The 488.2–1987 standard defines them. They begin with a star (*) character.

Table 2–15: Miscellaneous Commands

Header	Description
AUTOSet	Automatic instrument setup
BEL1	Audio alert
*DATE	Set date
*DDT	Define group execute trigger (GET)
FACTory	Reset to factory default
HDR	Same as HEADER
HEADer	Return command header with query
*IDN?	Identification

Table 2–15: Miscellaneous Commands (Cont.)

Header	Description
*LRN?	Learn device setting
LOCK	Lock front panel (local lockout)
NEWpass	Change password for User Protected Data
PASSWord	Access to change User Protected Data
REM	No action; remark only
SET?	Same as *LRN?
TEKSecure	Initialize waveforms and setups
*TIME	Set time
*TRG	Perform Group Execute Trigger (GET)
*TST?	Self-test
UNLOCK	Unlock front panel (local lockout)
VERBose	Return full command name or minimum spellings with query

RS-232 Commands

RS-232 commands allow you to utilize the serial communications port (available with the RS-232/Centronics Hardcopy Interface). Table 2–16 lists these commands.

Table 2–16: RS-232 Commands

Header	Description
RS232?	Return RS-232 parameters
RS232:BAUd	Set baud rate
RS232:HARDFlagging	Set hard flagging
RS232:PARity	Set parity
RS232:SOFTFlagging	Set soft flagging
RS232:STOPBits	Set # of stop bits

Save and Recall Commands

Save and Recall commands allow you to store and retrieve internal waveforms and settings. When you “save a setup,” you save all the settings of the digitizing oscilloscope. When you then “recall a setup,” the digitizing oscilloscope restores

itself to the state it was in when you originally saved that setting. Table 2–17 lists these commands.

Table 2–17: Save and Recall Commands

Header	Description
ALLOcate?	Return number of allocated and unallocated data points
ALLOcate:WAVEFORM?	Return number of allocated data points
ALLOcate:WAVEFORM:FREE?	Return number of unallocated data points
ALLOcate:WAVEFORM:REF<x>?	Specify the number of allocated data points
DELEte:SETUp	Delete stored setup
DELEte:WAVEFORM	Delete stored waveform
*RCL	Recall settings
RECA11:SETUp	Recall saved instrument settings
RECA11:WAVEFORM (File System only)	Recall saved waveform
*SAV	Save settings
SAVe:SETUp	Save instrument settings
SAVe:WAVEFORM	Save waveform
SAVe:WAVEFORM:FILEFormat (TDS 4XXA & 7XXA only)	Specifies the file format for saved waveforms

Status and Error Commands

Table 2–18 lists the status and error commands the digitizing oscilloscope supports. These commands let you determine the status of the digitizing oscilloscope and control events.

Several commands and queries used with the digitizing oscilloscope are common to all devices on the GPIB bus. IEEE Std 488.2–1987 defines these commands and queries. They begin with an asterisk (*).

Table 2–18: Status and Error Commands

Header	Description
ALLEv?	Return all events
BUSY?	Return scope status
*CLS	Clear status

Table 2–18: Status and Error Commands (Cont.)

Header	Description
DESE	Device event status enable
*ESE	Event status enable
*ESR?	Return standard event status register
EVENT?	Return event code
EVMsg?	Return event code and message
EVQty?	Return number of events in queue
ID?	Identification
*OPC	Operation complete
*OPT?	Return installed options
*PSC	Power-on status clear
*PUD	Query or set User Protected Data
*RST	Reset
*SRE	Service request enable
*STB?	Read status byte
*WAI	Wait to continue

Trigger Commands

Trigger commands control all aspects of digitizing oscilloscope triggering. Table 2–19 lists these commands.

There are two triggers, main and delayed. Where appropriate, the command set has parallel constructions for each trigger.

You can set the main or delayed triggers to edge mode. Edge triggering lets you display a waveform at or near the point where the signal passes through a voltage level of your choosing.

You can also set TDS 5XXA, 6XXA, and 7XXA main triggers to pulse and logic modes. Pulse triggering lets the oscilloscope trigger whenever it detects a pulse of a certain width or height. Logic triggering lets you logically combine the signals on one or more channels. The digitizing oscilloscope then triggers when it detects a certain combination of signal levels.

Table 2–19: Trigger Commands

Header	Description
TRIGger	Force trigger event; Return parameters
TRIGger:DELay	Delay trigger level to 50%
TRIGger:DELay:BY	Delay by time or events
TRIGger:DELay:EDGE?	Return delay trigger parameters
TRIGger:DELay:EDGE:COUPling	Delay trigger coupling
TRIGger:DELay:EDGE:SLOpe	Delay trigger slope
TRIGger:DELay:EDGE:SOUrce	Delay trigger source
TRIGger:DELay:EVENTS?	Return delay trigger event parameters
TRIGger:DELay:EVENTS:COUNt	Delay by events count
TRIGger:DELay:LEVel	Delay trigger level
TRIGger:DELay:TIME	Time for delay by time
TRIGger:DELay:TYPe	Delay trigger, edge
TRIGger:MAIn	Main trigger level to 50%
TRIGger:MAIn:EDGE?	Return main edge trigger parameters
TRIGger:MAIn:EDGE:COUPling	Main trigger coupling
TRIGger:MAIn:EDGE:SLOpe	Main trigger slope
TRIGger:MAIn:EDGE:SOUrce	Main trigger source
TRIGger:MAIn:HOLDoFF?	Return main trigger holdoff value
TRIGger:MAIn:HOLDoFF:ACTUal? (TDS 684A & 7XXA)	Return main trigger holdoff value in seconds
TRIGger:MAIn:HOLdoFF:BY (TDS 684A & 7XXA)	Main trigger holdoff default
TRIGger:MAIn:HOLdoFF:TIME (TDS 684A & 7XXA)	Main trigger holdoff time
TRIGger:MAIn:HOLdoFF:VALue (Not in TDS 684A & 7XXA)	Main trigger holdoff value
TRIGger:MAIn:LEVel	Main trigger level
TRIGger:MAIn:LOGic? (TDS 5XXA, 6XXA, & 7XXA)	Returns main logic trigger parameters
TRIGger:MAIn:LOGic:CLAss (TDS 5XXA, 6XXA, & 7XXA)	Logic trigger input usage
TRIGger:MAIn:LOGic:FUNCTion (TDS 5XXA, 6XXA, & 7XXA)	Logic trigger input combining
TRIGger:MAIn:LOGic:INPut? (TDS 5XXA, 6XXA, & 7XXA)	Return main logic trigger input settings

Table 2-19: Trigger Commands (Cont.)

Header	Description
TRIGger:MAIn:LOGIc:INPut:CH<x> (TDS 5XXA, 6XXA, & 7XXA)	Logic trigger expected channel state
TRIGger:MAIn:LOGIc:PATtern: INPut:CH4 (TDS 5XXA, 6XXA, & 7XXA)	Logic trigger expected for channel 4 pattern class
TRIGger:MAIn:LOGIc:PATtern:WHEn (TDS 5XXA, 6XXA, & 7XXA)	Main logic pattern trigger condition
TRIGger:MAIn:LOGIc:PATtern: :WHEn:LESSLimit (TDS 5XXA, 6XXA, & 7XXA)	Maximum time the selected pattern may be true and still generate main logic pattern trigger
TRIGger:MAIn:LOGIc:PATtern: :WHEn:MORELimit (TDS 5XXA, 6XXA, & 7XXA)	Minimum time the selected pattern may be true and still generate main logic pattern trigger
TRIGger:MAIn:LOGIc:SETHold: CLOCK:EDGE (TDS 684A & 7XXA)	Clock edge polarity for setup and hold violation triggering
TRIGger:MAIn:LOGIc:SETHold: CLOCK:LEVel (TDS 684A & 7XXA)	Setup/Hold clock voltage trigger level.
TRIGger:MAIn:LOGIc:SETHold: CLOCK:SOUrce (TDS 684A & 7XXA)	Setup/Hold clock input source
TRIGger:MAIn:LOGIc:SETHold: DATA:LEVel (TDS 684A & 7XXA)	Setup/Hold data level
TRIGger:MAIn:LOGIc:SETHold: DATA:SOUrce (TDS 684A & 7XXA)	Setup/Hold data input data channel
TRIGger:MAIn:LOGIc:SETHold: HOLDTime (TDS 684A & 7XXA)	Setup/Hold trigger hold time
TRIGger:MAIn:LOGIc:SETHold: SETTime (TDS 684A & 7XXA)	Setup/Hold trigger set time
TRIGger:MAIn:LOGIc:STATE:INPut: CH4 (TDS 5XXA, 6XXA, & 7XXA)	Logic trigger expected for channel 4 state class
TRIGger:MAIn:LOGIc:STATE:WHEn (TDS 5XXA, 6XXA, & 7XXA)	When the logic trigger occurs (on true or false)
TRIGger:MAIn:LOGIc:THReshold? (TDS 5XXA, 6XXA, & 7XXA)	Return main logic thresholds

Table 2-19: Trigger Commands (Cont.)

Header	Description
TRIGger:MAIn:LOGIc:THReshoId: CH<x> (TDS 5XXA, 6XXA, & 7XXA)	Logic trigger thresholds
TRIGger:MAIn:LOGIc:WHEn (TDS 5XXA, 6XXA, & 7XXA)	Logic trigger on combination true or false
TRIGger:MAIn:MODE	Main trigger mode
TRIGger:MAIn:PULse? (TDS 5XXA, 6XXA, & 7XXA)	Returns pulse trigger parameters
TRIGger:MAIn:PULse:CLAss (TDS 5XXA, 6XXA, & 7XXA)	Pulse trigger class
TRIGger:MAIn:PULse:GLItch? (TDS 5XXA, 6XXA, & 7XXA)	Returns glitch trigger parameters
TRIGger:MAIn:PULse:GLItch:FILTer (TDS 5XXA, 6XXA, & 7XXA)	Glitch filter on and off
TRIGger:MAIn:PULse:GLItch: POLarity (TDS 5XXA, 6XXA, & 7XXA)	Glitch filter positive, negative, or both
TRIGger:MAIn:PULse:GLItch:WIDth (TDS 5XXA, 6XXA, & 7XXA)	Glitch trigger with differentiation between glitch and valid pulse
TRIGger:MAIn:PULse:RUNT? (TDS 5XXA, 6XXA, & 7XXA)	Return runt trigger parameters
TRIGger:MAIn:PULse:RUNT:POLarity (TDS 5XXA, 6XXA, & 7XXA)	Runt trigger positive, negative, or both
TRIGger:MAIn:PULse:RUNT:THReshoId? (TDS 5XXA, 6XXA, & 7XXA)	Return runt trigger thresholds
TRIGger:MAIn:PULse:RUNT: THReshoId:BOTh (TDS 684A & 7XXA)	Trigger level switching thresholds
TRIGger:MAIn:PULse:RUNT: THReshoId:HIGH (TDS 5XXA, 6XXA, & 7XXA)	Upper limit for runt pulse
TRIGger:MAIn:PULse:RUNT: THReshoId:LOW (TDS 5XXA, 6XXA, & 7XXA)	Lower limit for runt pulse
TRIGger:MAIn:PULse:RUNT:WHEn (TDS 684A & 7XXA)	Runt pulse width type to check for
TRIGger:MAIn:PULse:RUNT:WIDth (TDS 684A & 7XXA)	Minimum width for valid main pulse runt trigger
TRIGger:MAIn:PULse:SLEWRate: DELTATime (TDS 684A & 7XXA)	Slew rate trigger delta time

Table 2–19: Trigger Commands (Cont.)

Header	Description
TRIGger:MAIn:PULse:SLEWRate:POLarity (TDS 684A & 7XXA)	Slew rate trigger polarity
TRIGger:MAIn:PULse:SLEWRate:SLEWRate? (TDS 684A & 7XXA)	Return slew rate value
TRIGger:MAIn:PULse:SLEWRate:THReshoLd:BOTh (TDS 684A & 7XXA)	Upper and lower slew rate trigger thresholds
TRIGger:MAIn:PULse:SLEWRate:THReshoLd:HIGH (TDS 684A & 7XXA)	Upper limit for slew rate pulse
TRIGger:MAIn:PULse:SLEWRate:THReshoLd:LOW (TDS 684A & 7XXA)	Lower limit for slew rate pulse
TRIGger:MAIn:PULse:SLEWRate:WHEn (TDS 684A & 7XXA)	Slewing signal type to check for
TRIGger:MAIn:PULse:SOUrce (TDS 5XXA, 6XXA, & 7XXA)	Pulse trigger channel
TRIGger:MAIn:PULse:WIDth? (TDS 5XXA, 6XXA, & 7XXA)	Return trigger pulse width parameters
TRIGger:MAIn:PULse:WIDth:HIGHLimit (TDS 5XXA, 6XXA, & 7XXA)	Pulse trigger maximum pulse width
TRIGger:MAIn:PULse:WIDth:LOWLimit (TDS 5XXA, 6XXA, & 7XXA)	Pulse trigger minimum pulse width
TRIGger:MAIn:PULse:WIDth:POLarity (TDS 5XXA, 6XXA, & 7XXA)	Pulse trigger positive, negative, or both
TRIGger:MAIn:PULse:WIDth:WHEn (TDS 5XXA, 6XXA, & 7XXA)	Pulse trigger when pulse detected or when not detected
TRIGger:MAIn:TYPe	Set main trigger to edge, logic, pulse, or, with option 5, video type
TRIGger:MAIn:VIDeo? (TDS 5XXA, 6XXA, & 7XXA Option 05)	Return video trigger parameters
TRIGger:MAIn:VIDeo:BY (TDS 4XXA Option 05)	Set video trigger delay mode
TRIGger:MAIn:VIDeo:FIELD (Option 05)	Set video trigger field
TRIGger:MAIn:VIDeo:FIELDType (TDS 5XXA, 6XXA, & 7XXA Option 05)	Set video trigger field type

Table 2–19: Trigger Commands (Cont.)

Header	Description
TRIGger:MAIn:VIDeo:FLEXformat? (TDS 5XXA, 6XXA, & 7XXA Option 05)	Return FlexFormat parameters
TRIGger:MAIn:VIDeo:FLEXformat: FIELDRATE (TDS 5XXA, 6XXA, & 7XXA Option 05)	Set FlexFormat frames per second
TRIGger:MAIn:VIDeo:FLEXformat: FIELDS (TDS 5XXA, 6XXA, & 7XXA Option 05)	Set FlexFormat video fields
TRIGger:MAIn:VIDeo:FLEXformat: LINES (TDS 5XXA, 6XXA, & 7XXA Option 05)	Set FlexFormat lines in a frame
TRIGger:MAIn:VIDeo:FLEXformat: NEGSynchwidth (TDS 5XXA, 6XXA, & 7XXA Option 05)	Set FlexFormat negative sync width
TRIGger:MAIn:VIDeo:FLEXformat: V1StArttime (TDS 5XXA, 6XXA, & 7XXA Option 05)	Set time from positive (+) edge of tri-sync pulse for the last line in the selected field to the leading edge (-) of the first negative vertical sync pulse
TRIGger:MAIn:VIDeo:FLEXformat: V1StOptime (TDS 5XXA, 6XXA, & 7XXA Option 05)	Set time from positive edge of tri-sync pulse for the last line in the selected field (t_0) to trailing edge (positive) of the first negative vertical sync pulse
TRIGger:MAIn:VIDeo: FLEXformat:V2StArttime (TDS 5XXA, 6XXA, & 7XXA Option 05)	Set time from t_0 to the leading edge (positive) of the second vertical sync pulse
TRIGger:MAIn:VIDeo: FLEXformat:V2StOptime (TDS 5XXA, 6XXA, & 7XXA Option 05)	Set time from t_0 to trailing edge (positive) of the second negative vertical sync pulse
TRIGger:MAIn:VIDeo:HDTv) (TDS 5XXA, 6XXA, & 7XXA Option 05)	Select high definition TV format
TRIGger:MAIn:VIDeo:HOLdoff? (TDS 4XXA Option 5)	Return video trigger holdoff
TRIGger:MAIn:VIDeo:HOLdoff:VALue (TDS 4XXA Option 5)	Set video trigger holdoff value
TRIGger:MAIn:VIDeo:INTERLAcE (TDS 4XXA Option 5)	Select video trigger interlace format
TRIGger:MAIn:VIDeo:LINE (TDS 5XXA, 6XXA, & 7XXA Option 05)	Set video trigger delay in terms of a number of lines
TRIGger:MAIn:VIDeo:LINES (TDS 4XXA Option 5)	Set video trigger delay in terms of a number of lines
TRIGger:MAIn:VIDeo:NTSc (TDS 5XXA, 6XXA, & 7XXA Option 05)	Select color or mono NTSC

Table 2–19: Trigger Commands (Cont.)

Header	Description
TRIGger:MAIn:VIDeo:PAL (TDS 5XXA, 6XXA, & 7XXA Option 05)	Select color or mono PAL
TRIGger:MAIn:VIDeo:SCAN (TDS 4XXA Option 5)	Set video trigger scan rate
TRIGger:MAIn:VIDeo:SCANPeriod (TDS 4XXA Option 5)	Set video trigger scan period
TRIGger:MAIn:VIDeo:SOUrce Option 05	Select video trigger source
TRIGger:MAIn:VIDeo:STANdard (TDS 5XXA, 6XXA, & 7XXA Option 05)	Select video trigger standard
TRIGger:MAIn:VIDeo:SYNc (Option 05)	Select video trigger sync polarity
TRIGger:MAIn:VIDeo:SYStem (TDS 4XXA Option 5)	Select video trigger class
TRIGger:MAIn:VIDeo:TIME (TDS 4XXA Option 5)	Set video trigger delay time
TRIGger:STATE?	Return trigger system status

Vertical Commands

Vertical commands control the display of channels and of main and reference waveforms. Table 2–20 lists these commands.

The `SElect:<wfm>` command also selects the waveform many commands in other command groups use.

You may replace `VOLts` for `SCALe` in the vertical commands. This provides program compatibility with earlier models of Tektronix digitizing oscilloscopes.

Table 2–20: Vertical Commands

Header	Description
<code>CH<x>?</code>	Return vertical parameters
<code>CH<x>:BANdwidth</code>	Channel bandwidth
<code>CH<x>:COUPling</code>	Channel coupling
<code>CH<x>:IMPedance</code>	Channel impedance
<code>CH<x>:OFFSet</code>	Channel offset
<code>CH<x>:POSition</code>	Channel position
<code>CH<x>:PRObe?</code>	Return channel probe attenuation
<code>CH<x>:SCALe</code>	Channel volts per div
<code>CH<x>:VOLts</code>	Same as <code>CH<x>:SCALe</code>
<code>MATH<x>?</code>	Return math waveform definition
<code>MATH<x>:DEFine</code>	Define math waveform
<code>MATH<x>:NUMAVg</code> (TDS 5XXA, 6XXA, & 7XXA, some models require Option 2F)	Acquisition number at which to begin exponential averaging
<code>MATH<x>:PROCessing</code> (TDS 5XXA, 6XXA, & 7XXA, some models require Option 2F)	Math waveform averaging on or off
<code>SElect?</code>	Return selected waveform
<code>SElect:CONTR01</code>	Front-panel channel selector
<code>SElect:<wfm></code>	Set selected waveform

Waveform Commands

Waveform commands let you transfer waveform data points to and from the digitizing oscilloscope. Waveform data points are a collection of values that define a waveform. One data value usually represents one data point in the waveform record. When working with enveloped waveforms, each data value is either the min or max of a min/max pair. Before you transfer waveform data, you must specify the data format, record length, and waveform locations.

Table 2–21 lists these commands.

Waveform Data Formats

Acquired waveform data uses either one or two 8-bit data bytes to represent each data point. The number of bytes used depends on the acquisition mode specified when you acquired the data. Data acquired in **SAM**ple, **EN**velope, or **PEAK**detect mode uses one 8-bit byte per waveform data point. Data acquired in **HIRE**s or **AVER**age mode uses two 8-bit bytes per point. For more information on the acquisition modes see the **ACQUIRE: MODE** command on page 2–40.

The **DATA:WIDTH** command lets you specify the number of bytes per data point when transferring data to and from the digitizing oscilloscope. If you specify two bytes for data that uses only one, the least significant byte will be filled with zeros. If you specify one byte for data that uses two, the least significant byte will be ignored.

The digitizing oscilloscope can transfer waveform data in either ASCII or binary format. You specify the format with the **DATA:ENCdg** command.

ASCII data — is represented by signed integer values. The range of the values depends on the byte width specified. One byte wide data ranges from –128 to 127. Two byte wide data ranges from –32768 to 32767.

Each data value requires two to seven characters. This includes one to five characters to represent the value, another character, if the value is negative, to represent a minus sign, and a comma to separate the data points.

An example ASCII waveform data string may look like this:

```
CURVE<space>-110,-109,-110,-110,-109,-107,-109,-107,  
-106,-105,-103,-100,-97,-90,-84,-80
```

Use ASCII to obtain more human readable and easier to format output than binary. However, it may require more bytes to send the same values with ASCII than it does with binary. This may reduce transmission speeds.

Binary data — can be represented by signed integer or positive integer values. The range of the values depends on the byte width specified. When the byte width is one, signed integer data ranges from –128 to 127, and positive integer

values range from 0 to 255. When the byte width is two, the values range from -32768 to 32767.

The defined binary formats also specify the order in which the bytes are transferred. The four binary formats are RIBinary, RPBinary, SRIBinary, and SRPBinary.

RIBinary is signed integer where the most significant byte is transferred first, and RPBinary is positive integer where the most significant byte is transferred first. SRIBinary and SRPBinary correspond to RIBinary and RPBinary respectively but use a swapped byte order where the least significant byte is transferred first. The byte order is ignored when DATA:WIDTH is set to 1.

Waveform Data/Record Lengths

You can transfer multiple points for each waveform record. You can transfer a portion of the waveform or you can transfer the entire record. The DATA:START and DATA:STOP commands let you specify the first and last data points of the waveform record.

When transferring data into the digitizing oscilloscope, you must specify the location of the first data point within the waveform record. For example, when you set DATA:START to 1, data points will be stored starting with the first point in the record, and when you set DATA:START to 500, data will be stored starting at the 500th point in the record. The digitizing oscilloscope will ignore DATA:STOP when reading in data as it will stop reading data when it has no more data to read or when it has reached the specified record length.

When transferring data from the digitizing oscilloscope, you must specify the first and last data points in the waveform record. Setting DATA:START to 1 and DATA:STOP to the record length will always return the entire waveform. You can also use the vertical bar cursors to delimit the portion of the waveform that you want to transfer. DATA:START and DATA:STOP can then be set to the current cursor positions by sending the command DATA SNAp.

Waveform Data Locations and Memory Allocation

The DATA:SOURce command specifies the data location when transferring waveforms from the digitizing oscilloscope. You can transfer out multiple waveforms at one time by specifying more than one source.

You can transfer in to the digitizing oscilloscope only one waveform at a time. Waveforms sent to the oscilloscope are always stored in one of the four reference memory locations. You can specify the reference memory location with the DATA:DESTination command. You must define the memory size for the specified location before you store the data. The ALLOcate: WAVEFORM:REF<x> command lets you specify the memory size for each reference location.

Waveform Preamble

Each waveform that you transfer has an associated waveform preamble that contains information such as the horizontal scale, the vertical scale, and other settings in place when the waveform was created. Refer to the WFMPre commands starting on page 2–288 for more information about the waveform preamble.

Scaling Waveform Data

Once you transfer the waveform data to the controller, you can convert the data points into voltage values for analysis using information from the waveform preamble. The GETWFM program on the diskettes that come with this manual shows how you can scale data.

Transferring Waveform Data from the TDS Family Oscilloscope

You can transfer waveforms from the digitizing oscilloscope to an external controller using the following sequence:

1. Select the waveform source(s) using the DATA:SOURce command. If you want to transfer multiple waveforms, select more than one source.
2. Specify the waveform data format using DATA:ENCdg.
3. Specify the number of bytes per data point using DATA:WIDth.
4. Specify the portion of the waveform that you want to transfer using DATA:STARt and DATA:STOP.
5. Transfer waveform preamble information using WFMPRE? query.
6. Transfer waveform data from the digitizing oscilloscope using the CURVe? query.

Transferring Waveform Data to the TDS Family Oscilloscope

You can transfer waveform data to one of the four reference memory locations in the digitizing oscilloscope using the following sequence:

1. Specify waveform reference memory using DATA:DESTination.
2. Specify the memory size for the reference location specified in Step 1 using the ALLOcate:WAVEFORM:REF<x> command.
3. Specify the waveform data format using DATA:ENCdg.
4. Specify the number of bytes per data point using DATA:WIDth.
5. Specify first data point in the waveform record using DATA:STARt.
6. Transfer waveform preamble information using WFMPRe:<wfm>.
7. Transfer waveform data to the digitizing oscilloscope using CURVe.

Table 2–21: Waveform Commands

Header	Description
CURVe	Transfer waveform data
DATA	Waveform data format and location
DATA:DESTination	Destination for waveforms sent to digitizing oscilloscope
DATA:ENCdg	Waveform data encoding method
DATA:SOURce	Source of CURVe? data
DATA:START	Starting point in waveform transfer
DATA:STOP	Ending point in waveform transfer
DATA:TARget	Same as DATA:DESTination
DATA:WIDth	Byte width of waveform points
WAVFrm?	Return waveform preamble and data
WAVPre?	Return waveform format data
WFMPre:BIT_Nr	Preamble bit width of waveform points.
WFMPre:BN_Fmt	Preamble binary encoding type
WFMPre:BYT_Nr	Preamble byte width of waveform points
WFMPre:BYT_Or	Preamble byte order of waveform points
WFMPre:CRVchk	Preamble checksum of waveform points
WFMPre:ENCdg	Preamble encoding method
WFMPre:NR_Pt	Number of points in the curve
WFMPre:PT_Fmt	Format of curve points
WFMPre:PT_Off	Trigger position
WFMPre:WFId	Curve identifier
WFMPre:XINcr	Horizontal sampling interval
WFMPre:XMUIt	Horizontal scale factor
WFMPre:XOFF	Horizontal offset
WFMPre:XUNit	Horizontal units
WFMPre:XZEro	Horizontal origin offset
WFMPre:YMUIt	Vertical scale factor
WFMPre:YOFF	Vertical offset
WFMPre:YUNit	Vertical units
WFMPre:YZEro	Offset voltage
WFMPre:ZMUIt	Z-axis scale factor
WFMPre:ZOFF	Z-axis offset

Table 2–21: Waveform Commands (Cont.)

Header	Description
WFMPre:ZUNit	Z-axis units
WFMPre:ZZero	Z-axis origin offset
WFMPre:<wfm>:NR_Pt	Number of points in the curve
WFMPre:<wfm>:PT_Fmt	Format of curve points
WFMPre:<wfm>:PT_Off	Trigger position
WFMPre:<wfm>:WFIId	Curve identifier
WFMPre:<wfm>:XINcr	Horizontal sampling interval
WFMPre:<wfm>:XUNit	Horizontal units
WFMPre:<wfm>:YMU1t	Vertical scale factor
WFMPre:<wfm>:YOFF	Vertical offset
WFMPre:<wfm>:YUNit	Vertical units
WFMPre:<wfm>:YZero	Offset voltage

Zoom Commands

Zoom commands let you expand and position the waveform display horizontally and vertically without changing the time base or vertical settings. Table 2–22 lists these commands.

Table 2–22: Zoom Commands

Header	Description
ZOOM	Reset zoom parameters to defaults
ZOOM:DUAL (TDS 4XXA & 7XXA)	Turn dual zoom mode on and off
ZOOM:DUAL:OFFSET (TDS 4XXA & 7XXA)	Adjust the requested horizontal offset between the centers of the main and second zoom boxes.
ZOOM:GRATICULE (TDS 4XXA & 7XXA)	Select between the upper and lower graticule for use by the zoom preview state.
ZOOM:HORIZONTAL:LOCK	Horizontal zoom lock
ZOOM:HORIZONTAL:POSITION	Horizontal zoom position
ZOOM:HORIZONTAL:SCALE	Horizontal zoom scale
ZOOM:STATE	Turn zoom mode on or off
ZOOM:VERTICAL:POSITION	Vertical zoom position
ZOOM:VERTICAL:SCALE	Vertical zoom scale

Command Descriptions

You can use commands to either set instrument features or query instrument values. You can use some commands to do both, some to only set, and some to only query. This manual marks set only commands with the words “No Query Form” included with the command name. It marks query only commands with a question mark appended to the header, and includes the words “Query Only” in the command name.

This manual spells out headers, mnemonics, and arguments with the minimal spelling shown in upper case. For example, to use the abbreviated form of the ACQUIRE:MODE command just type ACQ:MOD.

ACQUIRE? (Query Only)

Returns all the current acquisition parameters.

Group Acquisition

Syntax ACQUIRE?

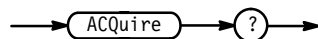

Examples ACQUIRE?
might return the string :ACQUIRE:STOPAFTER RUNSTOP;STATE 1;MODE SAMPLE;NUMENV 10;NUMAVG 16;REPET 1 for the current acquisition parameters.

ACQUIRE:AUTOSAVE

TDS 7XXA & Some 6XXA Only

Saves waveforms in reference memory when acquisition completes. This is equivalent to setting **Autosave Single Seq** in the Acquire menu and the corresponding side menu **Off** or **On** items.

When you start a Single Sequence with Autosave set to ON, the oscilloscope nulls out all existing reference waveforms. At the end of Single Sequence, the oscilloscope saves all displayed live channels to reference waveform memory. It saves references in the order Ch1 → Ref1, Ch2 → Ref2, Ch3 → Ref3, Ch4 → Ref4. The exact number of references saved may depend on the record length used.

Group Acquisition

Syntax ACQUIRE:AUTOSAVE { OFF | ON | <NR1> }
 ACQUIRE:AUTOSAVE?

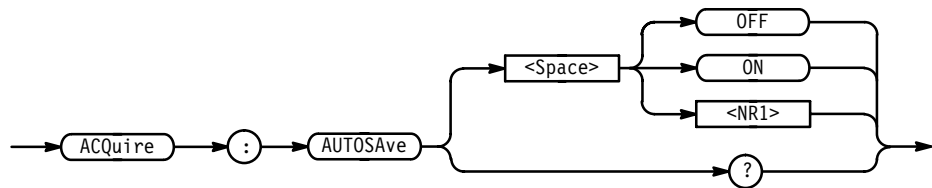

Arguments OFF or <NR1> = 0 turns repetitive mode off.
 ON or <NR1> ≠ 0 turns repetitive mode on.

Examples ACQUIRE:AUTOSAVE 1
 turns autosave mode on.
 ACQUIRE:AUTOSAVE OFF
 turns autosave mode off.
 ACQUIRE:AUTOSAVE?
 might return 1, indicating that autosave mode is on.

ACQUIRE:MODE

Sets or queries the acquisition mode of the digitizing oscilloscope. This affects all live waveforms. This command is equivalent to setting **Mode** in the Acquire menu.

Waveforms are the displayed data point values taken from acquisition intervals. Each acquisition interval represents a time duration set by the horizontal scale (time per division). The digitizing oscilloscope sampling system always samples at the maximum rate, and so an acquisition interval may include more than one sample.

The acquisition mode, which you set using this ACQUIRE:MODE command, determines how the final value of the acquisition interval is generated from the many data samples.

Group Acquisition

Related Commands ACQuire:NUMAVg, ACQuire:NUMENv, CURVe?, DATa:WIDth

Syntax For the TDS 4XXA, 5XXA & 7XXA:

ACQuire:MODe { SAMple | PEAKdetect | HIRes | AVErage | ENVelope }

For the TDS 6XXA:

ACQuire:MODe { SAMple | AVErage | ENVelope }

For all TDS:

ACQuire:MODe?

For the TDS 4XXA, 5XXA, & 7XXA:

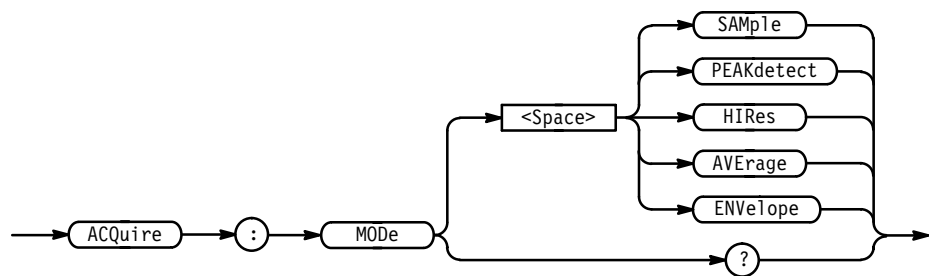

For the TDS 6XXA:

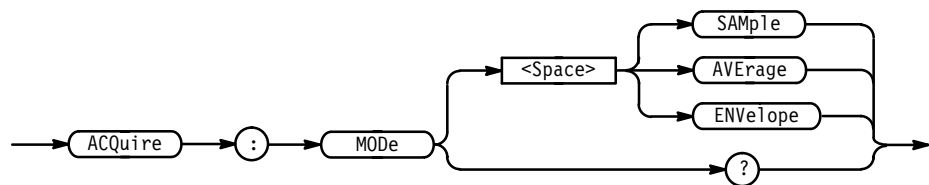

Arguments

SAMple specifies that the displayed data point value is simply the first sampled value that was taken during the acquisition interval. In sample mode, all waveform data has 8 bits of precision. You can request 16 bit data with a CURVe? query, but the lower-order 8 bits of data will be zero. SAMple is the default mode.

PEAKdetect (for the TDS 4XXA, 5XXA, & 7XXA) specifies the display of the high-low range of the samples taken from a single waveform acquisition. The high-low range is displayed as a vertical column that extends from the highest to the lowest value sampled during the acquisition interval. PEAKdetect mode can reveal the presence of aliasing or narrow spikes.

HIRes (for the TDS 4XXA, 5XXA, & 7XXA) specifies Hi Res mode, where the displayed data point value is the average of all the samples taken during the acquisition interval. This is a form of averaging, where the average comes from a single waveform acquisition. The number of samples taken during the acquisition interval determines the number of data values that compose the average.

AVerage specifies averaging mode, where the resulting waveform shows an average of SAMple data points from several separate waveform acquisitions. The number of waveform acquisitions that go into making up the average waveform is set or queried using the ACQUIRE:NUMAVg command.

ENvelope specifies envelope mode, where the resulting waveform shows the PEAKdetect range of data points from several separate waveform acquisitions. The number of waveform acquisitions that go into making up the envelope waveform is set or queried using the ACQUIRE:NUMENV command.

Examples ACQUIRE:MODE ENVELOPE
sets the acquisition mode to display a waveform that is an envelope of many individual waveform acquisitions.

ACQUIRE:MODE?
might return ENVELOPE.

ACQUIRE:NUMACq? (Query Only)

Indicates the number of acquisitions that have taken place since starting acquisition. This value is reset to zero when any Acquisition, Horizontal, or Vertical arguments that affect the waveform are modified. The maximum number of acquisitions that can be counted is $2^{30}-1$. Counting stops when this number is reached. This is the same value that is displayed in the upper center of the screen when the acquisition system is stopped.

Group Acquisition

Related Commands ACQUIRE:STATE

Syntax ACQUIRE:NUMACq?

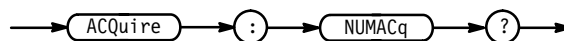

Related Commands <NR1>

Examples ACQUIRE:NUMACQ?
might return 350, indicating that 350 acquisitions took place since an ACQUIRE:STATE RUN command was executed.

ACQUIRE:NUMAVG

Sets the number of waveform acquisitions that make up an averaged waveform. This is equivalent to setting the **Average** count in the Acquisition Mode side menu.

Group Acquisition

Related Commands ACQUIRE:MODE

Syntax ACQUIRE:NUMAVG <NR1>
ACQUIRE:NUMAVG?

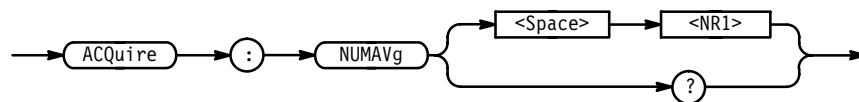

Arguments <NR1> is the number of waveform acquisitions, from 2 to 10,000.

Examples ACQUIRE:NUMAVG 10
specifies that an averaged waveform will show the result of combining 10 separately acquired waveforms.

ACQUIRE:NUMAVG?
might return 75, indicating that there are 75 acquisitions specified for averaging.

ACQUIRE:NUMENV

Sets the number of waveform acquisitions that make up an envelope waveform. This is equivalent to setting the **Envelope** count in the Acquisition Mode side menu.

Group Acquisition

Related Commands ACQUIRE:MODE

Syntax ACQuire:NUMEnv { <NR1> | INFInite }
 ACQuire:NUMEnv?

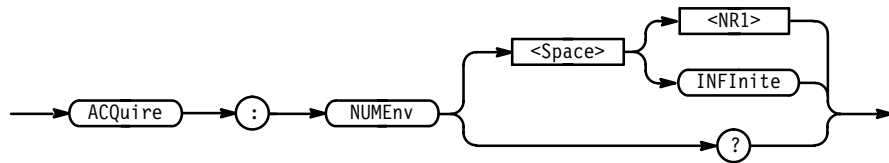

Arguments <NR1> \neq 0 is the number of waveform acquisitions, from 1 to 2000. The envelope will restart after the specified number of envelopes have been acquired or when the ACQuire:STATE RUN command is sent.

INFInite or <NR1> = 0 specifies continuous enveloping.

NOTE. If you set the acquisition system to single sequence, envelope mode, and set the number of envelopes to infinity, the digitizing oscilloscope will envelope a maximum of 2001 acquisitions.

Examples ACQUIRE:NUMENV 10
 specifies that an enveloped waveform will show the result of combining 10 separately acquired waveforms.

ACQUIRE:NUMENV?
 might return 0, indicating that acquisitions are acquired infinitely for enveloped waveforms.

ACQuire:REPET

TDS 4XXA, 5XXA, & 7XXA Only

Controls repetitive signal acquisition. This is equivalent to setting **Repetitive Signal** in the Acquire menu. When the digitizing oscilloscope is in real-time operation, this setting has no effect.

The ACQuire:REPET command specifies the behavior of the acquisition system during equivalent-time (ET) operation. When repetitive mode is on, the acquisition system will continue to acquire waveform data until the waveform record is filled with acquired data. When repetitive mode is off and you specify single acquisition operation, only some of the waveform data points will be set with acquired data, and the displayed waveform shows interpolated values for the unsampled data points.

Group	Acquisition
Related Commands	ACQuire:STATE, ACQuire:STOPAfter
Syntax	ACQuire:REPET { OFF ON <NR1> } ACQuire:REPET?

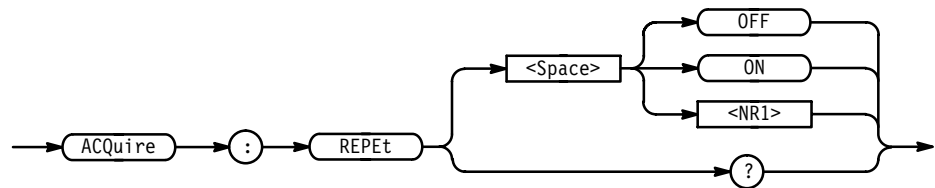

Arguments	OFF or <NR1> = 0 turns repetitive mode off. ON or <NR1> ≠ 0 turns repetitive mode on.
------------------	--

Examples	ACQUIRE:REPET 1 turns repetitive mode on. ACQUIRE:REPET OFF turns repetitive mode off. ACQUIRE:REPET? might return 1, indicating that repetitive signal acquisition mode is on.
-----------------	--

ACQuire:STATE

Starts or stops acquisitions. This is the equivalent of pressing the front-panel **RUN/STOP** button. If ACQuire:STOPAfter is set to SEQuence, other signal events may also stop acquisition.

Group	Acquisition
Related Commands	ACQuire:NUMAcq?, ACQuire:REPET, ACQuire:STOPAfter
Syntax	ACQuire:STATE { OFF ON RUN STOP <NR1> } ACQuire:STATE?

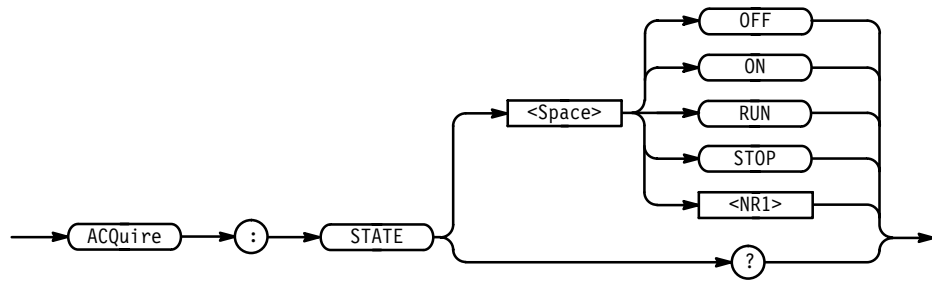

Arguments OFF or STOP or <NR1> = 0 stops acquisitions.
 ON or RUN or <NR1> ≠ 0 starts acquisition and display of waveforms. If the command was issued in the middle of an acquisition sequence (for instance averaging or enveloping), RUN restarts the sequence, discarding any data accumulated prior to the STOP. It also resets the number of acquisitions.

Examples ACQUIRE:STATE RUN
 starts acquisition of waveform data and resets the number of acquisitions count (NUMACQ) to zero.
 ACQUIRE:STATE?
 returns either 0 or 1, depending on whether the acquisition system is running.

ACQUIRE:STOPAfter

Tells the digitizing oscilloscope when to stop taking acquisitions. This is equivalent to setting **Stop After** in the Acquire menu.

Group Acquisition

Related Commands ACQUIRE:MODE, ACQUIRE:STATE, ACQUIRE:REPEt

Syntax ACQUIRE:STOPAfter { RUNSTop | SEQUence | LIMit }
 ACQUIRE:STOPAfter?

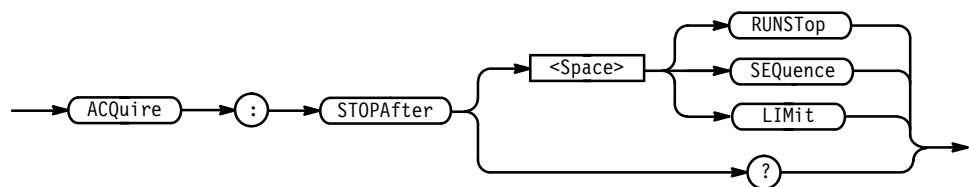

Arguments **RUNSTop** specifies that the run and stop state should be determined by the user pressing the front-panel **RUN/STOP** button.

SEQuence specifies “single sequence” operation, where the digitizing oscilloscope stops after it has acquired enough waveforms to satisfy the conditions of the acquisition mode. For example, if the acquisition mode is set to sample, and the horizontal scale is set to a speed that allows real-time operation, then the digitizing oscilloscope will stop after digitizing a waveform from a single trigger event. However, if the acquisition mode is set to average 100 waveforms, then the digitizing oscilloscope will stop only after all 100 waveforms have been acquired. The **ACQUIRE: STATE** command and the front-panel **RUN/STOP** button will also stop acquisition when the digitizing oscilloscope is in single sequence mode.

LIMit specifies the digitizing oscilloscope stops after the limit test condition is met.

***NOTE.** If you set the acquisition system to single sequence, envelope mode, and set the number of envelopes to infinity, the digitizing oscilloscope will envelope a maximum of 2001 acquisitions.*

Examples **ACQUIRE:STOPAFTER RUNSTop**
sets the oscilloscope to stop acquisition when the user presses the front-panel **RUN/STOP** button.

ACQUIRE:STOPAFTER?
might return **SEQUENCE**.

ALias

Turns command aliases on or off. This command is identical to the **ALias:STATE** command.

Group Alias

Syntax **ALias** { OFF | ON | <NR1> }
ALias?

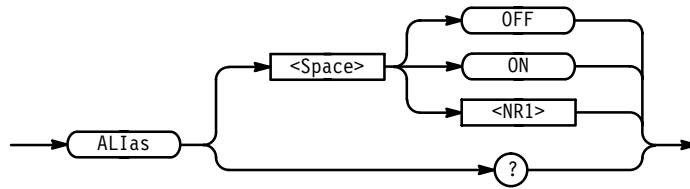

Arguments OFF or <NR1> = 0 turns alias expansion off. If a defined alias label is sent when ALIAS is OFF, an execution error (110, “Command header error”) will be generated.

ON or <NR1> ≠ 0 turns alias expansion on. When a defined alias is received, the specified command sequence is substituted for the alias and executed.

Examples ALIAS ON
turns the alias feature on.

ALIAS?
returns 1 when aliases are on.

ALIAS:CATALOG? (Query Only)

Returns a list of the currently defined alias labels, separated by commas. If no aliases are defined, the query returns the string "".

Group Alias

Syntax ALIAS:CATALOG?

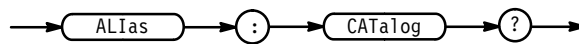

Returns <QString>[,<QString>...]

Examples ALIAS:CATALOG?
might return the string "SETUP1", "TESTMENU1", "DEFAULT", showing there are 3 aliases named SETUP1, TESTMENU1, and DEFAULT.

ALIAS:DEFINE

Assigns a sequence of program messages to an alias label. These messages are then substituted for the alias whenever it is received as a command or query

provided ALIAS:STATE has been turned ON. The ALIAS:DEFIne? query returns the definition of a selected alias.

Up to 10 aliases can be defined at one time. Aliases can be recursive. That is, aliases can include other aliases with up to 10 levels of recursion.

Group Alias

Syntax ALIAS:DEFIne <QString><Comma>{ <QString> | <Block> }
ALIAS:DEFIne? <QString>

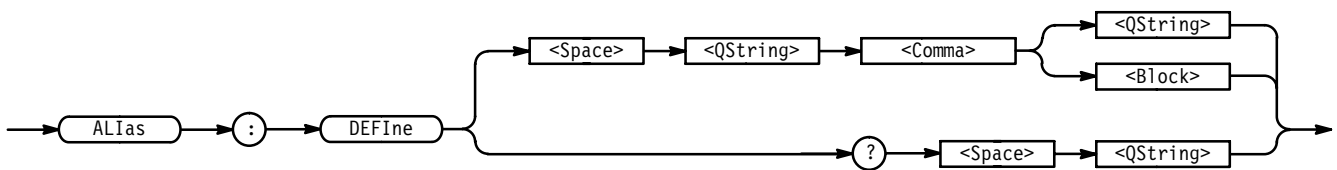

Arguments The first <QString> is the alias label. This label cannot be a command name. Labels must start with a letter, and can contain only letters, numbers, and underscores; other characters are not allowed. The label must be ≤12 characters.

The second <QString> or <Block> is a complete sequence of program messages. The messages can contain only valid commands that must be separated by semicolons and must follow all rules for concatenating commands (see page 2–4). The sequence must be ≤80 characters.

NOTE. Attempting to give two aliases the same name causes an execution error. To give a new alias the name of an existing alias, you must first delete the existing alias.

Examples ALIAS:DEFINE "ST1",":RECALL:SETUP 5;:AUTOSET EXECUTE;:SELECT:CH1 ON"
defines an alias named “ST1” that sets up the digitizing oscilloscope.

ALIAS:DEFINE? "ST1"
might return :ALIAS:DEFINE "ST1",#239:RECALL:SETUP 5;:AUTOSET EXECUTE;:SELECT:CH1 ON

ALias:DELEte (No Query Form)

Removes a specified alias. This command is identical to ALias:DELEte:NAME.

Group Alias

Syntax ALias:DELEte <QString>

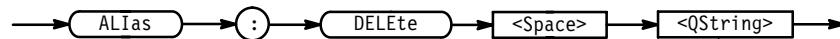

Arguments <QString> is the name of the alias you want to remove. Using ALias:DELEte without specifying an alias causes an execution error. <QString> must be a previously defined alias.

Examples ALIAS:DELETE "SETUP1"
deletes the alias named SETUP1.

ALias:DELEte:ALL (No Query Form)

Deletes all existing aliases.

Group Alias

Syntax ALias:DELEte:ALL



Examples ALIAS:DELETE:ALL
deletes all aliases.

ALias:DELEte:NAME (No Query Form)

Removes a specified alias. This command is identical to ALias:DELEte.

Group Alias

Syntax ALias:DELEte:NAME <QString>

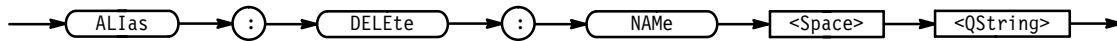

Arguments <QString> is the name of the alias to remove. Using ALIAS:DELETE:NAME without specifying an alias causes an execution error. <QString> must be a previously defined alias.

Examples ALIAS:DELETE:NAME "STARTUP"
deletes the alias named STARTUP.

ALIAS:STATE

Turns aliases on or off. This command is identical to the ALIAS command.

Group Alias

Syntax ALIAS:STATE { OFF | ON | <NR1> }
ALIAS:STATE?

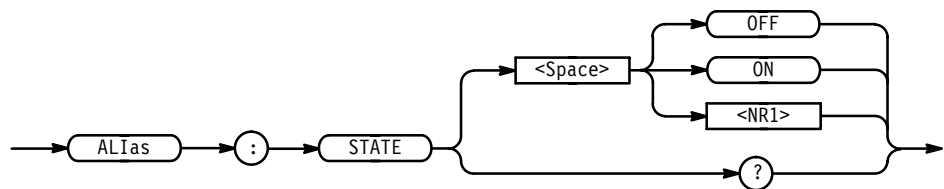

Arguments OFF or <NR1> = 0 turns alias expansion off. If a defined alias is sent when ALIAS:STATE is OFF, a command error (102) will be generated.

ON or <NR1> ≠ 0 turns alias expansion on. When a defined alias is received, the specified command sequence is substituted for the alias and executed.

Examples ALIAS:STATE OFF
turns the command alias feature off.

ALIAS:STATE?
returns 0 when alias mode is off.

ALLEV? (Query Only)

Causes the digitizing oscilloscope to return all events and their messages, and removes the returned events from the Event Queue. The messages are separated

by commas. Use the *ESR? query to enable the events to be returned. For a complete discussion of the use of these registers, see page 3–1. This command is similar to repeatedly sending *EVMsg? queries to the instrument.

Group Status and error

Related Commands *CLS, DESE, *ESE, *ESR?, EVENT?, EVMsg?, EVQTY, *SRE, *STB?

Syntax ALLEv?



Returns The event code and message in the following format:

<Event Code><Comma><QString>[<Comma><Event Code><Comma><QString>...]

<QString> ::= <Message>; [<Command>]

<Command> is the command that caused the error and may be returned when a command error is detected by the digitizing oscilloscope. As much of the command will be returned as possible without exceeding the 60 character limit of the <Message> and <Command> strings combined. The command string is right-justified.

Examples ALLEV?

might return the string :ALLEV 2225,"Measurement error, No waveform to measure; ",420,"Query UNTERMINATED; ".

ALLOcate? (Query Only)

Returns the number of data points allocated for all four reference memory locations.

Group Save and Recall

Syntax ALLOcate?

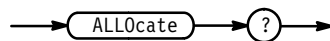

Examples ALLOCATE?
 might return :ALLOCATE:WAVEFORM:REF1 50000;REF2 0;REF3 0; REF4 0;, indicating that all 50000 data points are allocated to reference memory location 1.

ALLOcate:WAVEform? (Query Only)

Returns the number of data points allocated for all four reference memory locations.

Group Save and Recall

Syntax ALLOcate:WAVEform?

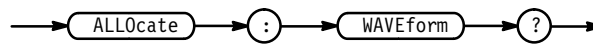

Examples ALLOCATE?
 might return :ALLOCATE:WAVEFORM:REF1 500;REF2 500;REF3 500; REF4 0;, indicating that 500 data points are allocated to each of the first three reference memory locations.

ALLOcate:WAVEform:FREE? (Query Only)

Returns the approximate number of data points that have not been allocated.

Group Save and Recall

Syntax ALLOcate:WAVEform:FREE?

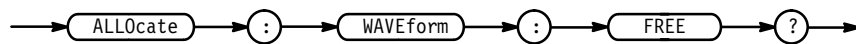

Returns <NR1> is the approximate number of data points available.

Examples ALLOCATE:WAVEFORM:FREE?
 might return 520 indicating that there are approximately 500 data points available for allocation. The extra 20 are used for administration purposes.

ALLOcate:WAVEform:REF<x>

Sets or queries the number of waveform data points for the specified reference location. If an attempt is made to allocate memory when it is not available, an execution error is generated and the memory is not allocated.

Group Save and Recall

Syntax ALLOcate:WAVEform:REF<x> <NR1>

ALLOcate:WAVEform:REF<x>?



Arguments <NR1> = 0 is returned when the reference location is empty.

<NR1> ≠ 0 specifies the number of data points. Table 2–23 shows the number of data points supported for reference locations by TDS model. In the TDS 5XXA and 6XXA, all invalid values less than the maximum will be forced to the next highest valid value, and those higher than the maximum will be forced to the maximum. For example, 15002 points on a TDS 544A with option 1M will allocate 50000 points of data for the reference. No complete references are stored for 500000 data points in the TDS 7XXA.

Table 2–23: Waveform Data Points Supported for Reference Locations

Configuration	TDS 410A, TDS 420A, TDS 460A	TDS 520A, TDS 524A, TDS 540A, TDS 544A	TDS 620A, TDS 640A, TDS 644A	TDS 684A	TDS 744A, TDS 784A
Standard	500, 1000, 2500, 5000, 15000, 30000 (4 refs)	500, 1000, 2500, 5000, 15000	500, 1000, 2000	500, 1000, 2500, 5000, 15000	500, 1000, 2500, 5000, 15000, 50000 (4 refs)
Option 1M	60000 (2 refs), 120000 (1 ref)	50000			75000 (3 refs), 100000 (2 refs), 130000 (2 refs), 250000 (1 ref) 500000 (no complete refs)

Examples ALLOCATE:WAVEFORM:REF2 1000
reserves 1,000 data points for REF2.

ALLOCATE:WAVEFORM:REF1?
might return 500

APPMenu

Displays the user-definable Application menu, and the query returns the current Application menu labels and title. This is equivalent to pressing the front-panel **APPLICATION** button.

Group Application Menu

Related Commands CLEARMenu, *ESR, EVENT?

Syntax APPMenu ACTivate
APPMenu?

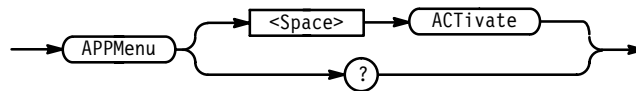

Arguments ACTivate displays the Application menu. Use the CLEARMenu command to deactivate the Application menu.

Once the Application menu is activated, whenever a front-panel menu button is pressed an event is generated that tells which button was pressed. See page 3–17 for event codes.

Menu button presses will also generate Service Requests when the URQ bit is enabled in DESER and ESER and the ESB bit is enabled in SRER. See page 3–1 for a complete discussion of the use of these registers.

Examples APPMENU ACTIVATE
displays the application menu.

APPMenu:LABel

Removes all user-defined Application menu button labels from the display. The APPMenu:LABel? query returns all the current label settings.

Group Application Menu

Syntax APPMenu:LABel CLear
APPMenu:LABel?

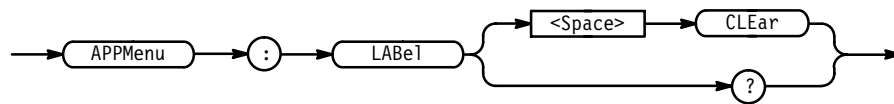

Arguments CLear removes the main and side menu button labels from the display. Front-panel bezel button presses will continue to generate events.

Examples APPMENU:LABEL CLEAR
clears the user-defined menu labels from the display.

APPMenu:LABel:BOTTOM<x>

Defines a label for the main menu button that is specified by <x>. Main menu buttons are located along the bottom of the display, and are numbered from 1 to 7 starting with the left-most button.

Group Application Menu

Syntax APPMenu:LABel:BOTTOM<x> <QString>
APPMenu:LABel:BOTTOM<x>?

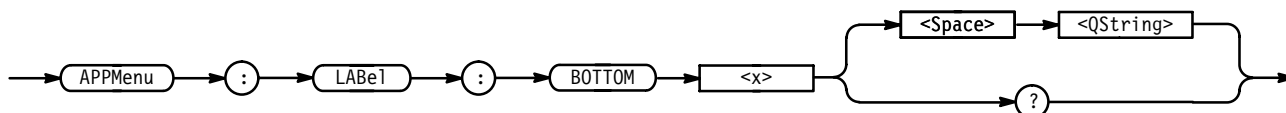

Arguments <QString> is the menu button label and can include any of the characters shown in the TDS Character Chart in Appendix A. The maximum length of the label is 1000 characters. The TDS displays the label in the area above the specified main menu button.

The TDS displays the label on a single line and centers it, both vertically and horizontally, within the label area. You can embed a line feed character in the string to position the label on multiple lines. You can also use white space tab characters to position the label within a line.

You can send a tab by transmitting a tab character (decimal 9) followed by two characters representing the most significant eight bits followed by the least significant eight bits of a 16-bit number. The number specifies the pixel column relative to the left margin of the label area. For example, to tab to pixel 13, send TAB (decimal 9), NUL (decimal 0), and CR (decimal 13).

The ESC @ character turns reverse video on and off, and can be embedded in the label string. The first ESC @ character displays all text following the ESC @ in reverse video until another ESC @ character is found in the string.

NOTE. *The use of any undocumented codes may produce unpredictable results.*

The label area is 45 pixels high and 90 pixels wide. The length of the label that fits in the label area depends on the contents of the label, because the width of characters varies. The label area is about 10 characters wide and 3 lines high. For a complete list of character widths in pixels, see Table A-1 on page A-1.

If the label exceeds the limits of the label area, either horizontally or vertically, the portion of the label that exceeds the limits will not be displayed. Note: the label itself is not altered. The entire label can be returned as a query response regardless of what is displayed.

Examples APPMENU:LABEL:BOTTOM3 "SETUP1"
 assigns the label "SETUP1" to the third main menu button.

APPMenu:LABel:RIGHT<x>

Defines a label for the side menu button that is specified by <x>. Side menu buttons are located on the right side of the display, and are numbered from 1 to 5 starting with the top-most button.

Group Application Menu

Syntax APPMenu:LABel:RIGHT<x> <QString>

APPMenu:LABel:RIGHT<x>?

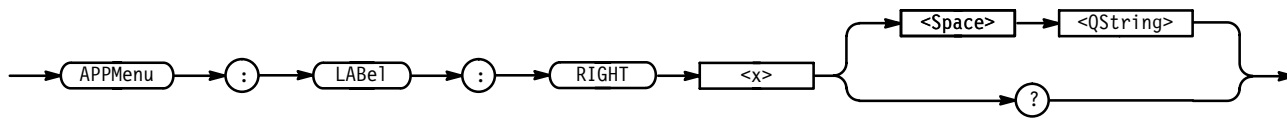

Arguments <QString> is the menu button label and can include any of the characters shown in the TDS Character Chart in Appendix A. The maximum length of the label is 1000 characters. The label is displayed in the area to the left of the specified side menu button. Refer to the APPMenu:LABEL:BOTTOM<x> command on page 2–57 for more information on defining menu labels.

The label area is 72 pixels high and 112 pixels wide. The length of the label that fits in the label area depends on the contents of the label, because the width of characters varies. The label area is about 12 characters wide and 4 lines high. For a complete list of character widths in pixels, see Table A–1 on page A–1.

Examples APPMENU:LABEL:RIGHT1 "TEST ON"
displays the label “TEST ON” next to the top side menu button.

APPMenu:TITLe

Sets or queries the user-defined application menu title. The title is displayed above the side menu.

Group Application Menu

Related Commands APPMenu, APPMenu:LABel

Syntax APPMenu:TITLe <QString>
APPMenu:TITLe?

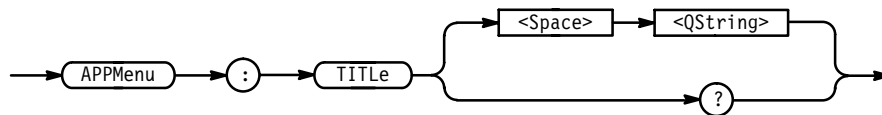

Arguments <QString> is the side menu title and can include any of the characters shown in the TDS Character Chart in Appendix A. The maximum length of the title is 1000 characters. The APPMenu:LABel:BOTTOM<x> command on page 2–57 provides information on defining menu labels.

The label area is 40 pixels high and 112 pixels wide. The length of the label that fits in the label area depends on the contents of the label, because the width of

characters varies. The label area is about 12 characters wide and 4 lines high. For a complete list of character widths in pixels, see Table A-1 on page A-1.

Examples APPMENU:TITLE "Custom Menu"
displays the title "Custom Menu" on the screen.

APPMENU:TITLE?
might return "Test Setup" for the current application menu title.

AUTOSet (No Query Form)

Causes the digitizing oscilloscope to adjust its vertical, horizontal, and trigger controls to provide a stable display of the selected waveform. This is equivalent to pressing the front-panel **AUTOSET** button. For a detailed description of the autoset function, see Autoset in the Reference section of the User Manual for your instrument.

Group Miscellaneous

Syntax AUTOSet EXECute

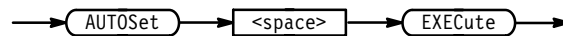

Arguments EXECute autosets the displayed waveform.

BELI (No Query Form)

Beeps the audio indicator of the digitizing oscilloscope.

Group Miscellaneous

Syntax BELI

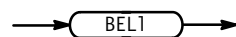

Examples BELL
rings the bell.

BUSY? (Query Only)

Returns the status of the digitizing oscilloscope. This command allows you to synchronize the operation of the digitizing oscilloscope with your application program. Synchronization methods are described on page 3–7.

Group Status and error

Related Commands *OPC, *WAI

Syntax BUSY?



Returns <NR1> = 0 means that the digitizing oscilloscope is not busy processing a command whose execution time is extensive. These commands are listed in Table 2–24.

<NR1> = 1 means that the digitizing oscilloscope is busy processing one of the commands listed in Table 2–24.

Table 2–24: Commands that Affect BUSY? Response

Operation	Command
Single sequence acquisition	ACQuire:STATE ON or ACQuire:STATE RUN (when ACQuire:STOPAfter is set to SEQuence)
Hardcopy output	HARDCopy START

Examples BUSY?
might return 1, indicating that the instrument is busy.

*CAL? (Query Only)

Instructs the digitizing oscilloscope to perform an internal self-calibration and return its calibration status.

NOTE. The self-calibration can take several minutes to respond. No other commands will be executed until calibration is complete.

Group Calibration and Diagnostic

Syntax *CAL?



Returns <NR1> = 0 indicates that the calibration completed without any errors detected.
<NR1> ≠ 0 indicates that the calibration did not complete successfully.

Examples *CAL?
performs an internal self-calibration and might return 0 to indicate that the calibration was successful.

CH<x>? (Query Only)

Returns the vertical parameters. Because CH<x>:SCALE and CH<x>:VOLts are identical, only CH<x>:SCALE is returned.

Group Vertical

Syntax CH<x>?



Examples CH1?
might return the string :CH1:SCALE 10.0E-3;POSITION 0.0E+0;
OFFSET 0.0E+0;COUPLING DC;IMPEDANCE MEG;BANDWIDTH FULL for channel 1.

CH<x>:BANdwidth

Sets or queries the bandwidth setting of the specified channel. This is equivalent to setting **Bandwidth** in the Vertical menu.

Group Vertical

Syntax CH<x>:BANdwidth { TWEnty | HUNdred (All TDS except 684A & 7XXA) | TWofifty (TDS 684A & 7XXA) | FULL }

CH<x>:BANdwidth?

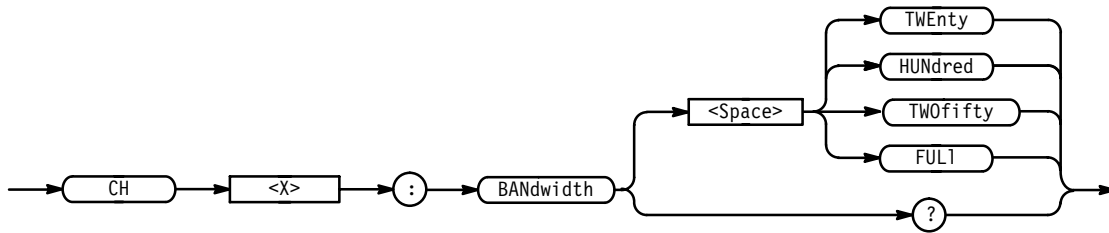

Arguments

TWEnty sets the channel bandwidth to 20 MHz.

HUNdred sets the channel bandwidth to 100 MHz (All TDS except 684A & 7XXA).

TWOfifty sets the channel bandwidth to 250 MHz (TDS 684A & 7XXA only).

FUL1 sets the channel bandwidth to the full bandwidth of the digitizing oscilloscope.

Examples

CH2: BANDWIDTH TWENTY
sets the bandwidth of channel 2 to 20 MHz.

CH1: BANDWIDTH?
might return FULL, which indicates that there is no bandwidth limiting on channel 1.

CH<x>:COUPling

Sets or queries the input attenuator coupling setting of the specified channel. This is equivalent to setting **Coupling** in the Vertical menu.

Group Vertical

Related Commands CH<x>:IMPedance

Syntax CH<x>:COUPling { AC | DC | GND }
CH<x>:COUPling?

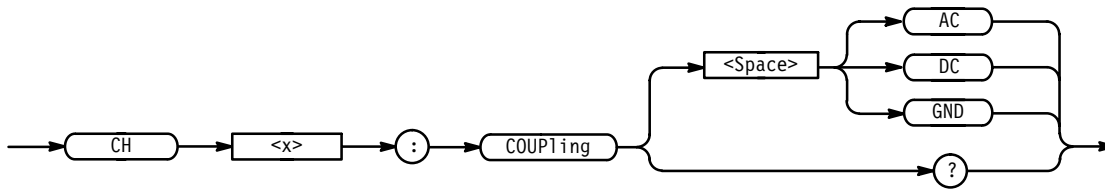

Arguments AC sets the specified channel to AC coupling.
 DC sets the specified channel to DC coupling.
 GND sets the specified channel to ground. Only a flat ground-level waveform will be displayed.

Examples CH1:COUPLING AC
 establishes AC coupling on channel 1.
 CH3:COUPLING?
 might return DC, indicating that channel 3 is set to DC coupling.

CH<x>:IMPedance

Sets or queries the impedance setting at the specified input channel. This is equivalent to setting the **Impedance** in the Ch<x> Coupling Impedance side menu.

TDS 684A and 7XXA only: When you attach an active 50 Ω probe to an input channel of the TDS 684A or 7XXA, the oscilloscope reduces the maximum vertical scale from 10 V to 1 V per division. For example, an active 10X probe would provide 10 V per division and a passive 10X probe would provide 100 V per division.

Group Vertical

Related Commands CH<x>:COUPLing

Syntax CH<x>:IMPedance { FIFty | MEG }
 CH<x>:IMPedance?

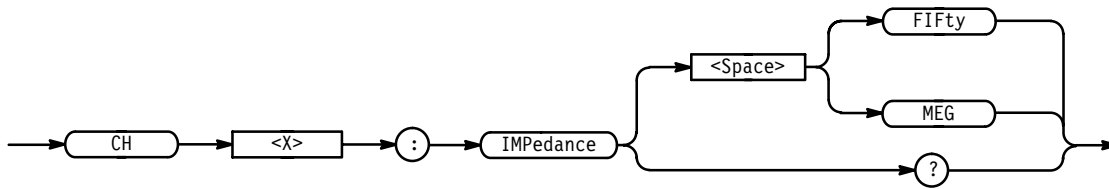

Arguments FIFty sets the specified channel to 50 Ω impedance.

MEG sets the specified channel to 1 M Ω impedance.

Examples CH1:IMPEDANCE FIFty
establishes 50 Ω impedance on channel 1.

CH3:IMPEDANCE?
might return MEG, indicating that channel 3 is set to 1 M Ω impedance.

CH<x>:OFFSet

Sets or queries the offset, in volts, that is subtracted from the specified input channel before it is acquired. The greater the offset, the lower on the display the waveform appears. This is equivalent to setting **Offset** in the Vertical menu.

Group Vertical

Related Commands CH<x>:POSition

Syntax CH<x>:OFFSet <NR3>

CH<x>:OFFSet?

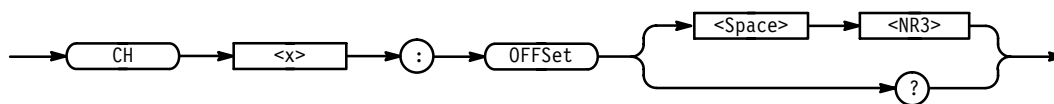

Arguments <NR3> is the desired offset in volts. The range is dependent on the scale and the probe attenuation factor. The offset ranges are shown below.

Table 2–25: Offset Ranges for the TDS 4XXA, 54XA, 6XXA, & 7XXA (All Channels) and the TDS 520A & 524A (Channel 1 & Channel 2) using a 1x Probe

CH<x>:SCALE	OFFSet Range
1 mV/div – 99.5 mV/div	±1 V
100 mV/div – 995 mV/div	±10 V
1 V/div – 10 V/div	±100 V

Table 2–26: Offset Ranges for the TDS 520A & 524A (Aux 1 & Aux 2) using a 1x Probe

CH<x>:SCALE	OFFSet Range
50 mV/div & 100 mV/div	±.5 V
500 mV/div & 1 V/div	±5.0 V
5 V/div & 10 V/div	±50 V

Examples CH1:OFFSET 0.5E+00
lowers the channel 1 displayed waveform by 0.5 volts.

CH1:OFFSET?
might return 500.0E–3, indicating that the current channel 1 offset is 0.5 volts.

CH<x>:POSITION

Sets or queries the vertical position of the specified channel. The position value is applied to the signal before digitization. This is equivalent to setting **Position** in the Vertical menu or adjusting the front-panel **Vertical Position** knob.

Group Vertical

Related Commands CH<x>:OFFSet

Syntax CH<x>:POSITION <NR3>
CH<x>:POSITION?

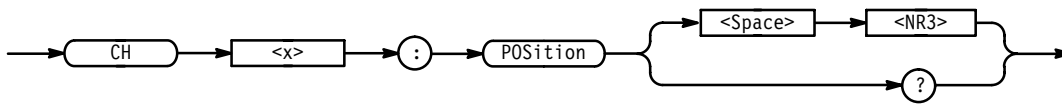

Arguments <NR3> is the desired position, in divisions from the center graticule. The range is ± 5 divisions.

Examples CH2:POSITION 1.3E+00
positions the channel 2 input signal 1.3 divisions above the center of the display.

CH1:POSITION?
might return $-1.3E+00$, indicating that the current position of channel 1 is at -1.3 divisions.

CH<x>:PRObe? (Query Only)

Returns the attenuation factor of the probe that is attached to the specified channel.

Group Vertical

Syntax CH<x>:PRObe?

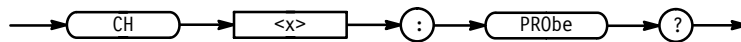

Returns <NR3>

Examples CH4:PROBE?
might return $100.0E-3$ for a 10x probe.

CH<x>:SCALE

Sets or queries the vertical gain of the specified channel. This is equivalent to setting **Fine Scale** in the Vertical menu or adjusting the front-panel **Vertical SCALE** knob.

Group Vertical

Related Commands CH1:VOLts

Syntax CH<x>:SCALE <NR3>

CH<x>:SCALE?

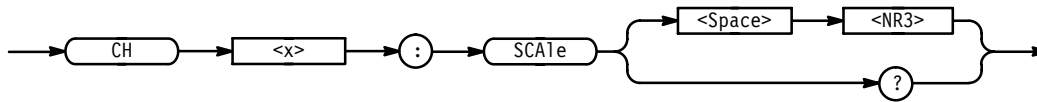

Arguments <NR3> is the gain, in volts per division. The range is 100 mV per division to 1 mV per division when using a 1x probe.

Examples CH4:SCALE 100E-03
sets the channel 4 gain to 100 mV per division.

CH2:SCALE?
might return 1.00E+0, indicating that the current V per division setting of channel 2 is 1 V per division.

CH<x>:VOLts

Sets or queries the vertical gain of the specified channel. This command is identical to the CH<x>:SCALE command and is included for compatibility purposes. Only CH<x>:SCALE is returned in response to a CH<x>? query.

Group Vertical

Related Commands CH1:SCALE

Syntax CH<x>:VOLts <NR3>

CH<x>:VOLts?

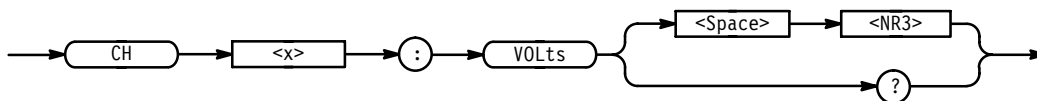

Examples CH4:VOLTS 100E-03
sets the channel 4 gain to 100 mV per division.

CH2:VOLTS?
might return 1.00E+0, indicating that the current V per division setting of channel 2 is 1 V per division.

CLEARMenu (No Query Form)

Clears the current menu from the display. This command is equivalent to pressing the **CLEAR MENU** button on the front panel.

Group Display

Syntax CLEARMenu

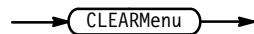

Examples CLEARMENU
clears the menu from the display.

*CLS (No Query Form)

Clears the digitizing oscilloscope status data structures.

Group Status and Error

Related Commands DESE, *ESE, *ESR?, EVENT?, EVMsg?, *SRE, *STB?

Syntax *CLS

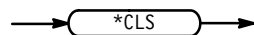

The *CLS command clears the following:

- the Event Queue
- the Standard Event Status Register (SESR)
- the Status Byte Register (except the MAV bit; see below)

If the *CLS command immediately follows an <E0I>, the Output Queue and MAV bit (Status Byte Register bit 4) are also cleared. MAV indicates information is in the output queue. The device clear (DCL) GPIB control message will clear the output queue and thus MAV. *CLS does not clear the output queue or MAV. (A complete discussion of these registers and bits, and of event handling in general, begins on page 3-1.)

*CLS can suppress a Service Request that is to be generated by an *OPC. This will happen if a hardcopy output or single sequence acquisition operation is still being processed when the *CLS command is executed.

CURSor? (Query Only)

Returns all current cursor settings.

Group Cursor

Syntax CURSor?

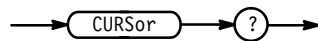

Examples CURSOR?
 might return :CURSOR:FUNCTION OFF;VBARS:UNITS SECONDS;
 POSITION1 500.0E-6;POSITION2 4.50E-3;SELECT CURSOR1;
 :CURSOR:HBARS:POSITION1 3.20E+0;POSITION2 -3.20E+0;
 SELECT CURSOR1 as the current cursor settings.

CURSor:FUNction

Selects and displays the cursor type. Cursors are attached to the selected waveform. This command is equivalent to setting **Function** in the Cursor menu.

Group Cursor

Related Commands SElect:CONTROl

Syntax CURSor:FUNction { HBArS | OFF | VBArS | PAIred }
 CURSor:FUNction?

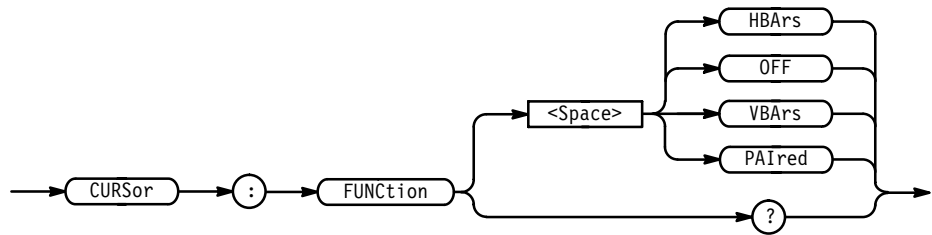

Arguments HBArS specifies horizontal bar cursors that measure volts.
 OFF removes the cursors from the display.
 VBArS specifies vertical bar cursors that measure time.
 PAIred specifies paired cursors that measure both time and volts.

Examples CURSOR:FUNction VBARS
 selects vertical bar type cursors.

CURSor:HBArS? (Query Only)

Returns the current settings for the horizontal bar cursors.

Group Cursor

Syntax CURSor:HBArS?

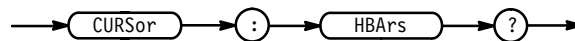

Examples CURSOR:HBARS?
 might return :CURSOR:HBARS:POSITION1 0;POSITION2 0;SELECT CURSOR1.

CURSor:HBArS:DELTA? (Query Only)

Returns the voltage difference between the two horizontal bar cursors.

Group Cursor

Syntax CURSor:HBArS:DELTA?

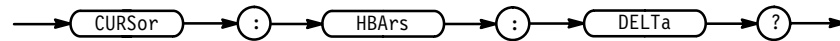

Returns <NR3>

Examples CURSOR:HBARS:DELTA?
might return 5.08E+0 for the voltage difference between the two cursors.

CURSOR:HBARS:POSITION<x>

Positions a horizontal bar cursor.

Group Cursor

Syntax CURSOR:HBARS:POSITION<x> <NR3>
CURSOR:HBARS:POSITION<x>?

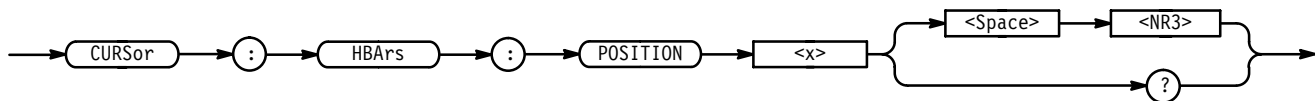

Arguments <NR3> specifies the cursor position relative to ground, in volts.

Examples CURSOR:HBARS:POSITION1 25.0E-3
positions one of the horizontal cursors at 25.0 mV.
CURSOR:HBARS:POSITION2?
might return -64.0E-3, indicating that one of the horizontal bar cursors is at -64.0 mV.

CURSOR:HBARS:POSITION<x>Pcnt

TDS 4XXA Only

Sets or queries the position of the horizontal bar cursors (x is either 1 or 2) in units of % of vertical range.

Group Cursor

Syntax CURSOR:HBARS:POSITION<x>Pcnt <NR3>

CURSor:HBArS:POSITION<x>Pcnt?

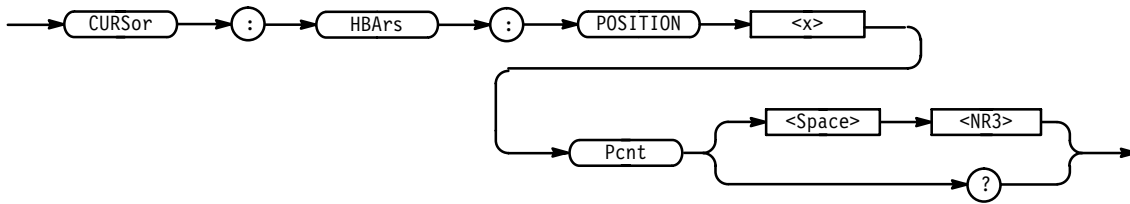

Arguments <NR3> has a range of 0 to 100 (%). It specifies the cursor position relative to the vertical range of the selected waveform.

Examples CURSOR:HBARS:POSITION1PCNT?
might return 4.50 E+1, indicating cursor 1 is positioned at 45% of the vertical range of the selected waveform.

CURSor:HBArS:SELEct

Selects which horizontal bar cursor is active for front-panel control. The active cursor will be displayed as a solid horizontal line and can be moved using the front-panel general purpose knob when the cursor menu is active. The unselected cursor will be displayed as a dashed horizontal line. This command is equivalent to pressing the **SELECT** button on the front panel when the Cursor menu is displayed.

Group Cursor

Syntax CURSor:HBArS:SELEct { CURSOR1 | CURSOR2 }
CURSor:HBArS:SELEct?

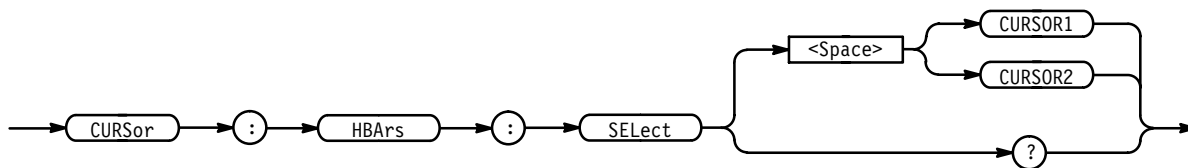

Arguments CURSOR1 selects the first horizontal bar cursor.
CURSOR2 selects the second horizontal bar cursor.

- Examples** `CURSOR:HBARs:SELECT CURSOR1`
selects the first horizontal bar cursor as the active cursor.
- `CURSOR:HBARs:SELECT?`
returns CURSOR1 when the first cursor is the active cursor.

CURSOR:HBARs:UNITs

TDS 4XXA, 5XXA, 6XXA, & 7XXA Only

Sets or queries the units for the horizontal bar cursors. This command is equivalent to setting **Amplitude** in the Cursor menu.

- Group** Cursor
- Syntax** `CURSOR:HBARs:UNITs { BASe | IRE }`
`CURSOR:HBARs:UNITs?`

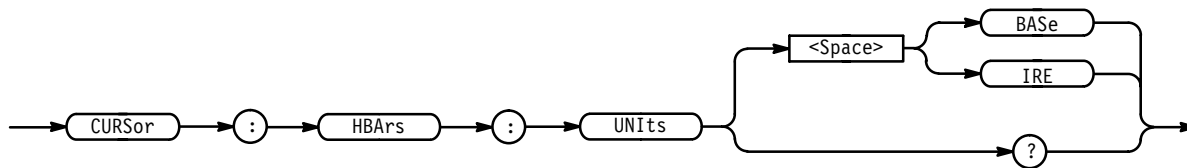

- Arguments** BASe specifies base as the unit of measure.
- IRE specifies IRE as the unit of measure. These units are typically used with video signals.

- Examples** `CURSOR:HBARs:UNITs BASe`
sets the units for the horizontal bar cursors to base.
- `CURSOR:HBARs:UNITs?`
returns IRE when the horizontal bar cursor units are IRE.

CURSOR:MODE

Selects whether the two cursors move together in unison or separately.

- Group** Cursor

Related Commands CURSor:FUNcTion

Syntax CURSor:MODe { TRACk | INDepeNdeNt }
 CURSor:MODe?

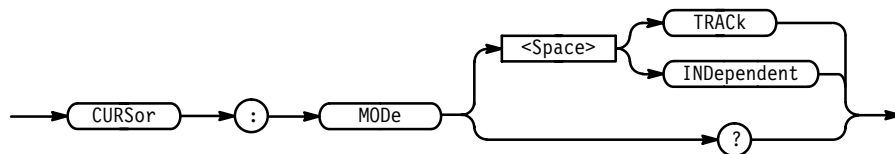

Arguments TRACk ties the two cursors together as you move the general purpose knob.
 INDepeNdeNt frees the two cursors to move separately.

Examples CURSOR:MODE TRACK
 specifies that the cursors positions move in unison.
 CURSOR:MODE?
 might return :TRACK showing the two cursors move in unison.

CURSor:PAIred

Positions the paired cursors. Also, returns the current paired cursor settings.

Group Cursor

Related Commands DATA:STARt, DATA:STOP

Syntax CURSor:PAIred SNAp
 CURSor:PAIred?

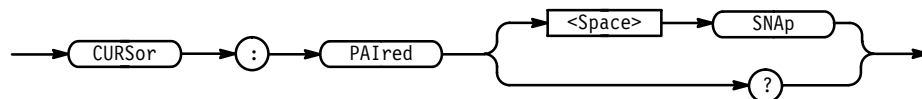

Arguments SNAp positions the paired cursors at DATA:STARt and DATA:STOP.

Examples `CURSOR:PAIRED SNAP`
 specifies the positions of the cursors are at the current `DATA:START` and `DATA:STOP` values.

`CURSOR:PAIRED?`
 might return `:CURSOR:PAIRED:UNITS BASE;POSITION1 -2.00E-3;POSITION2 2.00E-3;SELECT CURSOR2.`

CURSOR:PAIRED:HDELTA (Query Only)

Queries the hbar (voltage) distance between the first and second paired cursor. This is the absolute value of the vertical position of the first cursor minus the vertical position of the second cursor.

Group Cursor

Related Commands `CURSOR:FUNCTION`

Syntax `CURSOR:PAIRED:HDELTA?`

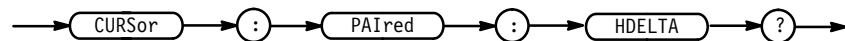

Examples `CURSOR:PAIRED:HDELTA?`
 might return `5.08E+0` for the voltage difference between the two cursors.

CURSOR:PAIRED:HPOS1 (Query Only)

Queries the horizontal bar (voltage) position of the first paired cursor.

Group Cursor

Related Commands `CURSOR:FUNCTION`

Syntax `CURSOR:PAIRED:HPOS1?`

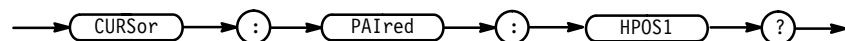

Examples `CURSOR:PAIRED:HPOS1?`
 might return `-64.0E-3`, indicating that the first cursor is at `-64.0 mV`.

CURSor:PAIred:HPOS2 (Query Only)

Queries the horizontal bar (voltage) position of the second paired cursor.

Group Cursor

Related Commands CURSor:FUNcTion

Syntax CURSor:PAIred:HPOS2?

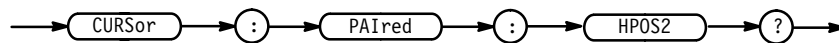

Examples CURSOR:PAIRED:HPOS2?
 might return $-64.0E-3$, indicating the second cursor is at -64.0 mV.

CURSor:PAIred:POSITION<x>

Sets or queries the vertical bar (time) position of the first or second paired cursor. x is either 1 or 2 and refers to the first or second cursor.

The CURSor:VBArS:UNits command specifies the units for these cursors.

Group Cursor

Related Commands CURSor:FUNcTion, CURSor:VBArS:UNits

Syntax CURSor:PAIred:POSITION2 <NR3>

CURSor:PAIred:POSITION2?

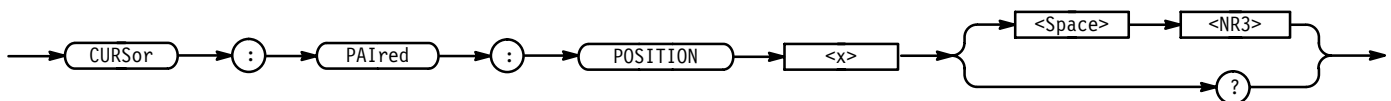

Arguments <NR3> specifies the cursor position in the units specified by the CURSor:VBArS:UNits command.

The position can appear in units of seconds, 1/seconds (hertz), or video line numbers (with option 05). On the TDS 4XXA, position can also appear in units of clocks or 1/clocks.

- Examples** `CURSOR:PAIRED:POSITION1 9.00E-6`
 specifies the first paired cursor is at 9 μ s.
- `CURSOR:POSITION2?`
 might return 1.00E-6, indicating that the second paired cursor is at 1 μ s.

CURSOR:PAIRED:POSITION<x>Pcnt

TDS 4XXA Only

Sets or queries the horizontal position of the paired cursors (x is either 1 or 2) in units of % of record length.

- Group** Cursor
- Syntax** `CURSOR:PAIRED:POSITION<x>Pcnt <NR3>`
`CURSOR:PAIRED:POSITION<x>Pcnt?`

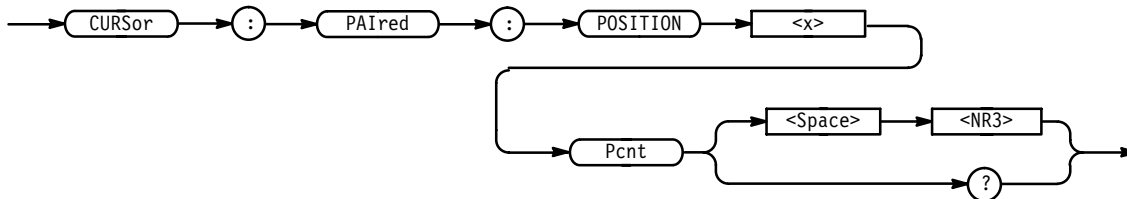

- Arguments** `<NR3>` has a range of 0 to 100 (%). It specifies the cursor position relative to the record length of the selected waveform.
- Examples** `CURSOR:PAIRED:POSITION1PCNT?`
 might return 4.50 E+1, indicating cursor 1 is positioned at 45% of the record length of the selected waveform.

CURSOR:PAIRED:SElect

Selects the active paired cursor. The active cursor appears as a solid vertical line. The unselected cursor appears as a dashed vertical line. This command is equivalent to pressing the **SELECT** button on the front panel when the Cursor menu is displayed.

- Group** Cursor

Syntax CURSor:PAIred:SElect { CURSOR1 | CURSOR2 }
 CURSor:PAIred:SElect?

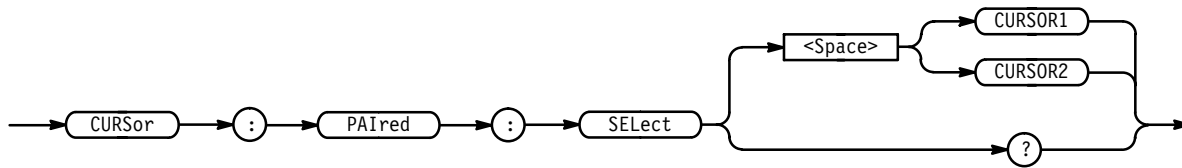

Arguments CURSOR1 specifies the first paired cursor.
 CURSOR2 specifies the second paired cursor.

Examples CURSOR:PAIRED:SELECT CURSOR2
 selects the second paired cursor as the active cursor.
 CURSOR:PAIRED:SELECT?
 returns CURSOR1 when the first paired cursor is the active cursor.

CURSor:PAIred:UNIts

Sets or queries the units for the paired cursors. This is equivalent to setting **Amplitude** in the Cursor menu.

Group Cursor

Syntax CURSor:PAIred:UNIts { BASe | IRE }
 CURSor:PAIred:UNIts?

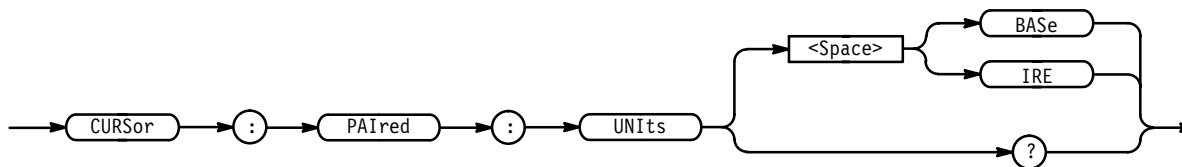

Arguments BASe specifies base as the unit of measure.
 IRE specifies IRE as the unit of measure. These units are typically used with video signals.

Examples `CURSOR:PAIRED:UNITS BASE`
sets the units for the paired cursors to base.

`CURSOR:PAIRED:UNITS?`
returns IRE when the paired cursor units are IRE.

CURSOR:PAIRED:VDELTA (Query Only)

Queries the vbar (time) distance between paired cursors. It returns the absolute value of the first cursor less the second cursor horizontal positions.

The position can appear in units of seconds, 1/seconds (hertz), or video line numbers (with option 05). On the TDS 4XXA, position can also appear in units of clocks or 1/clocks.

Group Cursor

Related Commands `CURSOR:FUNCTION`

Syntax `CURSOR:PAIRED:VDELTA?`

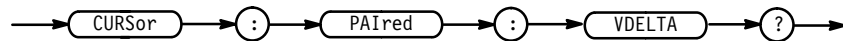

Examples `CURSOR:PAIRED:VDELTA?`
might return `1.064E+00`, indicating that the time between the paired cursors is 1.064 seconds.

CURSOR:VBARS

Positions the vertical bar cursors and the `CURSOR:VBARS?` query returns the current vertical bar cursor settings for horizontal position, delta, cursor selection, and units.

The position can appear in units of seconds, 1/seconds (hertz), or video line numbers (with option 05). On the TDS 4XXA, position can also appear in units of clocks or 1/clocks.

Group Cursor

Related Commands DATA:START, DATA:STOP, MEASUREMENT:GATING

Syntax CURSOR:VBARS SNAP
CURSOR:VBARS?

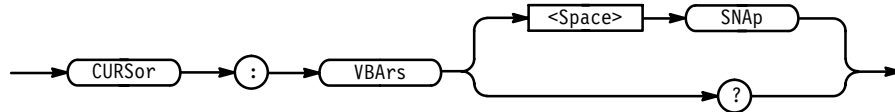

Arguments SNAP positions the vertical bar cursors at DATA:START and DATA:STOP.

Examples CURSOR:VBARS SNAP
specifies that the cursors positions are the same as the current DATA:START and DATA:STOP values.

CURSOR:VBARS?
might return :CURSOR:VBARS:UNITS SECONDS;POSITION1 1.00E-6;POSITION2 9.00E-6;SELECT CURSOR2.

CURSOR:VBARS:DELTA? (Query Only)

Returns the time or frequency between the two vertical bar cursors. The units, seconds or Hertz, are specified by the CURSOR:VBARS:UNITS command.

The position can appear in units of seconds, 1/seconds (hertz), or video line numbers (with option 05). On the TDS 4XXA, position can also appear in units of clocks or 1/clocks.

Group Cursor

Related Commands CURSOR:VBARS:UNITS

Syntax CURSOR:VBARS:DELTA?

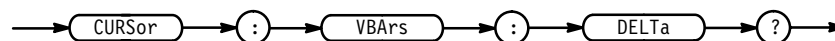

Returns <NR3>

Examples `CURSOR:VBARS:DELTA?`
might return `1.064E+00`, indicating that the time between the vertical bar cursors is 1.064 seconds.

`CURSOR:VBARS:POSITION<x>`

Positions a vertical bar cursor for both vertical bar and paired cursors. The `CURSOR:VBARS:UNITS` command specifies units.

The position can appear in units of seconds, 1/seconds (hertz), or video line numbers (with option 05). On the TDS 4XXA, position can also appear in units of clocks or 1/clocks.

Group Cursor

Related Commands `CURSOR:VBARS:UNITS`

Syntax `CURSOR:VBARS:POSITION<x> <NR3>`
`CURSOR:VBARS:POSITION<x>?`

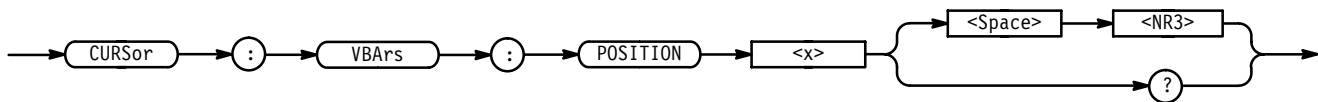

Arguments `<NR3>` specifies the cursor position in the units specified by the `CURSOR:VBARS:UNITS` command. The position is relative to the trigger position.

Examples `CURSOR:VBARS:POSITION2 9.00E-6`
positions one of the vertical bar cursors at 9 μ s.
`CURSOR:VBARS:POSITION1?`
might return `1.00E-6`, indicating a vertical bar cursors is at 1 μ s.

`CURSOR:VBARS:POSITION<x>Pcnt`

TDS 4XXA Only

Sets or queries the position of the vertical bar cursors (`x` is either 1 or 2) in units of % of record length.

Group Cursor

Syntax CURSor:VBArS:POSITION<x>Pcnt <NR3>
 CURSor:VBArS:POSITION<x>Pcnt?

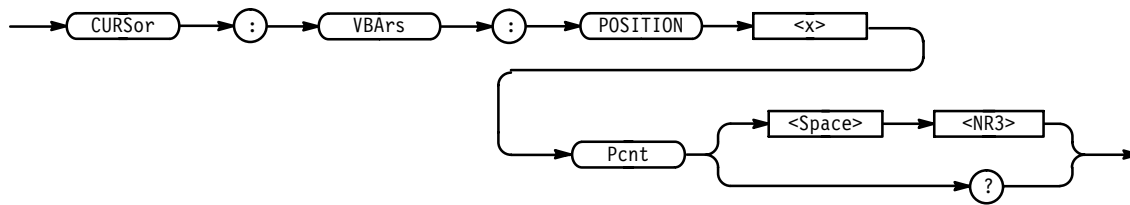

Arguments <NR3> has a range of 0 to 100 (%). It specifies the cursor position relative to the record length of the selected waveform.

Examples CURSOR:VBARS:POSITION1PCNT?
 might return 4.50 E+1, indicating cursor 1 is positioned at 45% of the record length of the selected waveform.

CURSor:VBArS:SElect

Selects which vertical bar cursor is active. The active cursor will be displayed as a solid vertical line and can be moved using the front-panel general purpose knob when the cursor menu is active. The unselected cursor will be displayed as a dashed vertical line. This command is equivalent to pressing the **SELECT** button on the front panel when the Cursor menu is displayed.

Group Cursor

Syntax CURSor:VBArS:SElect { CURSOR1 | CURSOR2 }
 CURSor:VBArS:SElect?

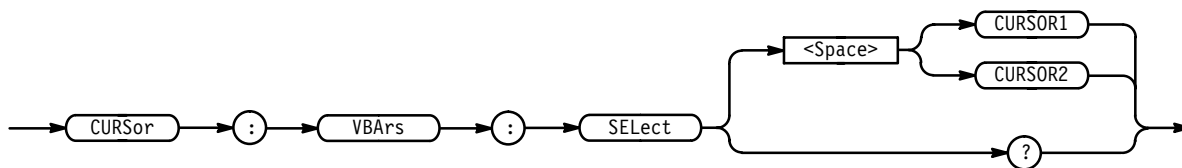

Arguments CURSOR1 specifies the first vertical bar cursor.

CURSOR2 specifies the second vertical bar cursor.

Examples `CURSOR:VBARS:SELECT CURSOR2`
 selects the second vertical bar cursor as the active cursor.

`CURSOR:VBARS:SELECT?`
 returns CURSOR1 when the first vertical bar cursor is the active cursor.

CURSOR:VBARS:UNITs

Sets or queries the units for the vertical bar cursors. This command is equivalent to setting **Time Units** (**Horiz Units** in the TDS 4XXA) in the Cursor menu.

Group Cursor

Related Commands `CURSOR:VBARS:DELTA?`, `CURSOR:VBARS:POSITION<x>`

Syntax `CURSOR:VBARS:UNITs { SECOnds | HERTz | LINE (with option 05) | BAsE (TDS 4XXA only) | INVert (TDS 4XXA only) }`

`CURSOR:VBARS:UNITs?`

For the TDS 5XXA, 6XXA, & 7XXA:

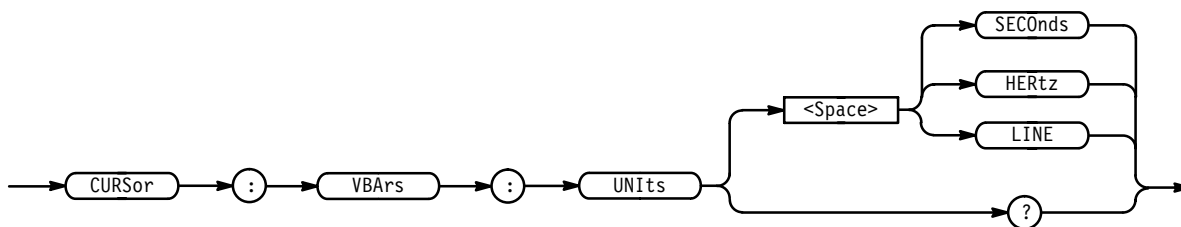

For the TDS 4XXA:

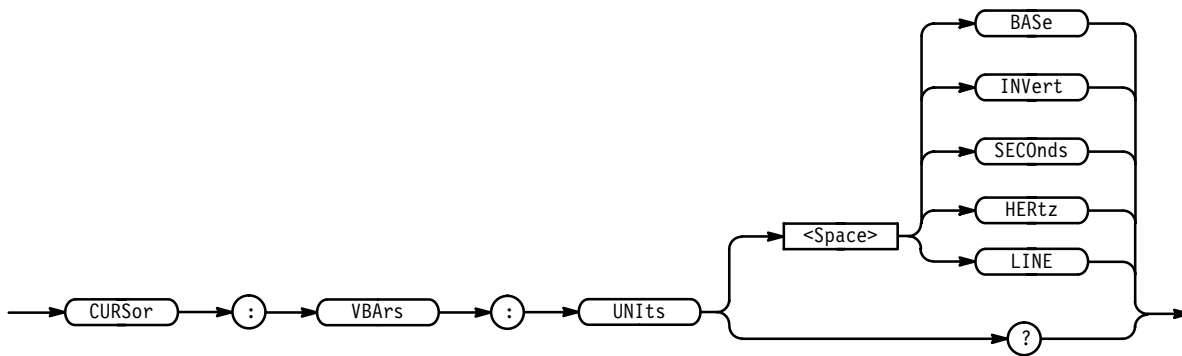

Arguments

SECOnds specifies seconds as the unit of measure. For the TDS 4XXA, this argument is available only for backward compatibility. If a TDS 4XXA receives this argument, it will convert it to BASE or INVERT depending on the selected waveform. The TDS 4XXA will not output this argument in response to a query.

HERTz specifies hertz as the unit of measure. For the TDS 4XXA, this argument is available only for backward compatibility. If a TDS 4XXA receives this argument, it will convert it to BASE or INVERT depending on the selected waveform. The TDS 4XXA will not output this argument in response to a query.

LINE specifies a video line as the unit of measure. This is most useful if you have option 05 video trigger installed. On some models, if you do not have option 05, use of this argument will generate an error message. On the TDS 4XXA, if you do not have option 05, the TDS 4XXA will use the NTSC standard for converting from time to lines. In order for the measurement to be accurate in the TDS 4XXA when TRIGGER:MAIN:VIDEO:SYSTEM is set to custom, you must set TRIGGER:MAIN:VIDEO:SCANPERIOD.

BAsE (TDS 4XXA only) specifies the base (or natural) units of the waveform as the unit of measurement. If internal clock is enabled, the base units are seconds. If external clock is enabled, the base units are clocks.

INVert (TDS 4XXA only) specifies 1/ base (or natural) units of the waveform as the unit of measurement. If internal clock is enabled, the base units are 1/seconds (hertz). If external clock is enabled, the base units are 1/clocks.

Examples

CURSOR:VBARS:UNITS SECONDS
sets the units for the vertical bar cursors to seconds.

CURSOR:VBARS:UNITS?
returns HERTZ when the vertical bar cursor units are hertz.

CURSor:VBArS:UNITSTring? (Query Only)

TDS 4XXA Only

Queries the unit string as shown on screen for the vertical bar cursor readout.

Group Cursor

Syntax CURSor:VBArS:UNITSTring?



Examples CURSOR:VBARS:UNITSTRING?
might return "ms", indicating the units are milliseconds.

CURVe

Transfers waveform data to and from the digitizing oscilloscope in binary or ASCII format. Each waveform that is transferred has an associated waveform preamble which contains information such as data format and scale. Refer to the WFMPre command starting on page 2–288 for information about the waveform preamble. The data format is specified by the DATA:ENCdg and DATA:WIDTH commands.

The CURVe? query transfers data from the instrument. The data source is specified by the DATA:SOUrce command. If more than one source is specified, a comma separated list of data blocks is returned. The first and last data points that are transferred are specified by the DATA:STARt and DATA:STOP commands.

The CURVe command transfers waveform data to the instrument. The data is stored in the reference memory location specified by DATA:DESTination starting with the data point specified by DATA:STARt. Only one waveform can be transferred at a time. The waveform will only be displayed if the reference is displayed.

A description of the waveform transfer process starts on page 2–32.

Group Waveform

Related Commands DATA, WFMPre

Syntax CURVe { <Block> | <asc curve> }

CURVe?

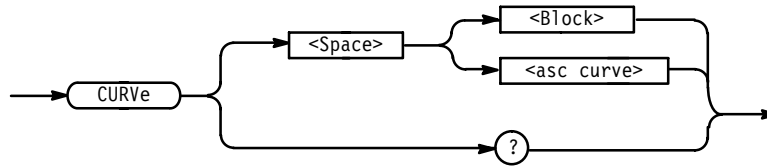

Arguments

<Block> is the waveform data in binary format. The waveform is formatted as: #<x><yyy><data><newline> where <x> is the number of y bytes. For example, if <yyy> = 500, then <x> = 3. <yyy> is the number of bytes to transfer. If width is 1 then all bytes on the bus are single data points. If width is 2 then all bytes on the bus are 2-byte pairs. Use the DATA:WIDTH command to set the width. <data> is the curve data. <newline> is a single byte newline character at the end of the data. See the GETWFM.C or GETWFM.BAS examples in the accompanying disk for more specifics.

<asc curve> is the waveform data in ASCII format. The format for ASCII data is <NR1>[, <NR1>...] where each <NR1> represents a data point.

Examples

CURVE?
 might return, for ASCII data: CURVE
 0,0,0,0,-1,1,0,-1,0,0,-1,0,0,-1,0,-1,
 -1,1,0,0,0,-1,0,0,-1,0,1,1,0,-1,0,0,-1,0,0,-1,0,0

DATA

Sets or queries the format and location of the waveform data that is transferred with the CURVE command. Since DATA:DESTINATION and DATA:TARGET are equivalent, only DATA:DESTINATION is returned by the DATA? query.

Group Waveform

Related Commands CURVE, WAVFrm

Syntax DATA { INIT | SNAP }
DATA?

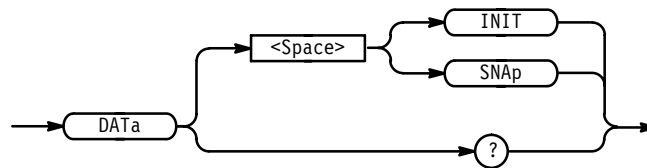

Arguments INIT initializes the waveform data parameters to their factory defaults.

SNAP sets DATA:START and DATA:STOP to match the current vertical bar cursor positions.

Examples DATA SNAP
assigns the current position of the vertical bar cursors to DATA:START and DATA:STOP.

DATA?
might return the string :DATA:ENCDG RPBINARY;DESTINATION REF4; SOURCE REF4;START 1;STOP 500;WIDTH 2

DATA:DESTINATION

Sets or queries the reference memory location for storing waveform data that is transferred into the digitizing oscilloscope by the CURVE command. This command is identical to the DATA:TARGET command.

Group Waveform

Syntax DATA:DESTINATION REF<x>

DATA:DESTINATION?

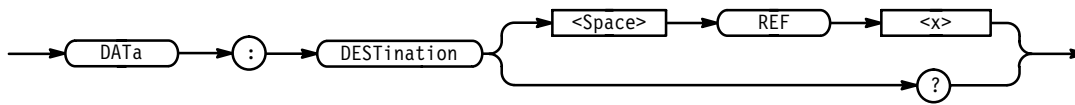

Arguments REF<x> (REF1, REF2, REF3 or REF4) is the reference memory location where the waveform will be stored.

Examples DATA:DESTINATION REF3
stores incoming waveform data in reference memory 3.

DATA:DESTINATION?
might return REF2 as the reference memory location that is currently selected.

DATA:ENCdg

Sets or queries the format of the waveform data. This command is equivalent to setting WFMPre:ENCdg, WFMPre:BN_Fmt, and WFMPre:BYT_Or as shown in Table 2–27. Setting the DATA:ENCdg value causes the corresponding WFMPre values to be updated and vice versa.

Group Waveform

Related Commands WFMPre:ENCdg, WFMPre:BN.FMT, WFMPre:BYT_Or

Syntax DATA:ENCdg { ASCIi | RIBinary | RPBinary | SRIBinary | SRPbinary }

DATA:ENCdg?

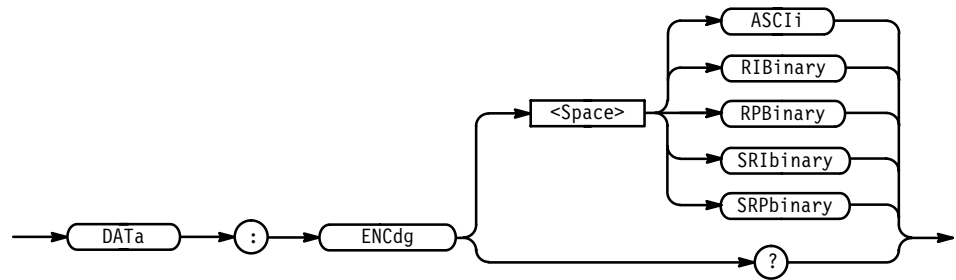

Arguments `ASCIi` specifies the ASCII representation of signed integer (RIBinary) data. If this is the value at power-on, the `WFMPre` values for `BN_Fmt`, `BYT_Or`, and `ENCdg` are set as `RP`, `MSB`, and `ASC` respectively.

`RIBinary` specifies signed integer data-point representation with the most significant byte transferred first. This format results in the fastest data transfer rate when `DATA:WIDTH` is set to 2.

The range is -128 to 127 when `DATA:WIDTH` is 1. Zero is center screen. The range is -32768 to 32767 when `DATA:WIDTH` is 2. The upper limit is one division above the top of the screen and the lower limit is one division below the bottom of the screen.

`RPBinary` specifies positive integer data-point representation with the most significant byte transferred first.

The range is 0 to 255 when `DATA:WIDTH` is 1. 127 is center screen. The range is 0 to 65,535 when `DATA:WIDTH` is 2. The upper limit is one division above the top of the screen and the lower limit is one division below the bottom of the screen.

`SRIBinary` is the same as `RIBinary` except that the byte order is swapped, meaning that the least significant byte is transferred first. This format is useful when transferring data to IBM compatible PCs.

`SRPBinary` is the same as `RPBinary` except that the byte order is swapped, meaning that the least significant byte is transferred first. This format is useful when transferring data to IBM compatible PCs.

Table 2–27: DATA and WFMPre Parameter Settings

DATA:ENCdg Setting	WFMPre Settings		
	:ENCdg	:BN_Fmt	:BYT_Or
ASCIi	ASC	N/A	N/A
RIBinary	BIN	RI	MSB
RPBinary	BIN	RP	MSB
SRIBinary	BIN	RI	LSB
SRIBinary	BIN	RP	LSB

Examples DATA:ENCDG RPBINARY
 sets the data encoding format to be positive integer where the most significant byte is transferred first.

DATA:ENCDG?
 might return SRPBINARY for the format of the waveform data.

DATA:SOURce

Sets or queries the location of the waveform data that is transferred from the instrument by the CURVe? query. The source data is always transferred in a predefined order regardless of the order they are specified using this command. The predefined order is CH1 through CH4, MATH1 through MATH3, then REF1 through REF4.

Group Waveform

Syntax DATA:SOURce <wfm> [<Comma><wfm>] ...

DATA:SOURce?

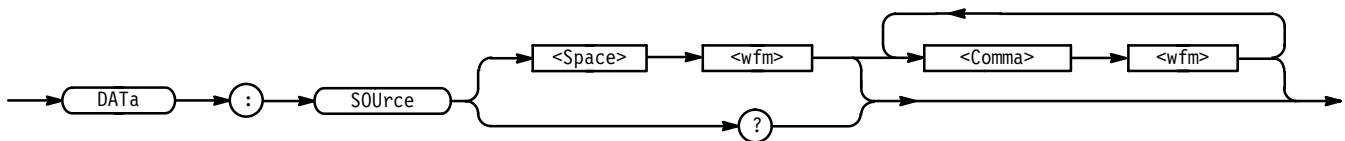

Arguments <wfm> is the location of the waveform data that will be transferred from the digitizing oscilloscope to the controller.

- Examples** DATA:SOURCE REF2, CH2, MATH1, CH1 specifies that four waveforms will be transferred in the next CURVE? query. The order that the data will be transferred is CH1, CH2, MATH1, and then REF2.
- DATA:SOURCE? might return REF3, indicating the source for the waveform data that is transferred using a CURVE? query.

DATA:START

Sets or queries the starting data point for waveform transfer. This command allows for the transfer of partial waveforms to and from the digitizing oscilloscope.

Group Waveform

Related Commands CURVe?, DATA:SNAP, DATA:STOP

Syntax DATA:START <NR1>
DATA:START?

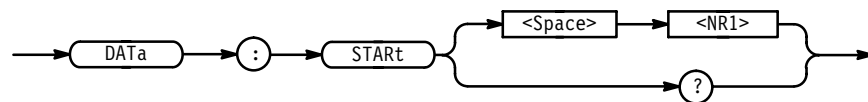

Arguments <NR1> ranges from 1 to the record length, and is the first data point that will be transferred. Data will be transferred from <NR1> to DATA:STOP or the record length, whichever is less. If <NR1> is greater than the record length then no data will be transferred.

When DATA:STOP is less than DATA:START, the stop value will equal DATA:START + (DATA:START – DATA:STOP). For example, if DATA:START = 30 and DATA:STOP = 20, then the range of data points for the waveform transfer will equal 30 through 40.

- Examples** DATA:START 10 specifies that the waveform transfer will begin with data point 10.
- DATA:START? might return 214 as the first waveform data point that will be transferred.

DATA:STOP

Sets or queries the last data point that will be transferred when using the CURVe? query. This allows the transfer of partial waveforms to the controller.

When using the CURVe command, the digitizing oscilloscope will stop reading data when there is no more data to read or when the specified record length has been reached so this command will be ignored.

Group Waveform

Related Commands CURVe?, DATA SNAp

Syntax DATA:STOP <NR1>
DATA:STOP?

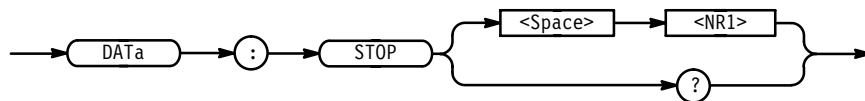

Arguments <NR1> ranges from 1 to the record length, and is the last data point that will be transferred. If <NR1> is greater than the record length then data will be transferred up to the record length. If both DATA:START and DATA:STOP are greater than the record length, an execution error will be executed.

If you always want to transfer complete waveforms, just set DATA:START to 1 and DATA:STOP to the maximum record length.

When DATA:STOP is less than DATA:START, the stop value will equal DATA:START + (DATA:START – DATA:STOP). For example, if DATA:START = 30 and DATA:STOP = 20, then the range of data points for the waveform transfer will equal 30 through 40.

Examples DATA:STOP 15000
specifies that the waveform transfer will stop at data point 15000.

DATA:STOP?
might return 14900 as the last data point that will be transferred.

DATA:TARget

Sets or queries the location for storing waveform data transferred to the instrument using the CURVe command. This command is equivalent to the

DATA:DESTINATION command and is included for compatibility with older Tektronix instruments.

Group Waveform

Related Commands CURVe

Syntax DATA:TARget REF<x>
DATA:TARget?

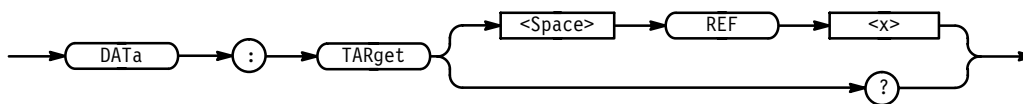

DATA:WIDTH

Sets the number of bytes per data point in the waveform transferred using the CURVe command.

Group Waveform

Related Commands CURVe, WFMPre:BIT_Nr, WFMPre:BYT_Nr

Syntax DATA:WIDTH <NR1>
DATA:WIDTH?

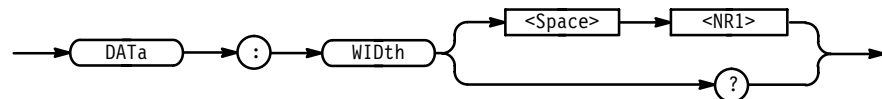

Arguments <NR1> = 1 specifies that there is 1 byte (8 bits) per point. This format is useful when the acquisition mode is set to SAMple, ENvelope, or PEAKdetect (one byte per point). If used for AVERage or HIRes (two bytes per point), the low order byte is not transmitted.

<NR1> = 2 specifies that there are 2 bytes (16 bits) per point. This format is useful for AVERage and HIRes (two bytes per point) waveforms. If used for ENvelope, PEAKdetect, or SAMple (one byte per point), the least significant byte is always zero.

Examples DATA:WIDth 1
 sets the data width to 1 byte per data point for CURVe data.

DATE

Sets or queries the date that the digitizing oscilloscope can display.

Group Miscellaneous

Related Commands DISPlay: CLOCk, TIME

Syntax DATE <QString>
 DATE?

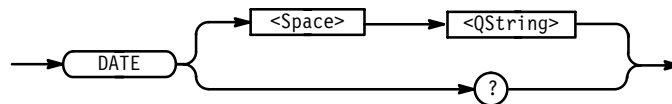

Arguments <QString> is a date in the form "yyyy-mm-dd".
 mm refers to a two-digit month number from 01 to 12.
 dd refers to a two-digit day number in the month.
 yyyy refers to a four-digit year number.
 There must a dash (–) after the yyyy and after the mm.

Examples DATE "1993-01-24"
 specifies that the date is set to January 24th, 1993.

*DDT

Allows the user to specify a command or a list of commands that are executed when the instrument receives a *TRG command or the GET GPIB interface message. This is just a special alias that *TRG uses.

Group Miscellaneous

Related Commands ALIAS:DEFINE, *TRG, Get GPIB interface message

Syntax *DDT { <Block> | <QString> }

*DDT?

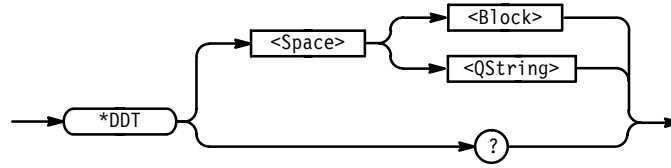

Arguments <Block> or <QString> is a complete sequence of program messages. The messages can contain only valid commands that must be separated by semicolons and must follow all rules for concatenating commands (see page 2–4). The sequence must be ≤80 characters. <Block> format is always returned as a query response.

Examples *DDT #0ACQUIRE:STATE RUN;BELL<EOI>
 specifies that the acquisition system will be started and the bell rings each time a *TRG command is sent.

DELEte:SETUp (No Query Form)

Removes stored setups from memory and initializes the location with the factory default setup.

NOTE. The setup information cannot be recovered once it has been deleted.

Group Save and Recall

Related Commands *RCL, RECAI:SETUp, *RST, *SAV, SAVe:SETUp, TEKSecure

Syntax DELEte:SETUp { <NR1> | ALL }

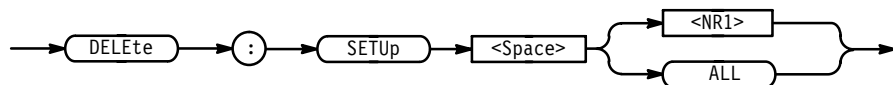

Arguments <NR1> is a value in the range 1 to 10, and specifies a setup storage location. Using an out-of-range value causes an execution error.

ALL specifies all the stored setups.

Examples `DELETE:SETUP ALL`
 removes all stored setups. All ten storage locations are initialized to the factory default setup.

DELEte:WAVEform (No Query Form)

Deletes one or all of the stored reference waveforms from memory. The memory allocated for the reference location is then available for reallocation. Memory must be reallocated for the deleted references before any waveform data can be stored in the reference location.

NOTE. *The waveform data is not actually cleared from the reference location.*

Group Save and Recall

Related Commands `RECALL:WAVEform`, `SAVE:WAVEform`, `TEKSecure`

Syntax `DELEte:WAVEform { REF<x> | ALL }`

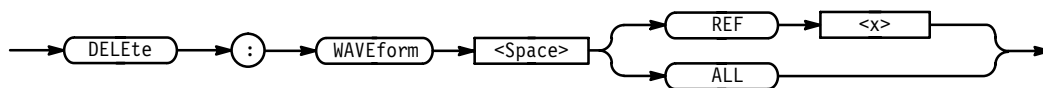

Arguments `REF<x>` (REF1, REF2, REF3 or REF4) specifies one of the reference memory locations.

`ALL` specifies all the stored waveforms.

Examples `DELETE:WAVEFORM ALL`
 removes all the waveforms stored in reference memory.

`DELETE:WAVEFORM REF2`
 removes the waveform stored at REF2.

DESE

Sets and queries the bits in the Device Event Status Enable Register (DESER). The DESER is the mask that determines whether events are reported to the Standard Event Status Register (SESR), and entered into the Event Queue. For a more detailed discussion of the use of these registers, see page 3–1.

Group Status and Error

Related Commands *CLS, *ESE, *ESR?, EVENT?, EVMsg?, *SRE, *STB?

Syntax DESE <NR1>

DESE?

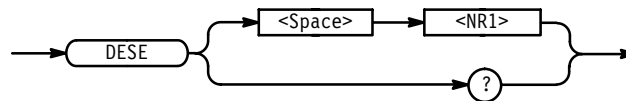

Arguments <NR1> is a value in the range from 0 to 255. The binary bits of the DESER are set according to this value. For example, DESE 209 sets the DESER to the binary value 11010001 (that is, the most significant bit in the register is set to 1, the next most significant bit to 1, the next bit to 0, etc.).

The power-on default for DESER is all bits set if *PSC is 1. If *PSC is 0, the DESER maintains its value through a power cycle.

NOTE. Setting the DESER and the ESER to the same value allows only those codes to be entered into the Event Queue and summarized on the ESB bit (bit 5) of the Status Byte Register. Use the *ESE command to set the ESER. A discussion of event handling begins on page 3–1.

Examples DESE 209
sets the DESER to binary 11010001, which enables the PON, URQ, EXE, and OPC bits.

DESE?
might return the string :DESE 186, showing that the DESER contains the binary value 10111010.

DIAG:RESULT:FLAG? (Query Only)

Returns the pass/fail status from the last diagnostic test sequence execution. The DIAG:RESULT:LOG? query can be used to determine which test(s) has failed.

Group Calibration and Diagnostic

Related Commands `DIAG:RESULT:LOG?`

Syntax `DIAG:RESULT:FLAG?`

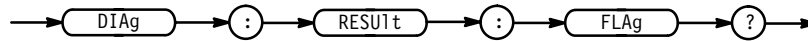

Returns `PASS` indicating that all of the selected diagnostic tests have passed.
 `FAIL` indicating that at least one of the selected diagnostic tests has failed.

Examples `DIAG:RESULT:FLAG?`
 returns either `PASS` or `FAIL`.

DIAG:RESULT:LOG? (Query Only)

Returns the internal results log from the last diagnostic test sequence execution. The list contains all modules and module interfaces that were tested along with the pass/fail status of each.

Group Calibration and Diagnostic

Related Commands `DIAG:RESULT:FLAG?`

Syntax `DIAG:RESULT:LOG?`

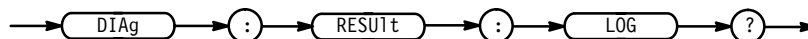

Returns `<QString>` in the following format:
 `<Status>,<Module name>[,<Status>,<Module name>...]`

Examples `DIAG:RESULT:LOG?`
 might return `:DIAG:RESULT:LOG "pass--Processor,pass--Display,pass--FP/Proc Interface,FAIL--Front Panel"`

DIAG:SElect:ACQUISition (No Query Form)

Selects the acquisition system test sequence that will be run when the DIAG:STATE EXECUte command is sent. This command is equivalent to setting **Area** in the Utility menu when **System** is set to Diag/Err.

Group Calibration and Diagnostic

Syntax DIAG:SElect:ACQUISition ALL

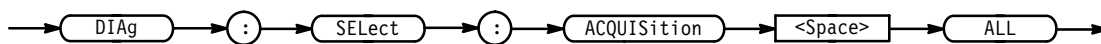

Arguments ALL selects functional, memory, and register tests.

DIAG:SElect:ALL (No Query Form)

Specifies that all system test sequences will be run when the DIAG:STATE EXECUte command is sent. This command is equivalent to setting **Area** in the Utility menu when **System** is set to Diag/Err.

Group Calibration and Diagnostic

Syntax DIAG:SElect:ALL ALL

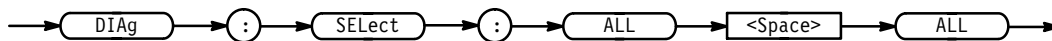

Arguments ALL selects functional, memory, and register tests for the acquisition, processor and display systems, and self diagnostics for the front panel.

DIAG:SElect:CPU (No Query Form)

Selects the processor system test sequence that will be run when the DIAG:STATE EXECUte command is sent. This command is equivalent to setting **Area** in the Utility menu when **System** is set to Diag/Err.

Group Calibration and Diagnostic

Syntax DIAG:SElect:CPU ALL

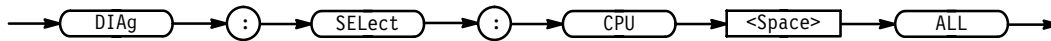

Arguments ALL selects functional, memory, and register tests.

DIAg:SElect:DISplay (No Query Form)

Selects the display system test sequence that will be run when the DIAg:STATE EXECUte command is sent. This command is equivalent to setting **Area** in the Utility menu when **System** is set to Diag/Err.

Group Calibration and Diagnostic

Syntax DIAg:SElect:DISplay ALL

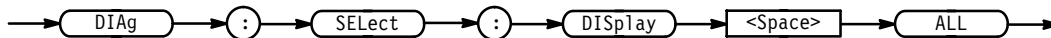

Arguments ALL selects functional, memory, and register tests.

DIAg:SElect:FPAnel (No Query Form)

Selects the front-panel test sequence that will be run when the DIAg:STATE EXECUte command is sent. This command is equivalent to setting **Area** in the Utility menu when **System** is set to Diag/Err.

Group Calibration and Diagnostic

Syntax DIAg:SElect:FPAnel ALL

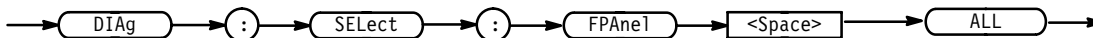

Arguments ALL selects self diagnostic tests.

DIAG:STATE (No Query Form)

Executes the diagnostic tests that have been specified with the DIAG:SELEct commands.

When the test sequence has completed, any of the modules or module interfaces that failed diagnostics are displayed on the screen and stored in an internal log file. The pass/fail status will be returned by the DIAG:RESUlt:FLAg? query, and the internal log will be returned by the DIAG:RESUlt:LOG? query. This command is equivalent to running Extended Diagnostics by selecting **Execute** in the Utility menu when **System** is set to Diag/Err.

NOTE. The DIAG:STATE EXECute command can take 30 seconds or more to respond. This command performs a warm boot and does not return control to the instrument controller until diagnostics are complete.

Group Calibration and Diagnostic

Syntax DIAG:STATE EXECute



Arguments EXECute runs the diagnostic test sequences specified by the DIAG:SELEct commands. When complete, the digitizing oscilloscope will return to the state it was in just prior to the test. If the PON event was enabled before running the tests, a Service Request will be generated. When the Service Request has been received, the pass/fail status of the tests can be returned by executing the DIAG:RESUlt:FLAg? query.

The DIAG:STATE EXECute command clears the following:

- the Event Queue
- the Input Queue
- the Status Registers (SESR and SBR)

To enable a power-on event to generate a Service Request, send the following commands before running diagnostics:

- DESE 128
- *ESE 128
- *SRE 32

- *PSC 0

Examples `DIAG:STATE EXECUTE`
 executes all the diagnostic tests that have been selected.

DISplay? (Query Only)

Returns the current display settings.

Group Display

Syntax `DISplay?`

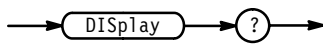

Examples `DISPLAY?`
 might return `:DISPLAY:FORMAT YT;STYLE VECTORS;FILTER SINX;PERSIST-
 ENCE 500.0E-3;GRATICULE FULL;TRIGT 1;INTENSITY:OVERALL 85;
 WAVEFORM 70;TEXT 60;CONTRAST 150`

DISplay:CLOCK

Controls the display of the date and time. This is equivalent to setting the **Display Date/Time** in the Readout Options side menu. The query form returns an ON (1) or an OFF (0).

Group Display

Syntax `DISplay:CLOCK { OFF | ON | <NR1> }`
`DISplay:CLOCK?`

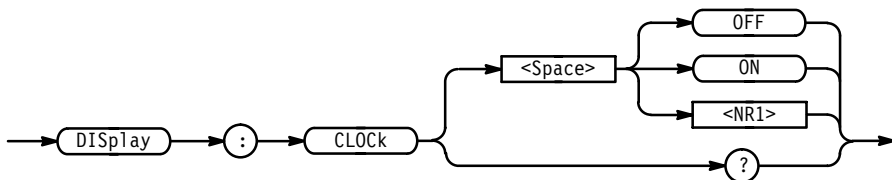

Arguments <OFF> or <NR1> = 0 removes the clock from the display.
 <ON> or <NR1> \neq 0 displays the clock on the display.

Examples DISPLAY:CLOCK ON
 sets the display to show time and date.
 DISPLAY:CLOCK?
 might return 1 indicating that the display shows time and date.

DISplay:COLOr:CONTRast

TDS 5X4A, 6X4A, & 7XXA Only

Turns on or off the collision contrast option. The TDS will display overlapping lines in a special collision color when this item is turned on. This is equivalent to selecting **Options** from the main Color menu and toggling **Collision Contrast** in the resulting side menu to **ON** or **OFF**.

Group Display

Syntax DISplay:COLOr:CONTRast { OFF | ON | <NR1> }
 DISplay:COLOr:CONTRast?

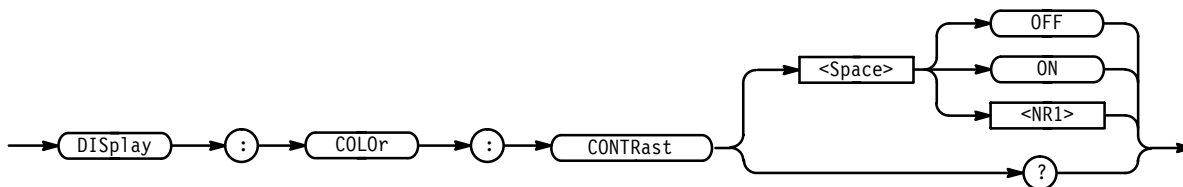

Arguments <OFF> or <NR1> = 0 turns off collision contrast.
 <ON> or <NR1> \neq 0 turns on collision contrast.

Examples DISPLAY:COLOR:CONTRAST ON
 turns on the contrast option.

DISplay:COLOr:MAP:<item name>: BYCONTents

TDS 5X4A, 6X4A, & 7XXA Only

Determines if the color for a math or reference waveform is set to the color assigned to the waveform contents (the constituent waveform) or to a specific color index. This is equivalent to pressing **Map Math Colors** or **Map Reference Colors** on the Color main menu and **Color Matches Contents** (to select the on state) or **Color** (to select the off state) on the resulting side menu.

Group Display

Syntax DISplay:COLOr:MAP:{ MATH1 | MATH2 | MATH3 | REF1 | REF2 | REF3 | REF4 }:BYCONTents { OFF | ON | <NR1> }

DISplay:COLOr:MAP:{ MATH1 | MATH2 | MATH3 | REF1 | REF2 | REF3 | REF4 }:BYCONTents?

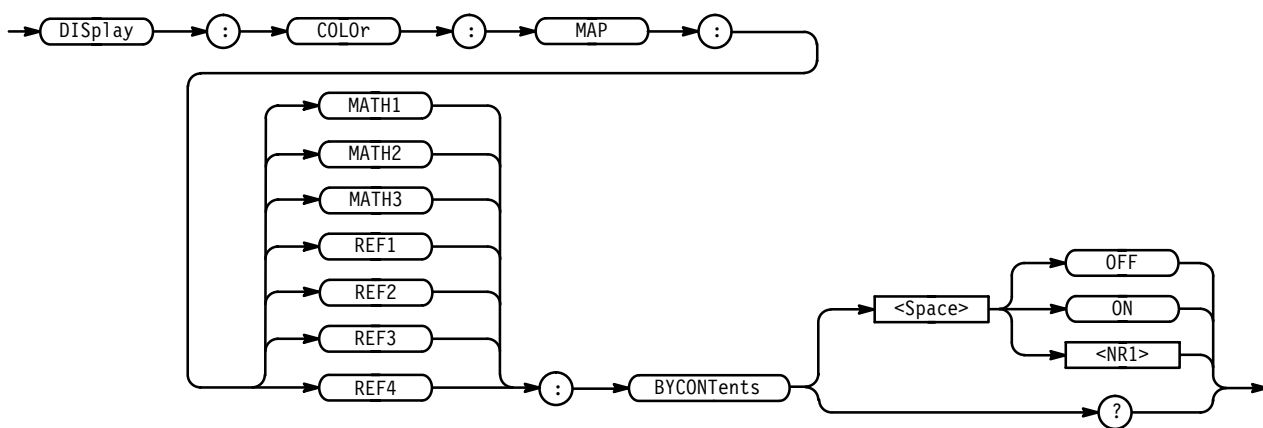

Arguments <OFF> or <NR1> = 0 means set the color by index (NOT by contents).
 <ON> or <NR1> ≠ 0 means set the color by contents (NOT by index).

Examples DISPLAY:COLOR:MAP:MATH1:BYCONTENTS ON
 sets the display of math waveform # 1 to the color of the waveform used to define math waveform # 1. If two waveforms were used to defined math waveform # 1, then the color of the first mentioned waveform is used.

DISPLAY:COLOR:MAP:MATH1:BYCONTENTS?
 might return ON.

DISplay:COLOr:MAP:<item name>: TO

TDS 5X4A, 6X4A, & 7XXA Only

Defines the color index to use if setting the color for a math or reference waveform to the color assigned to a specific index. This is similar, but not identical, to pressing **Map Math Colors** or **Map Reference Colors** on the Color main menu, pressing **Color** on the resulting side menu, and entering an index with the general purpose knob or the keypad. The difference is that, when you press **Color** on the front panel, you not only select a color index but also state that you wish to select by index rather than by contents. In contrast, when you use this command you only select the index to use. To state you want to select by index, use the DISplay:COLOr:MAP: . . . :BYCONTentS command with the OFF argument.

Group Display

Syntax DISplay:COLOr:MAP:{ MATH1 | MATH2 | MATH3 | REF1 | REF2 | REF3 | REF4 } : TO { CH1 | CH2 | CH3 | CH4 | MATH | REF }

DISplay:COLOr:MAP:TO?

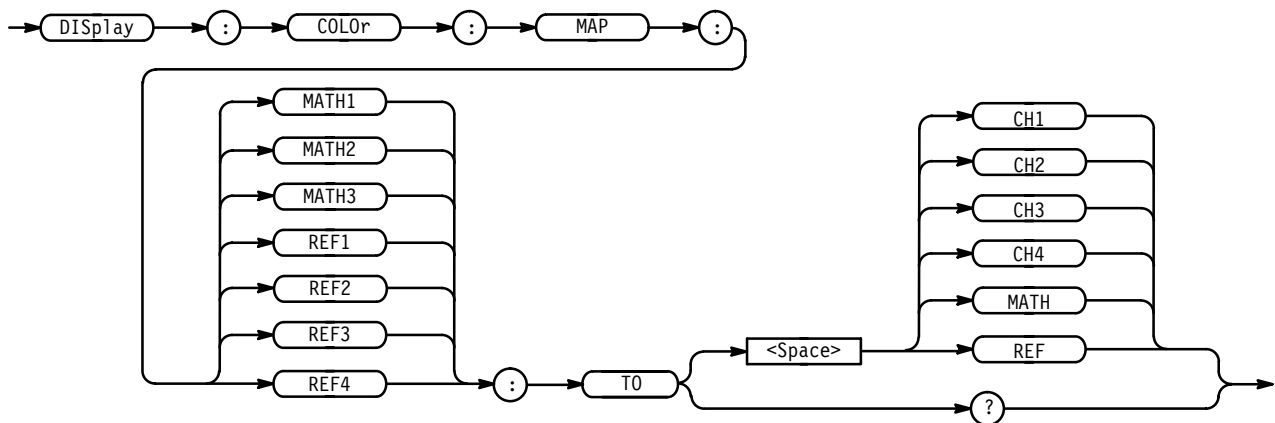

Examples DISPLAY:COLOR:MAP:MATH1:TO CH3
sets the color of math waveform # 1 to that assigned to channel 3. Note: this assumes that **Color Matches Contents** is set of **OFF**.

DISPLAY:COLOR:MAP:MATH1:TO?
might return CH3.

DISplay:COLOr:PALEtte:PERSiStence

TDS 5X4A, 6X4A, & 7XXA Only

Sets the current persistence palette to one of the preset persistence palettes. This is equivalent to selecting **Palette** from the main Color menu, **Persistence Palettes** from the resulting side menu, and **Temperature, Spectral, or Gray Scale** from the next side menu.

Group Display

Syntax DISplay:COLOr:PALEtte:PERSiStence { TEMPErature | SPECTra1 | GRAYscale }

DISplay:COLOr:PALEtte:PERSiStence?

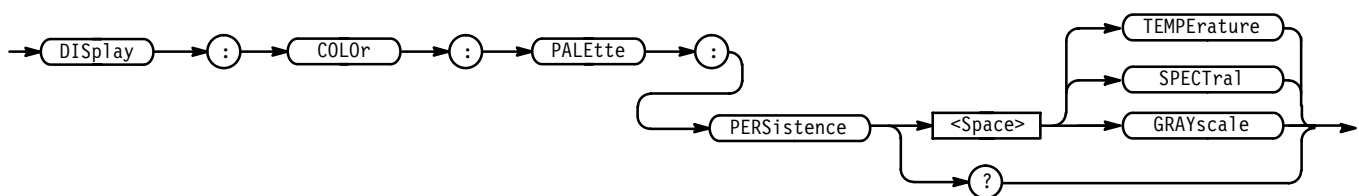

Examples DISPLAY:COLOR:PALETTE:PERSISTENCE TEMPERATURE
sets temperature palette as the current persistence palette.

DISplay:COLOr:PALEtte:REGular

TDS 5X4A, 6X4A, & 7XXA Only

Sets the current palette to one of the preset palettes. This is equivalent to selecting **Palette** from the main Color menu and **Normal, Bold, Hardcopy, or Monochrome** from the resulting side menu.

Group Display

Syntax DISplay:COLOr:PALEtte:REGular { NORMa1 | BOLd | HARDCopy | MONo }

DISplay:COLOr:PALEtte:REGular?

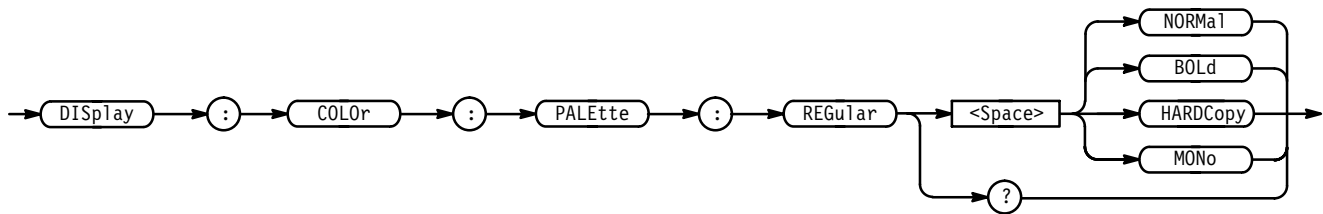

Examples `DISPLAY:COLOR:PALETTE:REGULAR HARDCOPY`
sets the current palette to the hardcopy palette.

DISpIay:COLOr:PALEtte:RESEtALL (No Query Form)

TDS 5X4A, 6X4A, & 7XXA Only

Restores all palettes to their factory default setting. This is equivalent to selecting **Restore Colors** from the main Color menu and **Reset All Palettes to Factory** from the resulting side menu.

Group Display

Syntax `DISpIay:COLOr:PALEtte:RESEtALL`



Examples `DISPLAY:COLOR:PALETTE:RESEtALL`
resets the palette to the factory default setting.

DISpIay:COLOr:PALEtte:<palette name>:RESEt (No Query Form)

TDS 5X4A, 6X4A, & 7XXA Only

Restores the given palette to its factory defaults. This is useful if you have edited the colors in a palette. This is equivalent to selecting **Restore Colors** from the main Color menu and **Reset Current Palette to Factory** from the resulting side menu.

Group Display

Syntax `DISpIay:COLOr:PALEtte:{ NORMa1 | BOLd | HARDCopy | MONo }:RESEt`

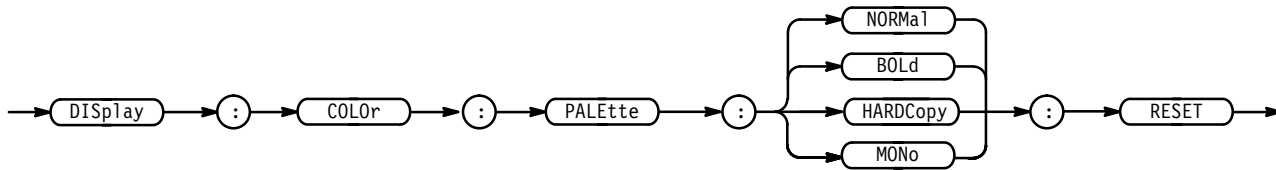

Examples `DISPlay:COLOr:PALEtte:HARDCopy:RESEt`
 resets the hardcopy palette to its initial, factory-default settings.

DISPlay:COLOr:PALEtte:<palette name>:<item name>

TDS 5X4A, 6X4A, & 7XXA Only

Sets the color of a selected item in a selected palette.

Group Display

Syntax `DISPlay:COLOr:PALEtte:{ NORMa1 | MONo | BOLD | HARDCopy }:`
 `{ BACKGround | CH1 | CH2 | CH3 | CH4 | MATH | REF | TEXT |`
 `SCROLLTEXT | ZONE | COLLision | GRATICule | SCROLLBAR }`
 `{ <NR1>,<NR1>,<NR1> }`

`DISPlay:COLOr:PALEtte:{ NORMa1 | MONo | BOLD | HARDCopy }:`
 `{ BACKGround | CH1 | CH2 | CH3 | CH4 | MATH | REF | TEXT |`
 `SCROLLTEXT | ZONE | COLLision | GRATICule | SCROLLBAR }?`

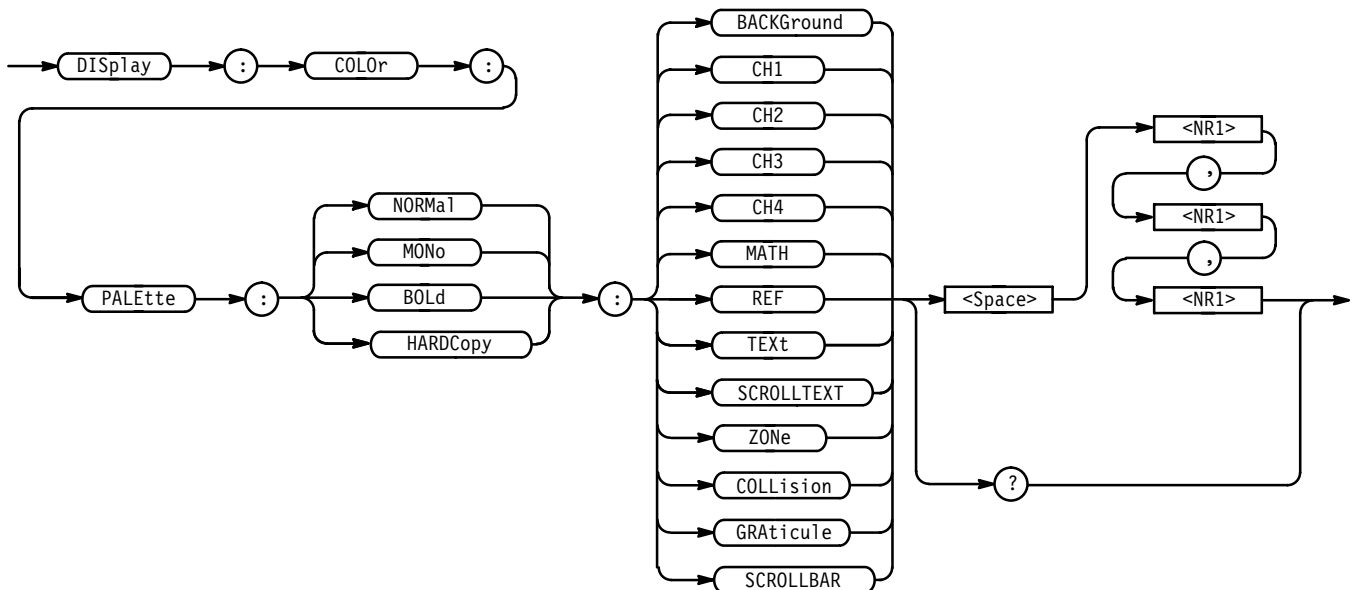

- Arguments**
- BACKGround specifies the display background color.
 - CH1 specifies the channel 1 waveform and associated text color.
 - CH2 specifies the channel 2 waveform and associated text color.
 - CH3 specifies the channel 3 waveform and associated text color.
 - CH4 specifies the channel 4 waveform and associated text color.
 - MATH specifies the default math waveforms and associated text color.
 - REF specifies the default reference waveforms and associated text color.
 - TEXT specifies the text color in all menus and all readouts not associated with a waveform.
 - SCROLLTEXT specifies text in the scroll bar. For example, this covers the scroll bars used in the file system.
 - ZONe specifies the color of the intensified zone on the waveform when the time base is intensified and the color of the real samples when the display style is **Intensified Samples**.
 - COLLision specifies the color of the areas where waveforms overlap each other. You can turn collision marking on or off with the **Items, Waveforms, Options, Collision Contrast** menu item.
 - GRAticule specifies the color of the graticule. Use the **Settings, Display, Graticule** option to select the graticule type.

SCROLLBAR specifies the color of the scrollbar. For example, you will find a scrollbar in various file system menus.

<NR1>, <NR1>, <NR1> specifies the desired colors in terms of hue, lightness and saturation values.

Hue is the wavelength of light reflected from the surface. It varies continuously along the color spectrum as produced by a rainbow. Values range from 0 to 359. Sample values are: 0 = blue, 60 = magenta, 120 = red, 180 = yellow, 240 = green, 360 = cyan.

Lightness refers to the amount of light reflected from the surface. It varies from black, to the nominal color, to white. Values range from 0 to 100. A value of 0 results in black. A value of 50 provides the nominal color. A value of 100 results in white.

Saturation is the intensity of color. Completely desaturated color is gray. Completely saturated color of any hue is that color at its most intense. Values range from 0 to 100. A value of 100 provides a pure color. A value of 0 provides gray.

Examples `DISPLAY:COLOr:PALEtte:HARDCOPY:CH1 120,50,100`
 sets the CH1 color of the hardcopy palette to 120 hue, 50 lightness, and 100 saturation. This provides a pure red.

DISplay:FILTer

Sets or queries the type of interpolation to use for the display when the DISplay:STYle is VECTors. This command is equivalent to setting **Filter** in the Display menu.

Group Display

Related Commands `DISplay:STYle`

Syntax `DISplay:FILTer { LINEAr | SINX }`
`DISplay:FILTer?`

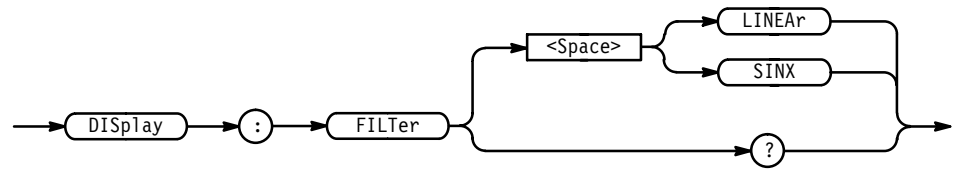

Arguments LINEAr specifies linear interpolation where acquired points are connected with straight lines.

SINX specifies $\sin(x)/x$ interpolation where acquired points are fit to a curve.

Examples DISPLAY:FILTER LINEAR
sets the interpolation filter type to linear.

DISPLAY:FILTER?
returns either LINEAR or SINX, indicating the type of interpolation filter.

DISPlay:FORMat

Sets or queries the display format. This command is equivalent to setting **Format** in the Display menu.

Group Display

Syntax DISPlay:FORMat { XY | YT }

DISPlay:FORMat?

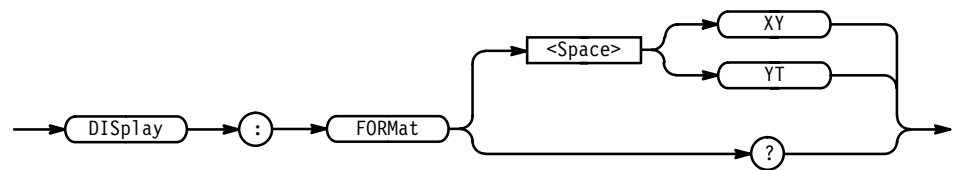

Arguments XY displays the voltage of one waveform against the voltage of another. The sources that make up an XY waveform are predefined and are listed in Table 2–28. Displaying one source causes its corresponding source to be displayed.

Table 2–28: XY Format Pairs

X-Axis Source	Y-Axis Source
Ch 1	Ch 2
Ch 3 (or AUX 1) (All models except TDS 410A)	Ch 4 (or AUX 2) (All models except TDS 410A)
Ref 1	Ref 2
Ref 3	Ref 4

YT sets the display to a voltage versus time format and is the normal mode.

Examples `DISPLAY:FORMAT YT`
 selects a voltage versus time format for the display.

`DISPLAY:FORMAT?`
 might return XY for the display format.

DISplay:GRAticule

Selects the type of graticule that will be displayed. This command is equivalent to setting **Graticule** in the Display menu.

Group Display

Syntax `DISplay:GRAticule { CROSSHair | FRAmE | FULL | GRId | NTSc | PAL }`
`DISplay:GRAticule?`

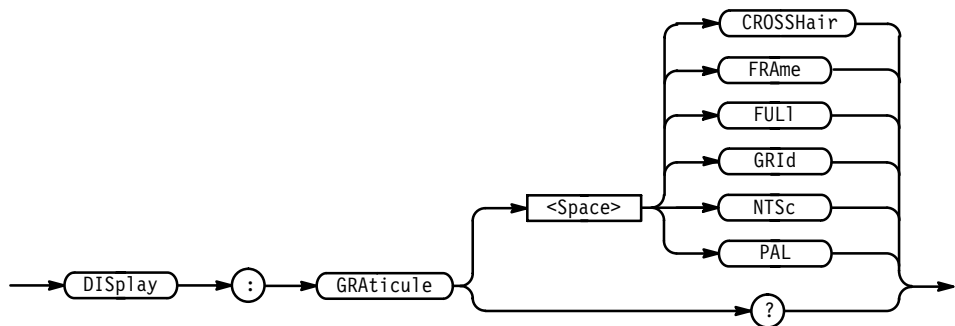

Arguments `CROSSHair` specifies a frame and cross hairs.
`FRAmE` specifies just a frame.

FULL specifies a frame, a grid, and cross hairs.

GRID specifies a frame and a grid.

NTSC specifies a special NTSC frame.

PAL specifies a special PAL frame.

- Examples**
- DISPLAY:GRATICULE GRID
sets the graticule type to display a frame and a grid.
- DISPLAY:GRATICULE?
returns FULL when all graticule elements (grid, frame, and cross hairs) are selected.

DISplay:INSTavu:PERsistence

TDS 7XXA Only

Selects the persistence mode to use with InstaVu.

- Group** Display
- Syntax** DISplay:INSTavu:PERsistence { INFPersist | VARpersist }
DISplay:INSTavu:PERsistence?

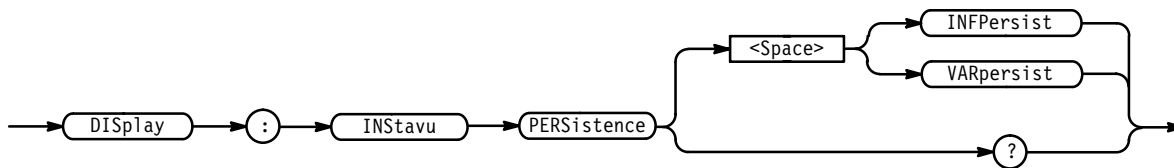

- Arguments**
- INFPersist accumulates data points on the display indefinitely.
- VARpersist leaves acquired data points on the display for a period of time specified by DISplay:INSTavu:VARpersist.

- Examples**
- DISPLAY:INSTAVU:PERSISTENCE?
might return INFPERSIST indicating the infinite persistence mode is on.

DISplay:INSTavu:STYle

TDS 7XXA Only

Selects how the data is displayed with InstaVu.

Group Display

Syntax DISplay:INSTavu:STYle { DOTs | VECTors }
 DISplay:INSTavu:STYle?

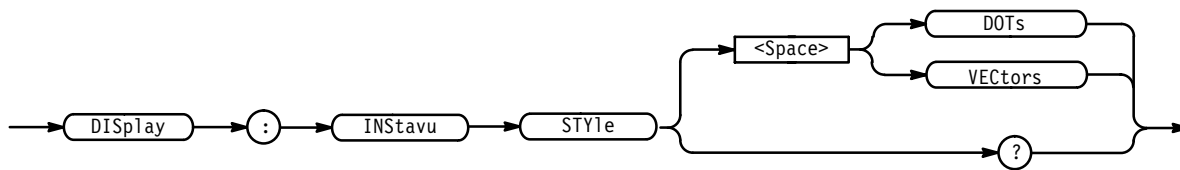

Arguments DOTs displays individual data points.

VECTors connects adjacent data points. Old points are immediately replaced by new ones.

Examples DISPLAY:INSTAVU:STYLE?
 might return DOTs indicating that the display shows individual waveform data points.

DISplay:INSTavu:VARpersist

TDS 7XXA Only

Sets the length of time that data points are displayed when DISplay:INSTavu:PERsistence is set to VARpersist. This affects the display only.

Group Display

Related Commands DISplay:INSTavu:PERsistence

Syntax DISplay:INSTavu:VARpersist <NR3>
 DISplay:INSTavu:VARpersist?

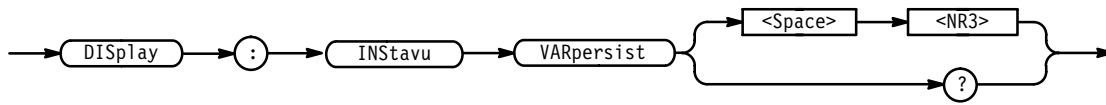

Arguments <NR3> specifies the length, in seconds, that the waveform points are displayed on the screen. The range is 250 ms to 10 s.

Examples DISPLAY:INSTAVU:VARPERSIST 3
specifies that the waveform points are displayed on the screen for 3 seconds before they disappear.

DISplay:INTENSITY? (Query Only)

Returns the current intensity settings for different parts of the display.

Group Display

Syntax DISplay:INTENSITY?

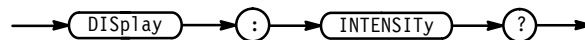

Examples DISPLAY:INTENSITY?
might return :DISPLAY:INTENSITY:WAVEFORM 70;TEXT 60
or :DISPLAY:INTENSITY:OVERALL 85;WAVEFORM 70;TEXT 60;CONTRAST 175

DISplay:INTENSITY:CONTRast

TDS 4X0A, 5X0A & 6X0A Only

Sets the intensity of the intensified zone on a waveform. This command is equivalent to setting **Contrast** in the Display Intensity side menu.

The command has no effect on limit test templates or intensified samples. They are displayed at a fixed contrast ratio.

Group Display

Related Commands HORizontal:MODE

Syntax DISplay:INTENSITY:CONTRast <NR1>

DISplay:INTENSITy:CONTRast?

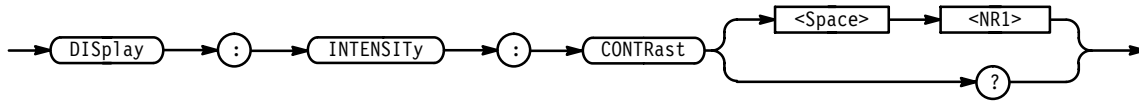

Arguments <NR1> ranges from 100 to 250 percent.

Examples DISPLAY:INTENSITY:CONTRAST 140
sets the intensity of the intensified portion of a waveform.

DISplay:INTENSITy:OVERAll

TDS 4X0A, 5X0A, & 6X0A Only

Sets the intensity of the entire display. This command is equivalent to setting **Overall** in the Display Intensity side menu.

Group Display

Syntax DISplay:INTENSITy:OVERAll <NR1>

DISplay:INTENSITy:OVERAll?

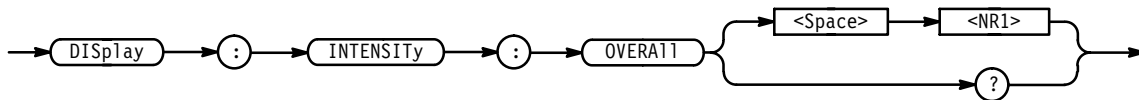

Arguments <NR1> ranges from 20 to 100 percent.

Examples DISPLAY:INTENSITY:OVERALL 50
sets the intensity of the display to the middle of the range.

DISPLAY:INTENSITY:OVERALL?
might return 75 as the overall display intensity.

DISplay:INTENSITy:TEXT

Sets the intensity of the text and the graticule. This command is equivalent to setting **Text/Grat** in the Display Intensity side menu.

Group Display

Syntax DISplay:INTENSITy:TEXT <NR1>
DISplay:INTENSITy:TEXT?

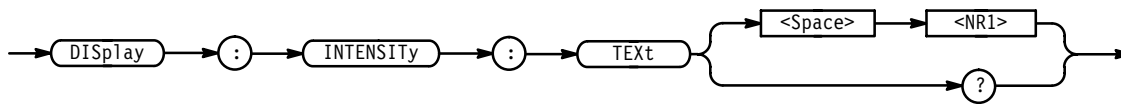

Arguments <NR1> ranges from 20 to 100 percent.

Examples DISPLAY:INTENSITY:TEXT 100
sets the intensity of the text to the brightest level.

DISplay:INTENSITy:WAVEform

Sets the intensity of the waveforms. This command is equivalent to setting **Waveform** in the Display Intensity side menu.

Group Display

Syntax DISplay:INTENSITy:WAVEform <NR1>
DISplay:INTENSITy:WAVEform?

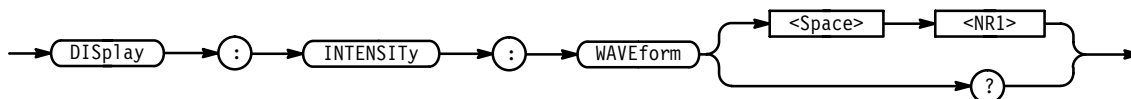

Arguments <NR1> ranges from 20 to 100 percent.

Examples DISPLAY:INTENSITY:WAVEFORM?
might return 60 as the intensity of the waveform.

DISplay:MODE

TDS 7XXA Only

Selects whether or not to turn on InstaVu.

Group Display

Syntax DISplay:MODE { INSTavu | NORMal }
 DISplay:MODE?

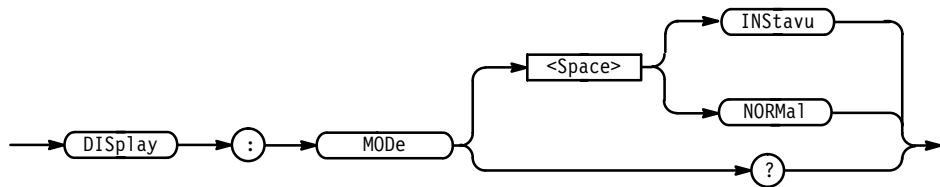

Arguments INSTavu turns on InstaVu. This mode can help view infrequent deviations in a signal. It only uses a 500 point record length, no averaging, and no enveloping.

When you turn on InstaVu, the TDS turns off any active zoom, autosave, limit test, waveform math, FastFrame, and XY display. The TDS reactivates these features when you turn off InstaVu.

NORMal turns on the normal (non-InstaVu mode).

Examples DISPLAY:MODE INSTAVU
 turns on InstaVu.

DISPLAY:MODE?
 might return INSTAVU indicating that the InstaVu mode is on.

DISplay:PERSistence

Sets the length of time that data points are displayed when DISplay:STYLE is set to VARpersist. This affects the display only and is equivalent to setting **Variable Persistence** in the Display Style side menu.

Group Display

Related Commands DISplay:STYLE

Syntax DISplay:PERsistence <NR3>

DISplay:PERsistence?

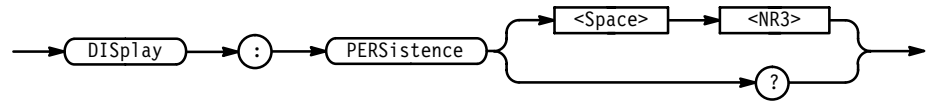

Arguments <NR3> specifies the length, in seconds, that the waveform points are displayed on the screen. The range is 250 ms to 10 s.

Examples DISPLAY:PERSISTENCE 3
 specifies that the waveform points are displayed on the screen for 3 seconds before they fade.

DISplay:STYLE

Selects how the data is displayed. This command is equivalent to setting **Style** in the Display menu.

Group Display

Related Commands DISplay:PERsistence

Syntax DISplay:STYLE { DOTs | INFPersist | INTENSIFied | VARpersist | VECTors }

DISplay:STYLE?

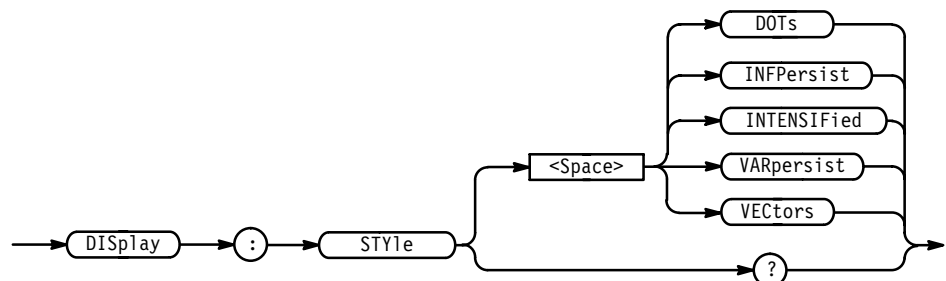

Arguments DOTs displays individual data points.

INFPersist accumulates data points on the display indefinitely. The display is reset when the style or acquisition is reset.

VARpERSist leaves acquired data points on the display for a period of time specified by DISplay:PERsistence.

VEctors connects adjacent data points. Old points are immediately replaced by new ones.

INTENSIFied causes the display to show acquired (non-interpolated) samples with brighter or different colored dots than the rest of the waveform.

Examples

DISPLAY:STYLE INFPERSIST

sets the display to indefinitely accumulate data points on the screen.

DISPLAY:STYLE?

might return DOTS indicating that the display shows individual waveform data points.

DISplay:TRIGBar

Controls the display of the trigger bar indicator/s. The bar indicates where the trigger will occur, in voltage.

The digitizing oscilloscope will only display the bar if the trigger source is also displayed. If both a main and a delayed trigger are displayed, then two bars will appear. One will accompany each source. If a logic trigger is selected, then multiple bars may appear. If a runt pulse trigger is selected, then two bars may appear. One will show the upper threshold and one the lower threshold.

Group Display

Syntax DISplay:TRIGBar { OFF | SHORt | LONG }

DISplay:TRIGBar?

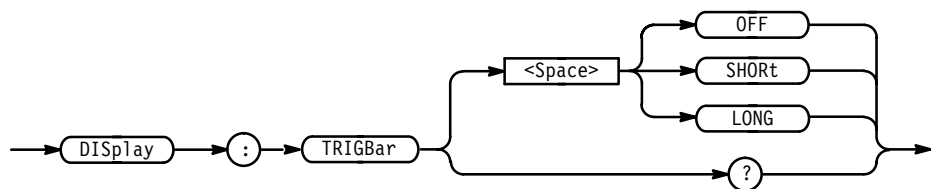

Arguments OFF removes the trigger bar indicator from the display.

SHORt displays a short arrow at the right side of the graticule for each displayed trigger signal.

LONG displays a horizontal line in the center of the graticule for each displayed trigger signal.

Examples DISPLAY:TRIGBAR LONG
sets the display to show long trigger bar indicator (or indicators).

DISplay:TRIGT

Controls the display of the trigger indicator. This is equivalent to setting the **Display 'T' @ Trigger Point** in the Readout Options side menu. The query form returns an ON (1) or an OFF (0).

Group Display

Syntax DISplay:TRIGT { ON | OFF | <NR1> }
DISplay:TRIGT?

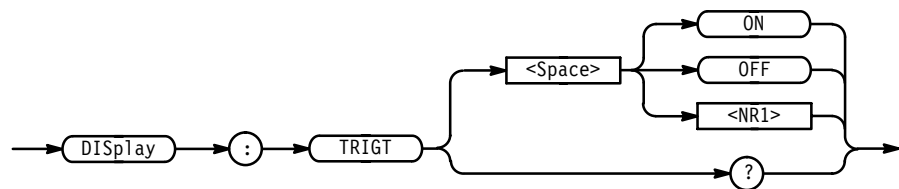

Arguments <OFF> or <NR1> = 0 removes the trigger indicator from the display.
<ON> or <NR1> ≠ 0 displays a trigger indicator on each of the displayed waveforms. The trigger indicator is in reverse video for the selected waveform.

Examples DISPLAY:TRIGT ON
sets the display to show trigger indicators.
DISPLAY:TRIGT?
might return 1 indicating that the display shows trigger indicators.

*ESE

Sets and queries the bits in the Event Status Enable Register (ESER). The ESER prevents events from being reported to the Status Byte Register (STB). For a more detailed discussion of the use of these registers, see page 3–1.

Group Status and Error

Related Commands *CLS, DESE, *ESR?, EVENT?, EVMsg? *SRE, *STB?

Syntax *ESE <NR1>
*ESE?

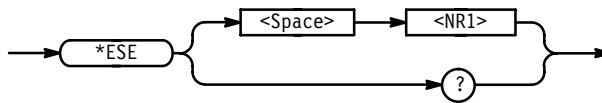

Arguments <NR1> is a value in the range from 0 through 255. The binary bits of the ESER are set according to this value.

The power-on default for ESER is 0 if *PSC is 1. If *PSC is 0, the ESER maintains its value through a power cycle.

NOTE. Setting the *DESER* and the *ESER* to the same value allows only those codes to be entered into the Event Queue and summarized on the *ESB* bit (bit 5) of the Status Byte Register. Use the *DESE* command to set the *DESER*. A discussion of event handling begins on page 3–1.

Examples *ESE 209
sets the ESER to binary 11010001, which enables the PON, URQ, EXE, and OPC bits.

*ESE?
might return the string *ESE 186, showing that the ESER contains the binary value 10111010.

*ESR? (Query Only)

Returns the contents of the Standard Event Status Register (SESR). *ESR? also clears the SESR (since reading the SESR clears it). For a more detailed discussion of the use of these registers, see page 3–1.

Group Status and Error

Related Commands ALLEv?, *CLS, DESE, *ESE, EVENT?, EVMsg?, *SRE, *STB?

Syntax *ESR?



Examples *ESR?

might return the value 213, showing that the SESR contains binary 11010101.

EVENT? (Query Only)

Returns from the Event Queue an event code that provides information about the results of the last *ESR? read. EVENT? also removes the returned value from the Event Queue. A discussion of event handling begins on page 3–1.

Group Status and Error

Related Commands ALLEv?, *CLS, DESE, *ESE, *ESR?, EVMsg?, *SRE, *STB?

Syntax EVENT?



Examples EVENT?

might return the response :EVENT 110, showing that there was an error in a command header.

EVMsg? (Query Only)

Removes from the Event Queue a single event code associated with the results of the last *ESR? read, and returns the event code along with an explanatory message. A more detailed discussion of event handling begins on page 3–1.

Group Status and Error

Related Commands ALLEv?, *CLS, DESE, *ESE, *ESR?, EVENT?, *SRE, *STB?

Syntax EVMsg?

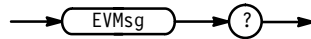

Returns The event code and message in the following format:
 <Event Code><Comma><QString>[<Event Code><Comma><QString>...]
 <QString> ::= <Message>; [<Command>]

where <Command> is the command that caused the error and may be returned when a command error is detected by the digitizing oscilloscope. As much of the command will be returned as possible without exceeding the 60 character limit of the <Message> and <Command> strings combined. The command string is right-justified.

Examples EVMSG?
 might return the message :EVMSG 110,"Command header error".

EVQty? (Query Only)

Returns the number of event codes that are in the Event Queue. This is useful when using the ALLEv? query since it lets you know exactly how many events will be returned.

Group Status and Error

Related Commands ALLEv?, EVENT?, EVMsg?

Syntax EVQty?



Returns <NR1>

Examples EVQTY?
 might return 3 as the number of event codes in the Event Queue.

FACTory (No Query Form)

Resets the digitizing oscilloscope to its factory default settings. This command is equivalent to selecting **Recall Factory Setup** in the Waveform Save/Recall menu.

Group Miscellaneous

Related Commands *PSC, *RCL, RECAI:SETUp, *RST, *SAV, SAVE:SETUp

Syntax FACTory

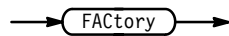

Setting the digitizing oscilloscope to factory default includes:

- Clears the Event Status Enable Register.
- Clears the Service Request Enable Register.
- Sets the Device Event Status Enable Register to 255.
- Sets the Power On Status Clear Flag to TRUE
- Purges all defined aliases.
- Enables all Command Headers (HEADer ON).
- Sets the macro defined by *DDT to a “zero-length field.”
- Clears the pending operation flag and associated operations.

The FACTory command does not alter the following:

- The state of the GPIB (IEEE Std 488.1-1987) interface.
- The selected GPIB address.
- Calibration data that affects device specifications.
- Protected user data.
- Stored settings.
- The current password (if implemented).

FILESystem:COpy (No query form)

File System Only

Copies a named file or files to a new file. The new file may be in a totally separate directory than the old file. Also, you can use wild card characters (*.*) to copy multiple files with one command.

Group File system

Syntax FILESystem:COpy { <source file path>,<destination file path> | <source directory path>,<destination file path> | <source directory path>,<destination directory path> }

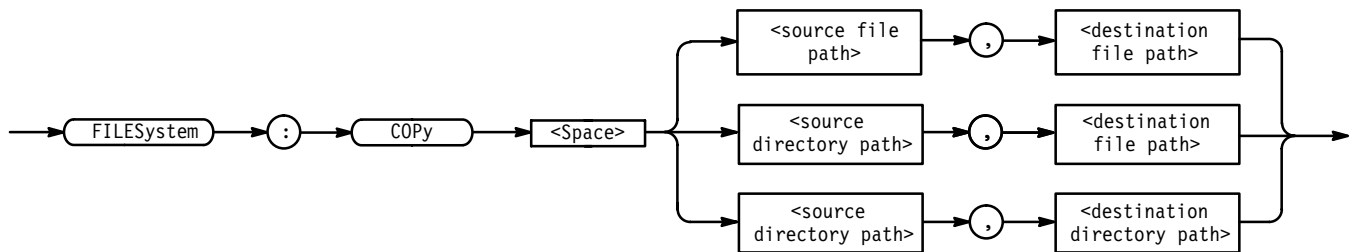

Arguments <file path> is a quoted string that defines the file name and path. Input the file path using the form <drive>/<dir>/<filename>. <drive> and one or more <dir>s are optional. If you do not specify them, the TDS will copy the file in the current directory. <filename> stands for a filename of up to 8 characters and can be followed by a period (".") and a 3-character extension. You can also use the inclusive filename *.* in the source file path to copy all files.

<directory path> is a quoted string that defines the directory. Input the directory using the form <drive>/<dir>/<directory name>. <drive> and one or more <dir>s are optional. If you do not specify them, the TDS will copy the directory in the current directory. <directory name> stands for a directory name of up to 8 characters and can be followed by a period (".") and a 3-character extension.

Examples FILESYSTEM:COPY "TEK00001.SET", "fd0:/TEK00001.SET"
copies the file named TEK00001.SET on the current drive to a file named TEK00001.SET on the drive fd0: in the root directory.

FILESYSTEM:COPY "fd0:/YOURDIR/TEK00001.SET", "fd0:/MYDIR"
copies the file named TEK00001.SET on the fd0: drive and the YOURDIR directory to the MYDIR directory on the same drive.

FILESYSTEM:COPY "YOURDIR", "fd0:/MYDIR"

copies the files in the YOURDIR directory in the current directory to the MYDIR directory on the fd0: drive.

FILESystem:CWD

File System Only

Sets or returns the current working directory (CWD) path.

Group File system

Syntax FILESystem:CWD <directory path>

FILESystem:CWD?

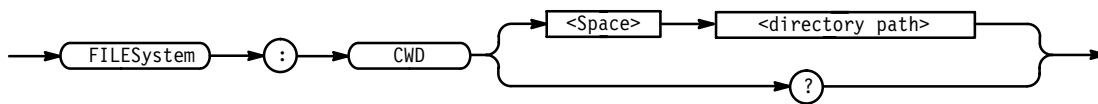

Arguments <directory path> is a quoted string that defines the directory name and path.

Examples FILESYSTEM:CWD "fd0:/MYDIR"
will define fd0:/MYDIR as the current directory.

FILESYSTEM:CWD?
might return fd0:/MYDIR if that is the current directory.

FILESystem:DELEte (No query form)

File System Only

Deletes a named file.

Group File system

Syntax FILESystem:DELEte <file path>

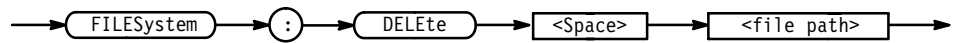

Arguments <file path> is a quoted string that defines the file name and path. Input the file path using the form <drive>/<dir>/<filename>. <drive> and one or more <dir>s are optional. If you do not specify them, the TDS will delete the file in the current directory. <filename> stands for a filename of up to 8 characters and can be followed by a period (“.”) and a 3-character extension. You can also use the inclusive filename *.* to delete all files.

Examples FILESYSTEM:DELETE "NOT-MINE.SET"
 deletes the file named NOT-MINE.SET on the default drive and directory.

FILESYSTEM:DELETE *.*
 deletes all the files in the default directory on the default drive.

FILESystem:DELWarn

File System Only

Turns on or off the front panel file delete warning. No warning is returned via the GPIB.

Group File system

Syntax FILESystem:DELWarn { ON | OFF | <NR1> }
 FILESystem:DELWarn?

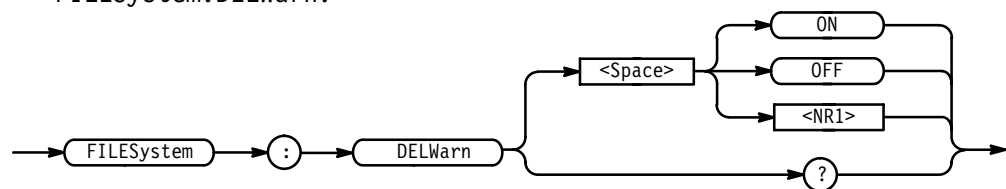

Arguments ON or <NR1> \neq 0 turns on the front panel delete warning.
 OFF or <NR1> = 0 turns off the front panel delete warning.

Examples FILESYSTEM:DELWARN OFF
 disables the front panel delete warning.

FILESYSTEM:DELWARN?
 might return 0 indicating the front panel warning is disabled.

FILESystem:DIR (Query only)

File System Only

Returns a list of quoted strings. Each string contains the name of a file or directory in the current directory.

Group File system

Syntax FILESystem:DIR?

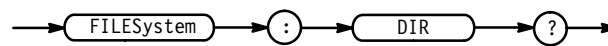

Examples FILESYSTEM:DIR?
returns a list of files and directories in the default directory.

FILESystem:FORMat (No query form)

File System Only

Formats a named drive.

Group File system

Syntax FILESystem:FORMat <drive name>



Arguments <drive name> is a quoted string that defines the disk drive to format. fd0 : refers to the floppy-disk drive built into the digitizing oscilloscope.

Examples FILESYSTEM:FORMAT "fd0:"
formats the media on drive fd0:.

FILESystem:FREEspace (Query only)

File System Only

Returns the amount of freespace (in bytes) on the current drive.

Group File system

Syntax FILESystem:FREESpace?

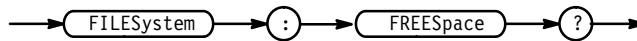

Examples FILESYSTEM:FREESpace?
might return 0 as the amount of freespace available if the drive was full.

FILESystem:MKDir (No query form)

File System Only

Make a new directory.

Group File system

Syntax FILESystem:MKDir <directory path>

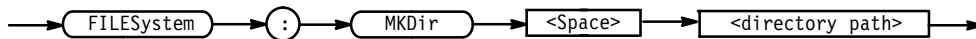

Arguments <directory path> is a quoted string that defines the directory. Input the directory using the form <drive>/<dir>/<directory name>. <drive> and one or more <dir>s are optional. If you do not specify them, the TDS will create the directory in the current directory. <directory name> stands for a directory name of up to 8 characters and can be followed by a period (".") and a 3-char extension.

Examples FILESYSTEM:MKDIR "NEATPICS"
creates the directory named NEATPICS on the current drive.

FILESystem:OVERWrite

File System Only

Turns on or off the file overwrite protection. Turning on file overwrite protection prevents writing over existing files.

Group File system

Syntax FILESystem:OVERWrite { ON | OFF | <NR1> }
 FILESystem:OVERWrite?

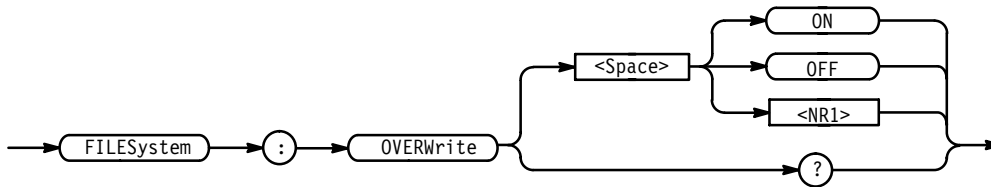

Arguments ON or <NR1> \neq 0 turns on the file overwrite protection.
 OFF or <NR1> = 0 turns off the file overwrite protection.

Examples FILESYSTEM:OVERWRITE OFF
 lets you overwrite existing files.

FILESYSTEM:OVERWRITE?
 might return 0 indicating you cannot overwrite existing files.

FILESystem:PRInt (No query form)

File System Only

Prints a named file to the named port.

Group File system

Syntax FILESystem:PRInt <file path>,{ GPIb | RS232 | CENtronic s }

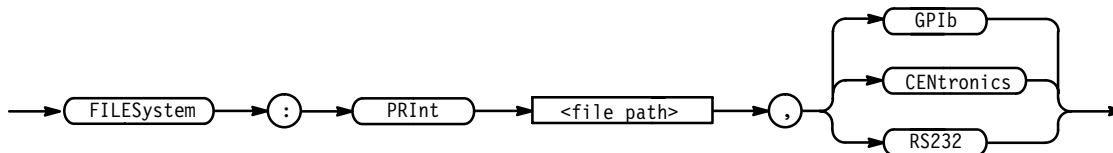

Arguments <file path> is a quoted string that defines the file name and path. Input the file path using the form <drive>/<dir>/<filename>. <drive> and one or more <dir>s are optional. If you do not specify them, the TDS will print the file in the current directory. <filename> stands for a filename of up to 8 characters and can be followed by a period (".") and a 3-character extension.

GPIb specifies that the hardcopy is sent out the GPIB port.

CENtronicS specifies that the hardcopy is sent out the Centronics port (Option 13 RS232/Centronics Hardcopy Interface only).

RS232 specifies that the hardcopy is sent out the RS232 port (Option 13 RS232/Centronics Hardcopy Interface only).

Examples FILESYSTEM:PRINT "TEK00000. IBM",CENTRONICS
sends the file named TEK00000. IBM out the Centronics port.

FILESystem:REName (No query form)

File System Only

Assigns a new name to a file.

Group File system

Syntax FILESystem:REName <old file path>,<new file path>



Arguments <old file path> is a quoted string that defines the file to rename. Input the file path using the form <drive>/<dir>/<filename>. <drive> and one or more <dir>s are optional. If you do not specify them, the TDS will look for the filename in the current directory.

<new file path> is a quoted string that defines the new name of the file. Input the file path using the form <drive>/<dir>/<filename>. <drive> and one or more <dir>s are optional. If you do not specify them, the TDS will place the newly named file in the current directory.

Examples FILESYSTEM:RENAME "TEK00000.SET", "MYSETTING.SET"
gives the file named TEK00000.SET the new name of MYSETTING.SET. The file remains on the current directory.

FILESystem:RMDir (No query form)

File System Only

Deletes a named directory.

Group File system

Syntax FILESystem:RMDir <directory path>

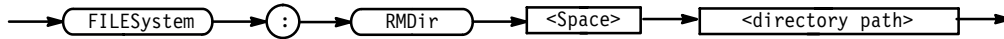

Arguments <directory path> is a quoted string that defines the directory. Input the directory using the form <drive>/<dir>/<directory name>. <drive> and one or more <dir>s are optional. If you do not specify them, the TDS will delete the directory in the current directory. <directory name> stands for a directory name of up to 8 characters and can be followed by a period (".") and a 3-character extension.

Examples FILESYSTEM:RMDIR "NEATPICS"
deletes the directory named NEATPICS in the current directory.

HARDCopy

Sends a copy of the screen display followed by an EOI to the port specified by HARDCopy:PORT. The format and layout of the output is specified with the HARDCopy:FORMat and HARDCopy:LAYout commands. This command is equivalent to pressing the front-panel **HARDCOPY** button.

The HARDCopy? query returns format, layout, and port information.

NOTE. This command is NOT IEEE Std 488.2-1987 compatible.

Group Hardcopy

Syntax HARDCopy { ABOrt | CLEARSpool | START }

HARDCopy?

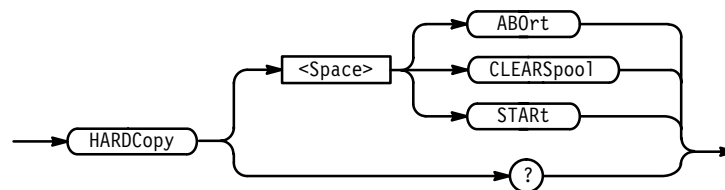

Arguments ABOrt terminates the hardcopy output in process.

NOTE. DCL does NOT clear the output queue once a hardcopy is in process. The only way to abort the hardcopy process is to send the *HARDCopy ABOrt* command. The output queue can then be cleared using *DCL*.

CLEARSpool clears the printer output spooler.

STARt initiates a screen copy that is sent to the controller where it can be stored in a file or redirected to a printing device.

NOTE. Use the **WAI* command between *HARDCopy STARt* commands to ensure that the first hardcopy is complete before starting another.

Examples *HARDCOPY ABORT*
 stops any hardcopy output that is in process.

HARDCopy:FILENAME

File System Only

Selects the file to send the hardcopy data to on the next hardcopy command (*HARDCOPY STARt*). This is equivalent to setting the target file name in the Hardcopy menu.

Group Hardcopy

Related Commands *HARDCopy*

Syntax *HARDCopy:FILENAME <file path>*
HARDCopy:FILENAME?

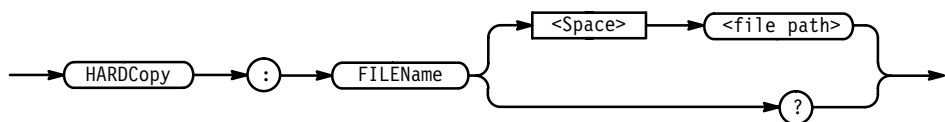

<file path> specifies that the hardcopy is sent to the named file. *<file path>* is a quoted string that defines the file name and path. Input the file path using the form *<drive>/<dir>/<filename>*. *<drive>* and one or more *<dir>*s are optional. If you do not specify them, the TDS will write the file to the current

directory. <filename> stands for a filename of up to 8 characters followed by a period (".") and any 3-character extension.

You can automatically create different names for files. You do this by using the question mark (?) as a special wildcard character. These stand for numbers the TDS will insert sequentially in the filename. For example, if you placed two question marks at the end of the filename then the oscilloscope would append 00 to the first file created, 01 to the next, and 02 to the next. This helps you automatically create different names for files. It is particularly useful in automated testing situations.

Examples

HARDCOPY:FILENAME "TEK.IBM"

selects TEK.IBM as the selected file name.

HARDCOPY:FILENAME?

might return TEK.IBM as the selected file name.

HARDCOPY:FILENAME "TEK?? .IBM"

selects TEK as the selected file name with a numeric, two-digit suffix. The TDS might return TEK00.IBM as the first file, TEK01.IBM as the second.

HARDCopy:FORMat

Selects the output data format for hardcopies. This is equivalent to setting **Format** in the Hardcopy menu.

Group Hardcopy

Syntax HARDCopy:FORMat { BMP | BMPCOLOR (TDS 5XXA, 6XXA, & 7XXA series only) | DESKJet | DPU411 | DPU412 | EPSCOLimg (TDS 5XXA, 6XXA, 744 series only) | EPSColor | EPSImage | EPSMono | EPS0n | HPG1 | INTERLeaf | LASERJet | PCX | PCXCOLOR (TDS 5XXA, 6XXA, & 7XXA series only) | RLE (TDS 5XXA, 6XXA, & 7XXA series only) | THInkjet | TIFF }

HARDCopy:FORMat?

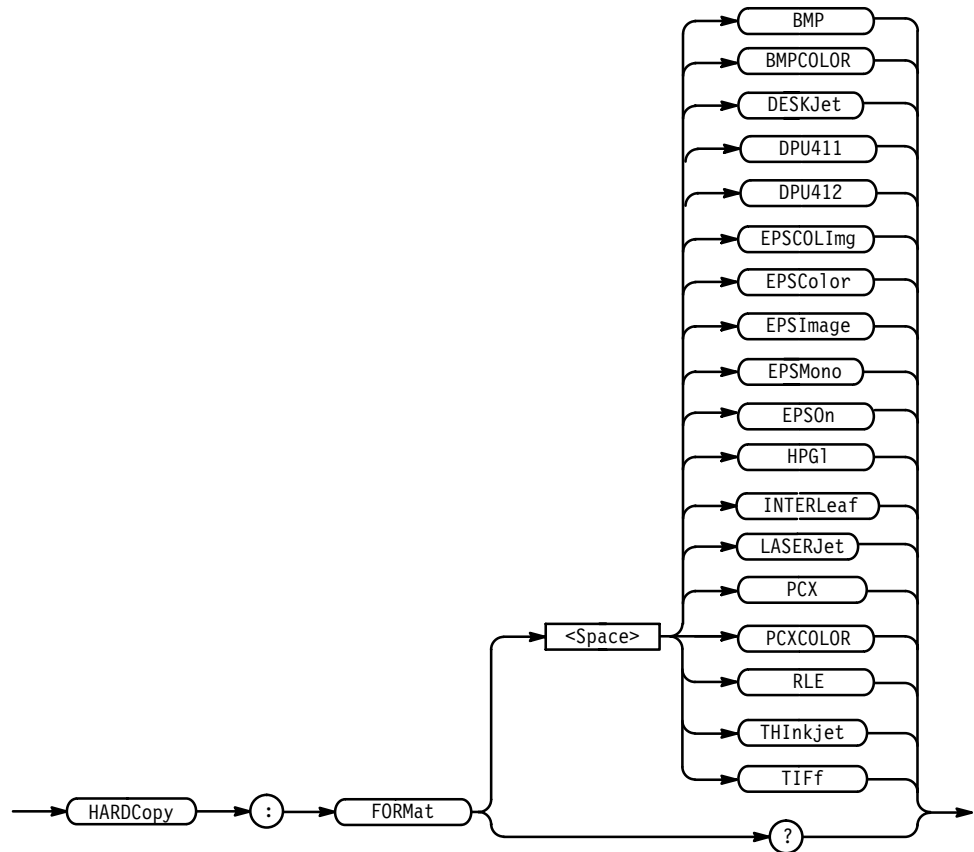

On monochrome instruments (TDS 4X0A, 5X0A & 6X0A series only), the following formats are mapped to a monochrome near equivalent:

PCXCOLOR	→	PCX
BMPCOLOR	→	BMP
RLE	→	BMP
EPSCOLIMG	→	EPSIMAGE

For example: if `HARDCOPY:FORMAT PCXCOLOR` and `HARDCOPY:FORMAT?` are sent to the oscilloscope, PCX is returned.

Examples

`HARDCOPY:FORMAT HPGL`
sets the hardcopy output format to HPGL.

`HARDCOPY:FORMAT?`
might return INTERLEAF as the final hardcopy output format.

HARDCopy:LAYOut

Selects the printing orientation. This is equivalent to setting **Layout** in the Hardcopy menu.

Group Hardcopy

Syntax HARDCopy:LAYOut { LANDscape | PORTRait }

HARDCopy:LAYOut?

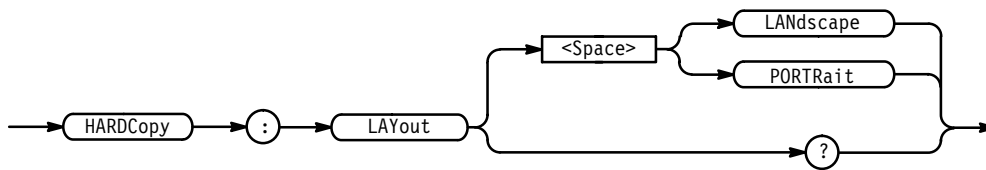

Arguments LANDscape specifies that the bottom of the hardcopy is along the longest side of the page.

PORTRait specifies that the bottom of the hardcopy is along the short side of the page. This is the standard format.

Examples HARDCOPY:LAYOUT?
might return PORTRAIT as the hardcopy page-layout format.

HARDCopy:PALEtte

TDS 5XXA, 6XXA, & 7XXA Only

Selects whether to create the hardcopy using the current color palette (as set in the Display menu and seen on the screen) or the hardcopy palette. For color hardcopies, the default hardcopy palette may be most appropriate, since it has a white background and requires less ink for printing onto white paper. For monochrome hardcopies, the TDS ignores the palette and prints black (or the default color) objects on a blank background.

Group Hardcopy

Related Commands HARDCopy

Syntax HARDCopy:PALEtte { CURRent | HARDCopy }

HARDCopy:PALEtte

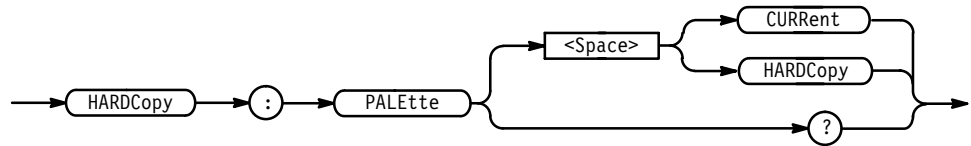

Examples HARDCOPY:PALETTE HARDCOPY
 would print each copy made using the hardcopy palette.

HARDCopy:PORT

Selects where to send the hardcopy data on the next hardcopy command (i.e. HARDCOPY START command). This is equivalent to setting **Port** in the Hardcopy menu.

Group Hardcopy

Related Commands HARDCopy, LIMit:HARDCopy

Syntax HARDCopy:PORT { CENTronics | FILE (File System only) | GPIb | RS232 }

HARDCopy:PORT?

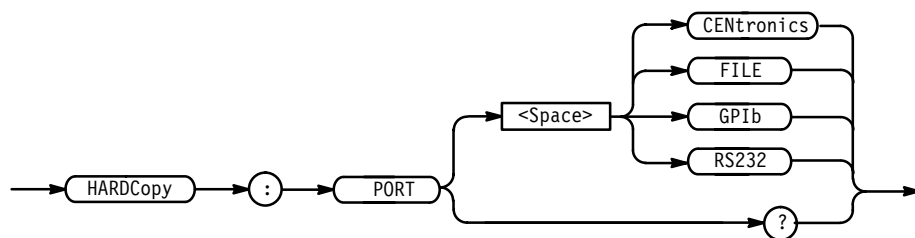

CENTronics specifies that the hardcopy is sent out the Centronics port (available with the RS232/Centronics Hardcopy Interface).

FILE specifies that the hardcopy is stored in the file named in the HARDCOPY:FILENAME command.

GPIb specifies that the hardcopy is sent out the GPIB port.

RS232 specifies that the hardcopy is sent out the RS232 port (Option 13 RS232/Centronics Hardcopy Interface only).

Examples HARDCOPY:PORT?
might return GPIB as the selected hardcopy output port.

HDR

This command is identical to the HEADer query and is included for compatibility with older Tektronix instruments.

Group Miscellaneous

Syntax HDR { <NR1> | OFF | ON }
HDR?

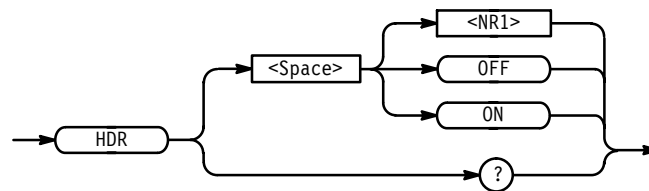

HEADer

Sets and queries the Response Header Enable State that causes the digitizing oscilloscope to either include or omit headers on query responses. This command does not affect IEEE Std 488.2-1987 Common Commands (those starting with an asterisk); they never return headers.

Group Miscellaneous

Related Commands VERBose

Syntax HEADer { <NR1> | OFF | ON }
HEADer?

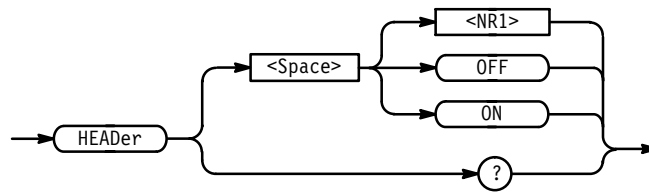

Arguments ON or <NR1> \neq 0 sets the Response Header Enable State to true. This causes the digitizing oscilloscope to include headers on applicable query responses. You can then use the query response as a command.

OFF or <NR1> = 0 sets the Response Header Enable State to false. This causes the digitizing oscilloscope to omit headers on query responses, so that only the argument is returned.

Examples HEADER OFF
causes the digitizing oscilloscope to omit headers from query responses.

HEADER?
might return the value 1, showing that the Response Header Enable State is true.

HORizontal? (Query Only)

Returns all settings for the horizontal commands. The commands HORizontal:MAIn:SCAle, HORizontal:MAIn:SECdiv, HORizontal:SCAle, and HORizontal:SECdiv are equivalent so HORizontal:MAIn:SCAle is the only value that is returned.

Group Horizontal

Syntax HORizontal?

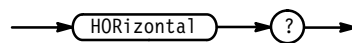

Examples HORIZONTAL?
might return the string :HORIZONTAL:MODE MAIN;RECORDLENGTH 500; POSITION 5.0E+0;TRIGGER:POSITION 50;:HORIZONTAL:MAIN:SCALE 1.0E-6;:HORIZONTAL:DELAY:MODE RUNSAFTER;SCALE 1.0E-6;TIME: 16.0E-9

HORizontal:CLock

TDS 4XXA Only

Enables either the internal or external clocks. The query returns whether the clock is set to internal or external.

Group Horizontal

Syntax HORizontal:CLock { INTernal | EXTernal }
HORizontal:CLock?

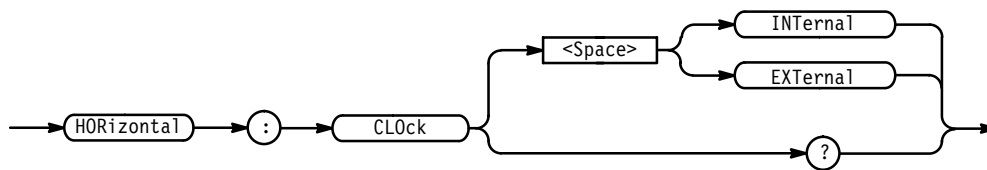

Arguments INTernal enables the internal clock mode.
EXTernal enables the external clock mode.

Examples HORIZONTAL:CLOCK INTERNAL
enables the internal clocks.

HORizontal:CLock:MAXRate

TDS 4XXA Only

Sets the maximum external clock rate. It does not enable the external clock. The maximum external clock rate affects the decimation rate in Hi-Res mode.

If set to less than or equal to 1000, this command enables roll mode when external clock is on and roll more is set to auto.

Group Horizontal

Syntax HORizontal:CLock:MAXRate <NR3>
HORizontal:CLock:MAXRate?

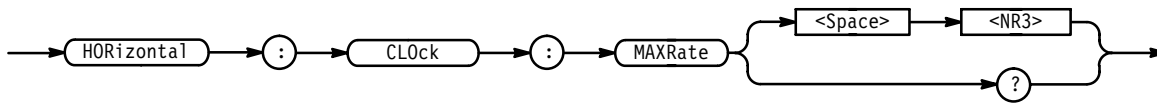

Arguments <NR3> is rounded up to the nearest allowable external clock rate.

Examples HORIZONTAL:CLOCK:MAXRATE 50
sets the maximum external clock rate to 50 clocks per second.

HORIZONTAL:DELAY? (Query Only)

Returns all horizontal delayed time base parameters. The commands HORIZONTAL:DELAY:SECdiv and HORIZONTAL:DELAY:SCALE are identical so only HORIZONTAL:DELAY:SCALE will be returned.

Group Horizontal

Related Commands HORIZONTAL?, HORIZONTAL:DELAY:MODE?, HORIZONTAL:DELAY:SCALE?, HORIZONTAL:DELAY:SECdiv?, HORIZONTAL:DELAY:TIME?

Syntax HORIZONTAL:DELAY?

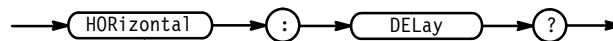

Examples HORIZONTAL:DELAY?
might return the delay parameters :HORIZONTAL:DELAY:MODE RUNSAFTER;SCALE 1.0E-6;TIME: 16.0E-9

HORIZONTAL:DELAY:MODE

Selects the mode for the delayed time base. This is equivalent to setting **Time Base** in the Horizontal menu.

Group Horizontal

Related Commands HORIZONTAL:DELAY:TIME

Syntax HORIZONTAL:DELAY:MODE { RUNSAfter | TRIGAFTER }

HORizontal:DELay:MODE?

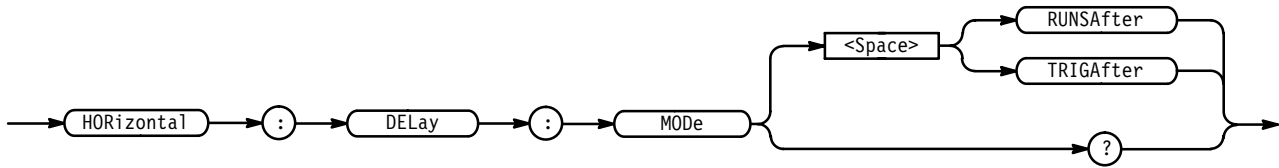

- Arguments** RUNSAfter specifies that the delayed time base runs a user-specified amount of delay time after the main trigger event.
- TRIGAfter specifies that the delayed time base is triggerable after the main time base triggers.

Examples HORizontal:DELAY:MODE?
returns either RUNSAFTER or TRIGAFTER, indicating the delayed time base mode.

HORizontal:DELay:SCALE

Sets the time per division for the delayed time base. This is equivalent to setting **Delayed Scale** in the Horizontal Scale side menu.

On the TDS 4XXA, changes made while the external clock is enabled do not take effect until the internal clock is enabled. Also, when the external clock is enabled, the query form of this command returns an <NR3> value representing '50'.

Group Horizontal

Related Commands HORizontal:DELay:SECdiv

Syntax HORizontal:DELay:SCALE <NR3>
HORizontal:DELay:SCALE?

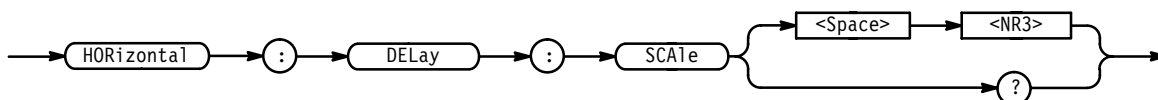

- Arguments** <NR3> is the time per division. The range is 10 s (5 s on the TDS 620A, 640A, and 644A and 20 s on the TDS 4XXA) to 500 ps (1 ns on the TDS 4XXA and 200 ps on the TDS 784A) in a 1–2–5 sequence. Values that are not in a 1–2–5

sequence (1–2.5–5 on the TDS 620A, 640A, & 644A) will be set to the closest valid value. If the delayed time base scale is set slower than the main time base scale, both the main and delayed time base scales will be set to the delay scale value.

- Examples**
- `HORIZONTAL:DELAY:SCALE 2.0E-6`
sets the delay scale to 2 μ s per division.
- `HORIZONTAL:DELAY:SCALE 9.0E-6`
sets the delay scale to 10 μ s per division. Since 9 μ s is not a valid value within the 1–2–5 sequence (1–2.5–5 on the TDS 620A, 640A, & 644A), it is automatically set to the closest valid value.
- `HORIZONTAL:DELAY:SCALE?`
might return 1.0E-3, indicating that the delay time is 1 ms per division.

HORizontal:DELay:SECdiv

This command is identical to the HORizontal:DELay:SCAle command. It is provided to maintain program compatibility with some older models of Tektronix digitizing oscilloscopes.

- Group** Horizontal
- Syntax** `HORizontal:DELay:SECdiv <NR3>`
`HORizontal:DELay:SECdiv?`

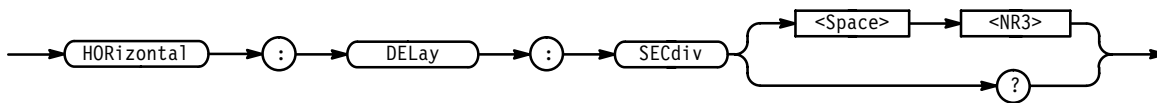

HORizontal:DELay:TIME

Sets or queries the delay time to wait after the main trigger before the delayed time base begins. This is equivalent to setting **Delayed Runs After Main** in the **Time Base** side menu of the Horizontal menu.

- Group** Horizontal
- Related Commands** `HORizontal:DELay:MODE`

Syntax HORizontal:DELay:TIME <NR3>

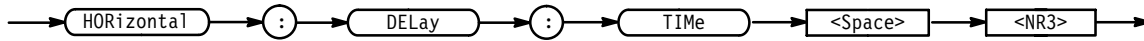

Arguments <NR3> is the time, in seconds, between the main trigger and the delayed trigger. The range on the TDS 5XXA, 6XXA, & 7XXA is from 16 ns to 250 seconds with a resolution of 4 ns. The range on the TDS 4XXA is from 10 ns to 20 seconds with a resolution of 10 ns.

Examples HORIZONTAL:DELAY:TIME 2.0E-3
sets the delay time between the main and delayed time base to 2 ms.

HORizontal:DELay:TIME? (Query Only)

Returns the delay time parameters.

Group Horizontal

Related Commands HORizontal:DELay:TIME:RUNSAfter?, HORizontal:DELay:TIME:TRIGAfter?

Syntax HORizontal:DELay:TIME?

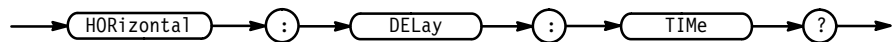

Examples HORIZONTAL:DELAY:TIME?
might return :HORIZONTAL:DELAY:TIME:16.0E-9 for the delay time.

HORizontal:DELay:TIME:RUNSAfter

Sets or queries the delay time to wait after the main trigger before the delayed time base begins. This is equivalent to setting **Delayed Runs After Main** in the **Time Base** side menu of the Horizontal menu.

Group Horizontal

Related Commands HORizontal:DELay:MODE

Syntax HORizontal:DELay:TIME:RUNSAfter <NR3>

HORizontal:DELay:TIME:RUNSAfter?

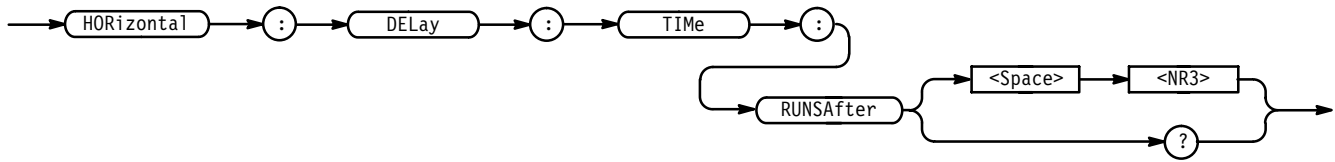

Arguments <NR3> is the time, in seconds, between the main trigger and the delayed trigger. The range is from 16 ns (10 ns on the TDS 4XXA) to 250 seconds (20 s on the TDS 4XXA) with a resolution of 4 ns.

Examples HORIZONTAL:DELAY:TIME:RUNSAFTER 2.0E-3
sets the delay time between the main and delayed time base to 2 ms.

HORizontal:DELay:TIME:TRIGAAfter

Sets the delay time to wait in the trigger after delay mode. This is the time that must pass before a delayed trigger is accepted. This command is equivalent to setting **Delay by Time** time in the Delayed Trigger menu.

Group Horizontal

Related Commands HORizontal:DELay:MODE

Syntax HORizontal:DELay:TIME:TRIGAAfter <NR3>
HORizontal:DELay:TIME:TRIGAAfter?

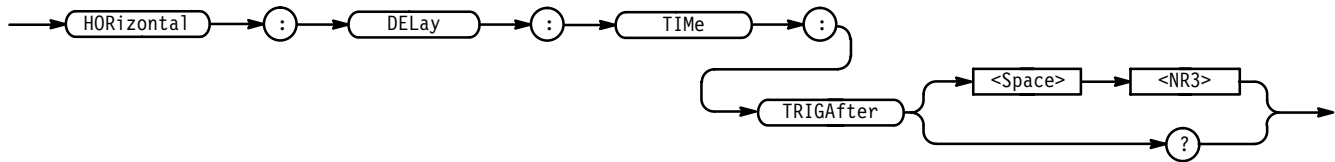

Arguments <NR3> is the delay time, in seconds. The range is from 16 ns (60 ns on the TDS 4XXA) to 250 seconds (20 s on the TDS 4XXA) with a resolution of 4 ns (10 ns down to 110 ns on the TDS 4XXA).

Examples HORIZONTAL:DELAY:TIME:TRIGAFTER 4.0E-6
sets the delay time to 4 μs.

HORIZONTAL:DELAY:TIME:TRIGAFTER?
might return 1.000E-3, indicating that the delay time is 1 ms.

HORizontal:FASTframe:COUNT

TDS 5XXA & 7XXA Only

Sets or queries FastFrame frame count. This is equivalent to setting **FastFrame Setup** in the Horizontal menu and the **Frame Count** menu item in the side menu. FastFrame, also known as memory segmentation, captures a series of triggered acquisitions with minimal, intervening, time.

Group Horizontal

Syntax HORizontal:FASTframe:COUNT <NR1>
HORizontal:FASTframe:COUNT?

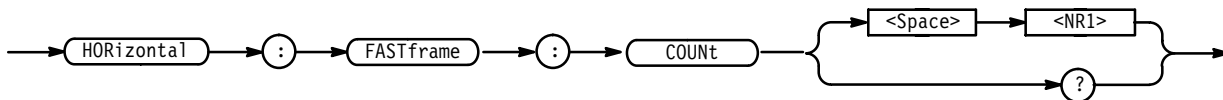

Arguments <NR1> indicates the number of frames to acquire.

Examples HORIZONTAL:FASTFRAME:COUNT 2
Sets up FastFrame mode to acquire two frames (segments) of data.

HORizontal:FASTframe:LENGth

TDS 5XXA & 7XXA Only

Setup length of each FastFrame frame. This is equivalent to setting **FastFrame Setup** in the Horizontal menu and the **Frame Length** menu item in the side menu. FastFrame, also known as memory segmentation, lets users capture a series of triggered acquisitions with minimal, intervening, time between them.

Group Horizontal

Syntax HORizontal:FASTframe:LENGth <NR1>
HORizontal:FASTframe:LENGth?

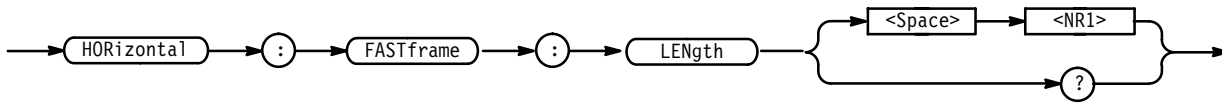

Arguments <NR1> indicates the frame (segment) length.

Examples HORIZONTAL:FASTFRAME:LENGTH 250
Sets up the FastFrame mode to acquire frames of 250 samples each.

HORizontal:FASTframe:POSition

TDS 5XXA & 7XXA Only

Display the selected FastFrame frame. This is equivalent to selecting **Horiz Pos** in the Horizontal menu, selecting the **Frame** menu item in the side menu, and entering a value with the keypad or the general purpose knob. FastFrame, also known as memory segmentation, lets users capture a series of triggered acquisitions with minimal, intervening, time between them.

Group Horizontal

Syntax HORIZONTAL:FASTFRAME:POSITION <NR1>
HORIZONTAL:FASTFRAME:POSITION?

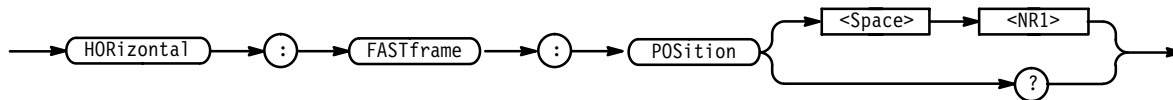

Arguments <NR1> indicates the selected frame to display.

Examples HORIZONTAL:FASTFRAME:POSITION 25
Selects the 25th FastFrame frame to display.

HORizontal:FASTframe:STATE

TDS 5XXA & 7XXA Only

Setup FastFrame acquisition. This is equivalent to setting **FastFrame Setup** in the Horizontal menu and the **FastFrame** menu item in the side menu. Fast-Frame, also known as memory segmentation, lets users capture a series of triggered acquisitions with minimal time between them.

The digitizing oscilloscope in FastFrame mode is ready to accept a continuous burst of triggers 400 ms after the controller sends the `acquire:state run` command.

Group Horizontal

Syntax `HORizontal:FASTframe:STATE { <NR1> | OFF | ON }`
`HORizontal:FASTframe:STATE?`

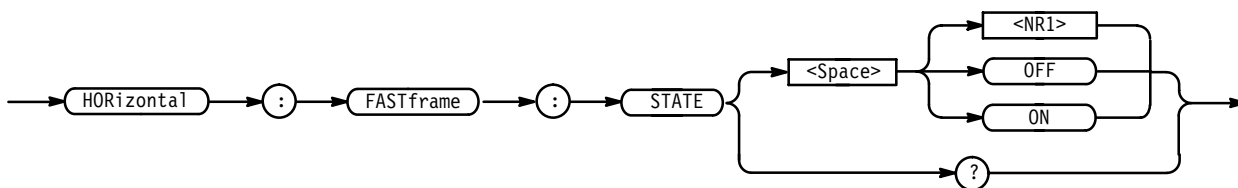

Arguments <NR1> indicates OFF if it's a 0 or ON if it's a 1 (or any other nonzero value).

ON means turn on FastFrame.

OFF means turn off FastFrame.

The query form only returns 0 or 1.

Examples `HORIZONTAL:FASTFRAME:STATE ON`
 turns on FastFrame.

HORizontal:FITtoscreen

Setup horizontal waveform compress operation. This command is equivalent to setting **Record Length** in the Horizontal menu and the **Fit to screen** menu item in the side menu. Waveform compress lets you fit a captured waveform to the visible screen. It provides the same functionality as if you were in zoom mode and changed the time per division until the waveform fit the screen.

Group Horizontal

Syntax `HORizontal:FITtoscreen { <NR1> | OFF | ON }`
`HORizontal:FITtoscreen?`

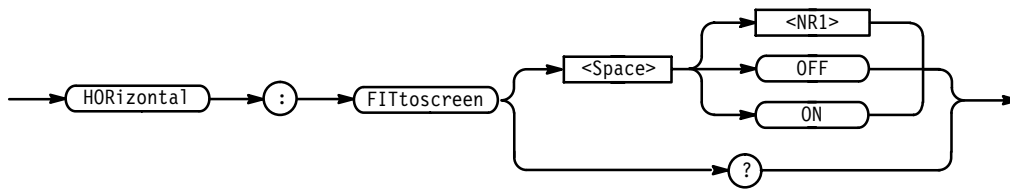

Arguments <NR1> indicates OFF if it's a 0. It indicates ON if it's a non-zero value.
 ON means turn on waveform compress.
 OFF means turn off waveform compress.

Examples HORIZONTAL:FITTOSCREEN ON
 turns on waveform compress.

HORizontal:MAIn? (Query Only)

Returns the time per division of the main time base. The commands HORizontal:MAIn:SECdiv and HORizontal:MAIn:SCALE are identical so only HORizontal:MAIn:SCALE will be returned.

Group Horizontal

Related Commands HORizontal:SCALE, HORizontal:SECdiv, HORizontal:MAIn:SECdiv

Syntax HORizontal:MAIn?

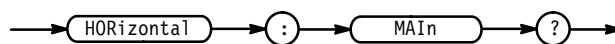

Examples HORIZONTAL:MAIN?
 might return :HORIZONTAL:MAIN:SCALE 1.0E-6.

HORizontal:MAIn:SCALE

Sets the time per division for the main time base. This command is equivalent to setting **Main Scale** in the Horizontal Scale side menu.

On the TDS 4XXA, changes made while the external clock is enabled do not take effect until the internal clock is enabled. Also, when the external clock is enabled, the query form of this command returns an <NR3> value representing '50'.

Group Horizontal

Related Commands HORizontal:DELay:SCAle, HORizontal:DELay:SECdiv, HORizontal:MAIn:SECdiv

Syntax HORizontal:MAIn:SCAle <NR3>
HORizontal:MAIn:SCAle?

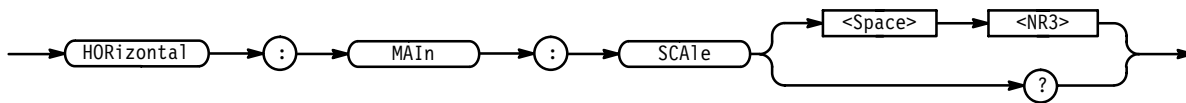

Arguments <NR3> is the time per division. For the TDS 6XXA series (except the 684A), the range is 5 s to 500 ps in a 1–2.5–5 sequence). For the TDS 5XXA series, 684A, and 7XXA, the range is 10 s to 500 ps (or 200 ps on the TDS 784A), in a 1–2–5 sequence. For the TDS 4XXA series, the range is 20 s to 1 ns.

Examples HORIZONTAL:MAIN:SCALE 2E-6
sets the main scale to 2 μ s per division.

HORizontal:MAIn:SECdiv

Sets the time per division for the main time base. This command is identical to the HORizontal:MAIn:SCAle command. It is provided to maintain program compatibility with some older models of Tektronix digitizing oscilloscopes.

Group Horizontal

Related Commands HORizontal:DELay:SCAle, HORizontal:DELay:SECdiv, HORizontal:MAIn:SCAle

Syntax HORizontal:MAIn:SECdiv <NR3>
HORizontal:MAIn:SECdiv?

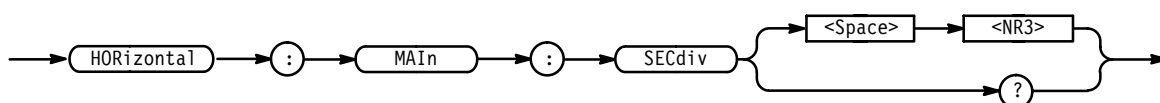

HORizontal:MODE

Selects whether the horizontal display uses the main or delayed time base or both. This command is equivalent to setting **Time Base** in the Horizontal menu.

Group Horizontal

Related Commands DISplay:INTENSITY:CONTRast

Syntax HORizontal:MODE { DELAYEd | INTENSIFied | MAIn }
 HORizontal:MODE?

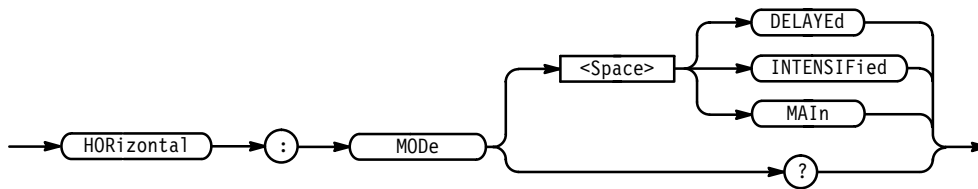

Arguments DELAYEd means that the selected waveform is horizontally scaled relative to the delayed time base.

INTENSIFied uses both the main and delay scales to display the waveform. The portion of the waveform that would be displayed in DELAYEd mode is intensified. The level of intensity is set by the DISplay:INTENSITY:CONTRast command.

MAIn means that the waveform is horizontally scaled relative to the main time base.

Examples HORIZONTAL:MODE DELAYED
 uses the delayed horizontal scale to display the waveform.

HORIZONTAL:MODE?
 might return INTENSIFIED, indicating that the waveform is displayed using both the main and delayed time base scale.

HORizontal:POSition

Positions the waveform horizontally on the display. This is used for both main and delayed time bases. This command is equivalent to adjusting the front-panel **Horizontal Position** knob or setting the position in the Horizontal Position side menu.

Group Horizontal

Syntax HORizontal:POSition <NR3>
HORizontal:POSition?

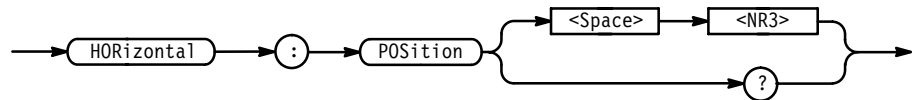

Arguments <NR3> is from 0 to 100, and is the percent of the waveform that is displayed left of the center graticule.

Examples HORIZONTAL:POSITION 10
sets the horizontal position of the waveform such that 10% of the waveform is to the left of screen center.

HORizontal:RECOrdlength

Sets the number of data points that are acquired for each record. This is equivalent to setting **Record Length** in the Horizontal menu.

Group Horizontal

Syntax HORizontal:RECOrdlength <NR1>
HORizontal:RECOrdlength?

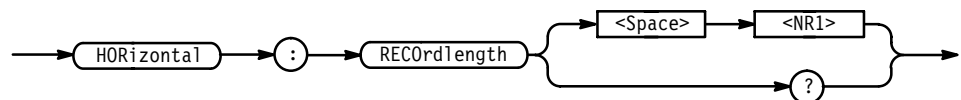

Arguments Table 2–29 shows supported values for <NR1>.

Table 2-30: Record Length Values (<NR1>)

Configuration	TDS 410A, TDS 420A, TDS 460A	TDS 520A, TDS 524A, TDS 540A, TDS 544A	TDS 620A, TDS 640A, TDS 644A	TDS 684A	TDS 744A, TDS 784A
Standard	500, 1000, 2500, 5000, 15000, 30000	500, 1000, 2500, 5000, 15000	500, 1000, 2000	500, 1000, 2500, 5000, 15000	500, 1000, 2500, 5000, 15000, 50000
Option 1M	60000, 120000	50000			75000, 100000, 130000, 250000, 500000

Examples `HORIZONTAL:RECORDLENGTH 2500`
 specifies that 2500 data points will be acquired for each record.

`HORIZONTAL:RECORDLENGTH?`
 might return 15000 as the number of data points per record.

HORizontal:SCAlE

Sets the time per division for the main time base and is identical to the `HORizontal:MAIn:SCAlE` command. It is included here for compatibility purposes.

Group Horizontal

Syntax `HORizontal:SCAlE <NR3>`

`HORizontal:SCAlE?`

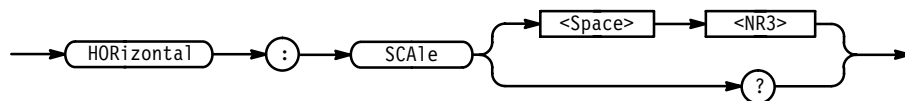

HORizontal:SECdiv

Sets the time per division for the main time base and is identical to the HORizontal:MAIn:SCAle command. It is included here for compatibility purposes.

Group Horizontal

Syntax HORizontal:SECdiv <NR3>
HORizontal:SECdiv?

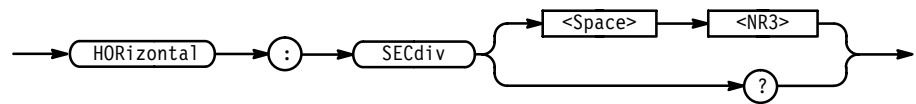

HORizontal:TRIGger? (Query Only)

Returns the horizontal trigger parameter.

Group Horizontal

Syntax HORizontal:TRIGger?

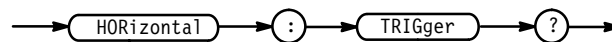

Examples HORIZONTAL:TRIGGER?
might return :HORIZONTAL:TRIGGER:POSITION 50.

HORizontal:TRIGger:POSition

Sets or queries the position of the trigger. This is equivalent to setting **Trigger Position** in the Horizontal menu.

Group Horizontal

Syntax HORizontal:TRIGger:POSition <NR1>
HORizontal:TRIGger:POSition?

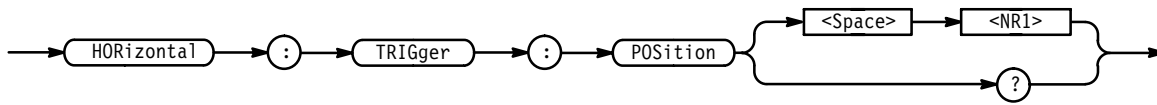

Arguments <NR1> is from 0 to 100 %, (20% to 80% in the TDS 620A, 640A, & 644A) and is the amount of pretrigger information in the waveform.

Examples HORIZONTAL:TRIGGER:POSITION?
might return 50.

ID? (Query Only)

Returns identifying information about the instrument and its firmware.

Group Status and Error

Related Commands *IDN?

Syntax ID?



Returns The instrument id in the following format:

TEK/<model number>,CF:92.1CT,FV:<firmware version number>

Examples ID?
might return TEK/TDS 544A,CF:92.1CT,FV:3.0

*IDN? (Query Only)

Returns the digitizing oscilloscope identification code.

Group Miscellaneous

Related Commands ID

Syntax *IDN?



Returns The instrument id in the following format:
 TEKTRONIX,<model number>,0,CF:92.1CT FV:<firmware version number>

Examples *IDN?
 might return the response
 TEKTRONIX,TDS 544A,0,CF:92.1CT FV:2.0

LIMit:BEL1

Rings the bell when the waveform data exceeds the limits set in the limit test, if the limit state is on.

Group Limit Test

Related Commands LIMit:COMPARE:CH<x>, LIMit:STATE

Syntax LIMit:BEL1 { OFF | ON | <NR1> }
 LIMit:BEL1?

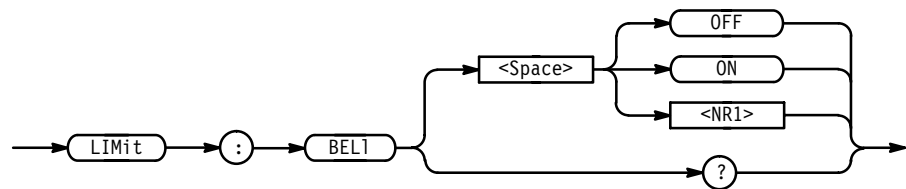

Arguments OFF or <NR1> = 0 turns off ringing the bell when any waveform data exceeds the limits set by the limit test.
 ON or <NR1> ≠ 0 turns on ringing the bell.

Examples LIMit:BEL1 ON
 specifies that the bell is to ring when any waveform data exceeds the limits specified in the limit test.

LIMit:BEL1?

returns either 0 or 1, indicating whether the bell is to ring when any waveform data exceeds the limits specified in the limit test.

LIMit:COMPARE:CH<x>

Sets or queries the template against which to compare the waveform acquired through the specified channel. The template can be a waveform saved in any of the reference locations REF1 through REF4, or none.

Group Limit Test

Related Commands CURve, LIMit:COMPARE:MATH<x>, LIMit:TEMPLate, LIMit:TEMPLate:DESTination, LIMit:TEMPLate:SOUrce, WFMPre

Syntax LIMit:COMPARE:CH<x> { NONE | REF<x> }

LIMit:COMPARE:CH<x>?

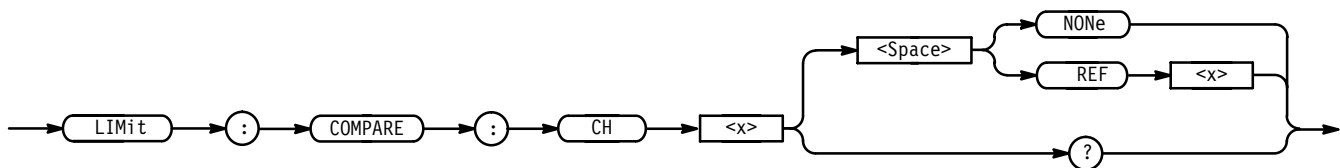

Arguments REF<x> is a reference waveform.

NONE specifies that no template testing is to be done for the specified channel.

Examples

LIMIT:COMPARE:CH1 REF1

specifies REF1 as the template waveform against which to compare waveforms acquired using CH1.

LIMIT:COMPARE:CH2?

might return LIMIT:COMPARE:CH2 REF4, indicating that waveforms acquired using CH2 will be compared to the template waveform stored in REF4.

LIMit:COMPARE:MATH<x>*TDS 5XXA, 6XXA, & 7XXA Only*

Sets or queries the template against which to compare a math waveform. The template can be a waveform saved in any of the reference locations REF1 through REF4, or none.

Group Limit Test

Related Commands CURve, LIMit:TEMPLate, LIMit:TEMPLate:DESTination, LIMit:TEMPLate:SOURce, WFMPre

Syntax LIMit:COMPARE:MATH<x> { NONE | REF<x> }
LIMit:COMPARE:MATH<x>?

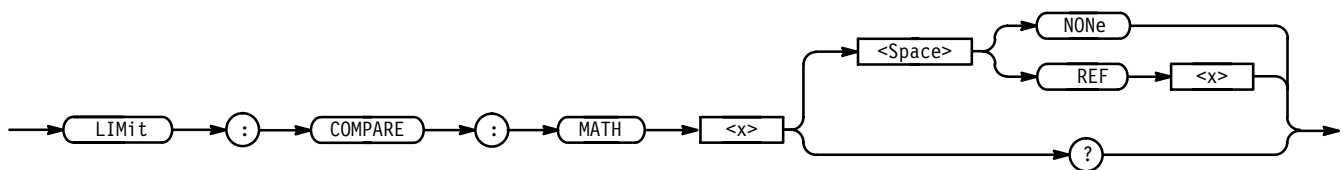

Arguments REF<x> is a reference waveform.

NONE specifies that no template testing is to be done for the specified channel.

MATH<x> is a math waveform.

Examples LIMIT:COMPARE:CH1 REF1
specifies REF1 as the template waveform against which to compare waveforms acquired using CH1.

LIMIT:COMPARE:CH2?
might return LIMIT:COMPARE:CH2 REF4, indicating that waveforms acquired using CH2 will be compared to the template waveform stored in REF4.

LIMit:HARDCopy

Executes a hardcopy operation on the waveform when any waveform data exceeds the limits set in the limit test, if the limit state is on. The hardcopy operation uses the port, and prints in the format and layout, specified using the HARDCopy commands.

Group Limit Test

Related Commands LIMit:COMPARE:CH<x>, LIMit:STATE, HARDCopy

Syntax LIMit:HARDCopy { OFF | ON | <NR1> }
 LIMit:HARDCopy?

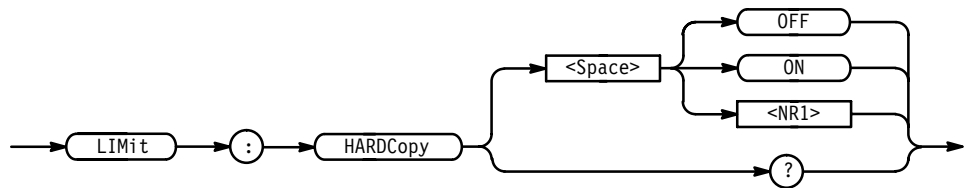

Arguments ON or <NR1> \neq 0 turns on the hardcopy operation for the waveform when any waveform data exceeds the limits set by the limit test.
 OFF or <NR1> = 0 turns off the hardcopy operation.

Examples LIMit:HARDCopy ON
 specifies that the hardcopy operation occurs for the waveform when any waveform data exceeds the limits specified in the limit test.
 LIMit:HARDCopy?
 returns either 0 or 1, indicating whether the hardcopy operation occurs for the waveform when any waveform data exceeds the limits specified in the limit test.

LIMit:STATE

Turns limit testing on or off, or queries whether limit testing is in effect.

Group Limit Test

Related Commands CURve, LIMit:BELI, LIMit:COMPARE:CH<x>, LIMit:HARDCopy, LIMit:TEMPLate, WFMPre

Syntax LIMit:STATE { OFF | ON | <NR1> }
 LIMit:STATE?

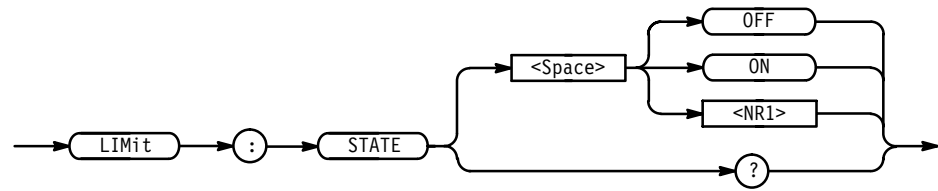

Arguments OFF or <NR1> = 0 turns off limit testing.
ON or <NR1> ≠ 0 turns on limit testing.

Examples LIMit:STATE ON
specifies that limit testing of waveforms is in effect.
LIMit:STATE?
returns either 0 or 1, indicating whether limit testing of waveforms is in effect.

LIMit:TEMPLate (No Query Form)

Creates a template which you can use for limit testing. You can compare the waveform acquired through the specified channel against this template. The template can be a waveform saved in any of the reference locations REF1 through REF4, or none.

Group Limit Test

Related Commands LIMit:TEMPLate:DESTination, LIMit:TEMPLate:SOUrce, LIMit:TEMPLate:TOLerance

Syntax LIMit:TEMPLate STORe

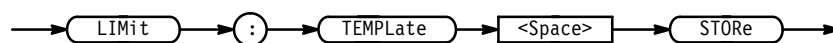

Arguments STORe creates a template with the specified source waveform and tolerances, and stores it in the destination reference waveform to be used in limit testing comparisons.

Examples LIMIT:TEMPLate STORe
creates a template with the specified source waveform and tolerances, and stores it in the destination reference waveform to be used in limit testing comparisons.

LIMit:TEMPLate:DESTination

Sets or queries the destination reference waveform that the LIMit:TEMPLate STORE command will use.

Group Limit Test

Related Commands LIMit:COMPARE:CH<x>, LIMit:TEMPLate, LIMit:TEMPLate:SOUrce

Syntax LIMit:TEMPLate:DESTination REF<x>
LIMit:TEMPLate:DESTination?

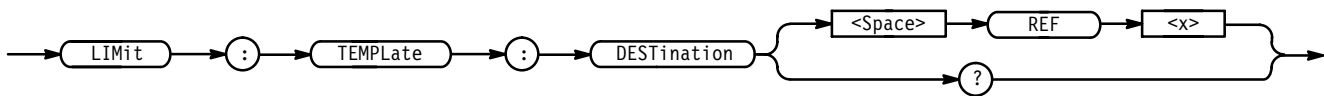

Arguments REF<x> specifies the reference waveform destination in which the template waveform is to be stored.

Examples LIMIT:TEMPLate:DESTination REF2
specifies that the template waveform referred to with the LIMit:TEMPLate STORE command is stored as the REF2 waveform.

LIMit:TEMPLate:SOUrce

Sets or queries the channel, math waveform, or reference waveform that the LIMit:TEMPLate STORE will use.

Group Limit Test

Related Commands LIMit:COMPARE:CH<x>, LIMit:TEMPLate, LIMit:TEMPLate:DESTination

Syntax LIMit:TEMPLate:SOUrce { CH<x> | MATH<x> | REF<x> }
LIMit:TEMPLate:SOUrce?

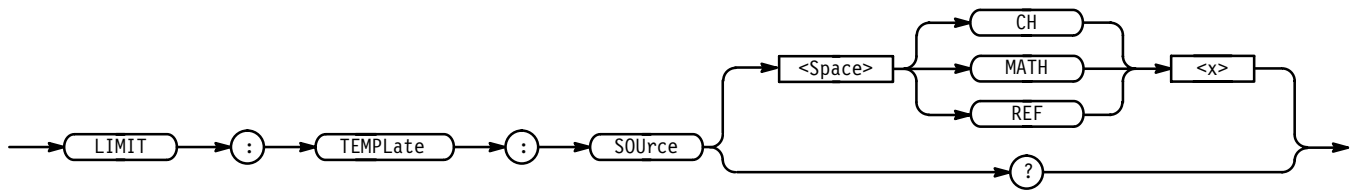

- Arguments**
- CH<x> specifies that the template waveform is the waveform currently being acquired using the specified channel.
- MATH<x> specifies that the template waveform is the waveform currently stored as the specified math waveform.
- REF<x> specifies that the template waveform is the waveform currently stored as the specified reference waveform.

- Examples**
- LIMIT:TEMPLATE:SOURCE CH2
specifies that the template waveform for limit tests is the waveform currently acquired using channel 2.
- LIMIT:TEMPLATE:SOURCE?
might return MATH3, specifying that the template waveform for limit tests is the waveform currently stored as the MATH3 waveform.

LIMit:TEMPLate:TOLerance:HORizontal

Sets or queries the amount, in units of horizontal divisions, by which the source waveform is varied horizontally when creating the destination waveform.

Group Limit Test

Related Commands LIMit:COMPARE:CH<x>

Syntax LIMit:TEMPLate:TOLerance:HORizontal <NR3>

LIMit:TEMPLate:TOLerance:HORizontal?

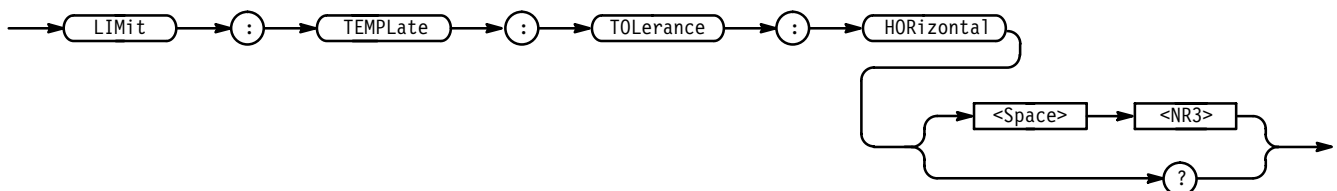

Arguments <NR3> is the amount, in horizontal divisions, by which the current waveform is allowed to deviate from the template waveform without exceeding the limits set in the limit test. The range is 0 to 5 divisions.

Examples `LIMIT:TEMPLate:TOLerance:HORizontal 1.0`
 specifies that the current waveform is deemed to be close enough to the template waveform if it is within ± 1.0 horizontal division.

`LIMIT:TEMPLate:TOLerance:HORizontal?`
 might return `1.0`, specifying that the current waveform is close enough to the template waveform if it is within ± 1.0 horizontal division.

LIMit:TEMPLate:TOLerance:VERTical

Sets or queries the amount, in units of vertical divisions, by which the source waveform is varied vertically when creating the destination waveform.

Group Limit Test

Related Commands `LIMit:COMPARE:CH<x>`

Syntax `LIMit:TEMPLate:TOLerance:VERTical <NR3>`
`LIMit:TEMPLate:TOLerance:VERTical?`

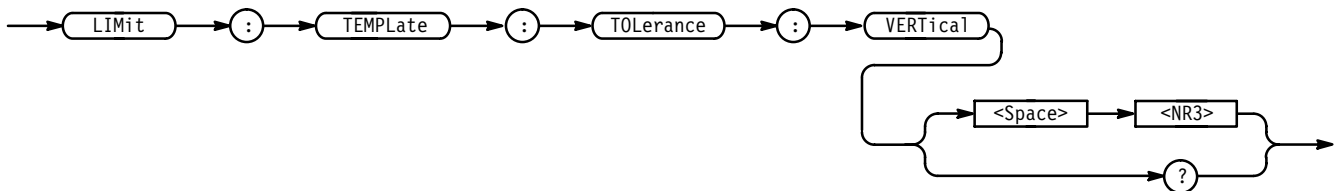

Arguments <NR3> is the amount, in vertical divisions, by which the current waveform is allowed to deviate from the template waveform without exceeding the limits set in the limit test. The range is 0 to 5 divisions.

Examples `LIMIT:TEMPLate:TOLerance:VERTical 1.0`
 specifies that the current waveform is close enough to the template waveform if it is within ± 1.0 vertical division from the template waveform.

`LIMIT:TEMPLate:TOLerance:VERTical?`
 might return `1.0`, specifying that the current waveform is close enough to the template waveform if it is within ± 1.0 vertical division.

LOCK

Enables and disables all front panel buttons and knobs. There is no front-panel equivalent.

Group Miscellaneous

Related Commands UNLOCK, Remote Enable Group, Local Lockout Group

Syntax LOCK { ALL | NONE }
LOCK?

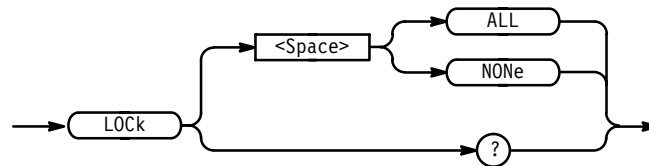

Arguments ALL disables all front panel controls.

NONE enables all front panel controls. This is equivalent to the UNLOCK ALL command.

NOTE. If the digitizing oscilloscope is in the Remote With Lockout State (RWLS), the LOCK NONE command has no effect. For more information see the ANSI-IEEE Std. 488.1-1987 Standard Digital Interface for Programmable Instrumentation, section 2.8.3 on RL State Descriptions.

Examples LOCK ALL
locks the front panel controls.

LOCK?
returns NONE when the front panel controls are enabled by this command.

*LRN? (Query Only)

Returns a string listing the digitizing oscilloscope settings, except for configuration information for the calibration values. You can use this string to return the digitizing oscilloscope to the state it was in when you made the *LRN? query.

Group Miscellaneous

Related Commands HEADer, SET?, VERBose

Syntax *LRN?



NOTE. The *LRN? query always returns a string including command headers, regardless of the setting of the HEADer command. This is because the returned string is intended to be sent back to the digitizing oscilloscope as a command string. The VERBose command can still be used normally to specify whether the returned headers should be abbreviated.

Examples *LRN?
 a partial response might look like this:
 :ACQUIRE:STATE 1;MODE SAMPLE;NUMENV 10;NUMAVG 16;
 REPET 1;STOPAFTER RUNSTOP;;DIAG:LOOP:OPTION ONCE;
 COUNT 1;;DIAG:STATE HALT;;HEADER 1;;VERBOSE 1;
 :CURSOR:FUNCTION OFF;VBARS:UNITS SECONDS;
 POSITION1 1.00E-6;POSITION2 9.00E-6;SELECT CURSOR1;

MATH<x>? (Query Only)

Returns the definition for the math waveform specified by <x>.

Group Vertical

Syntax MATH<x>?

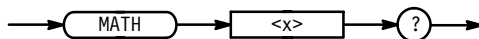

MATH<x>:DEFINE

Allows the user to define new waveforms using mathematical expressions. This is equivalent to selecting **Change Math waveform definition** in the Math<x> side menu.

Group Vertical

Syntax MATH<x>:DEFINE <QString>
MATH<x>:DEFINE?

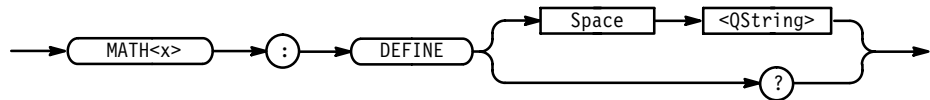

Arguments <QString> contains the mathematical expression. The expression can include any amount of white space. Expressions can be either single or dual waveform expressions. <src> and <function> elements are case independent.

The format for a single waveform expression is:

```
<function>(<source> [, <window>, <scaling>, <phase suppression>])
```

The format for a dual waveform expression is:

```
<source><operator><source>
```

where:

```
<function> ::= INV | DIF | FFT | INT
```

- **INVert** (for invert): inverts the defined waveform.
- **DIFferentiate** (available with Advanced DSP Math only): takes the derivative of the selected waveform.
- **FFT** (available with Advanced DSP Math only): provides an FFT of the selected waveform. It uses the format: “FFT(<source>, <window>, <scaling>, <phase suppression>)” where the window, scaling, and phase suppression arguments in the parentheses are optional. You can specify these arguments in any order.

<source> refers to a signal channel. Valid choices are: CH1, CH2, CH3, CH4, REF1, REF2, REF3, or REF4.

(The TDS 410A does not include CH3 and CH4.)

<window> refers to an FFT window. Valid choices are: RECTangular, HAMming, HANning, or BLAckmanharris.

<scaling> provides vertical scaling. Valid choices are: LOGrms, LINearrms, DEGreesphase, or RADiansphase.

<Phase suppression> is of the range: -100 dB to 100 dB.

- **INTEgrate** (available on instruments with the Option 2F Advanced DSP Math only): takes the integral of the selected waveform.

<operator> ::= { + | - | * | / (not available on TDS 4XXA) }

<source> ::= { CH<x> | REF<x> }

Examples

MATH2:DEFINE "Ch1 + ch2"

adds channel 1 and channel 2, and stores the result in MATH2.

MATH1:DEFINE "INV(ref4)"

inverts the waveform stored in reference memory location 4 storing the result in MATH1.

MATH1:DEFINE "FFT(CH1)"

takes an FFT on the waveform from channel 1 and stores the result in MATH1.

MATH1:DEFINE "FFT(CH1, HAMM, LINEARRMS, 20)"

takes an FFT from channel1, using the HANNING algorithm, with linear rms scaling, and 20 dB phase suppression. The result is stored in MATH1.

MATH1:DEFINE?

might return "Ch2*Ref2" as the expression that defines MATH1.

MATH<x>:NUMAVg

*TDS 5XXA, 6XXA, & 7XXA Only,
some models require Option 2F*

Allows the user to declare at what acquisition number the averaging algorithm will begin exponential averaging. Prior to that acquisition number, the algorithm uses stable averaging. This is equivalent to selecting **Average** in the Math<x> side menu and entering a value with the general purpose knob or the keypad.

Group Vertical

Syntax MATH<x>:NUMAVg <NR1>

MATH<x>:NUMAVg?

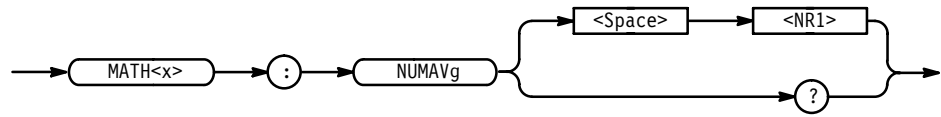

Arguments < NR1 > specifies the number of times to successively average the math waveform before completing an acquisition.

Examples MATH2:NUMAVG 10
 Successively averages math waveform 2 by 10 times.

MATH2:NUMAVG?
 might return 10 indicating 10 math 2 waveforms are successively averaged before a single acquisition occurs.

MATH<x>:PROCessing

*TDS 5XXA, 6XXA, & 7XXA Only,
 some models require Option 2F*

Allows the user to turn on or off averaging for the math waveform specified by <x>. This is equivalent to selecting **No Extended Process** or **Average** in the Math<x> side menu.

Math averaging allows the digitizing oscilloscope to successively average any acquisition-related math waveform. This can help reduce noise in a math waveform.

Group Vertical

Syntax MATH<x>:PROCessing { OFF | AVErage }

MATH<x>:PROCessing?

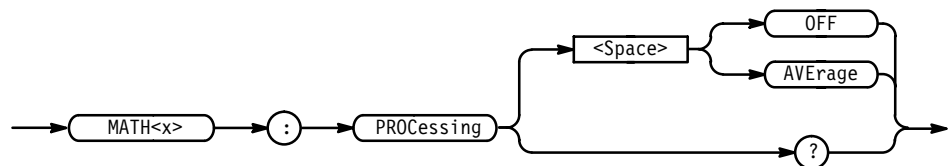

Arguments OFF turns off waveform averaging.
 AVErage turns on waveform averaging.

Examples MATH1:PROCESSING OFF
 ensures that waveform averaging is not in use on math waveform 1.

 MATH1:PROCESSING AVERAGE
 turns on waveform averaging on math waveform 1.

MEASUrement? (Query Only)

Returns all measurement parameters.

Group Measurement

Syntax MEASUrement?

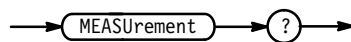

Examples MEASUREMENT?
 might return :MEASUREMENT:MEAS1:STATE 0;TYPE PERIOD;UNITS "s";SOURCE1 CH1;SOURCE2 CH1;DELAY:EDGE1 RISE;EDGE2 RISE;DIRECTION FORWARDS;:MEASUREMENT:MEAS2:STATE 0;TYPE PERIOD;UNITS "s";SOURCE1 CH1;SOURCE2 CH1;DELAY:EDGE1 RISE;EDGE2 RISE;DIRECTION FORWARDS;:MEASUREMENT:MEAS3:STATE 0;TYPE PERIOD;UNITS "s";SOURCE1 CH1;SOURCE2 CH1;DELAY:EDGE1 RISE;EDGE2 RISE;DIRECTION FORWARDS;:MEASUREMENT:MEAS4:STATE 0;TYPE PERIOD;UNITS "s";SOURCE1 CH1;SOURCE2 CH1;DELAY:EDGE1 RISE;EDGE2 RISE;DIRECTION FORWARDS;:MEASUREMENT:IMMED:TYPE PERIOD;UNITS "s";SOURCE1 CH1;SOURCE2 CH1;DELAY:EDGE1 RISE;EDGE2 RISE;DIRECTION FORWARDS;:MEASUREMENT:METHOD HISTOGRAM;REFLEVEL:METHOD PERCENT;ABSOLUTE:HIGH 0.0E+0;LOW 0.0E+0;MID 0.0E+0;MID2 0.0E+0;:MEASUREMENT:REFLEVEL:PERCENT:HIGH 90.0E+0;LOW 10.0E+0;MID 50.0E+0;MID2 50.0E+0

MEASUrement:CLEARSNapshot

Removes the measurement snapshot display.

Group Measurement

Syntax MEASUrement:CLEARSNapshot



Examples MEASUREMENT:CLEARSNAPSHOT

MEASUREMENT:GATING

Sets or queries measurement gating.

Group Measurement

Related Commands CURSOR:VBARS

Syntax MEASUREMENT:GATING { ON | OFF | <NR1> }
MEASUREMENT:GATING?

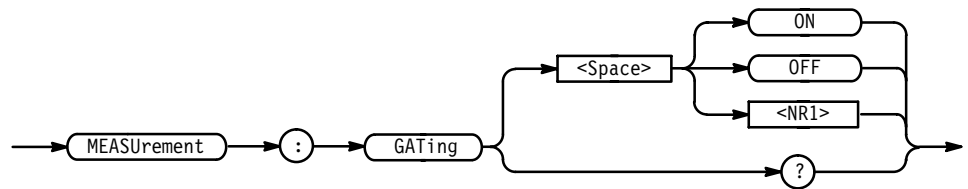

Arguments ON (or 1) turns on measurement gating.
OFF (or 0) turns off measurement gating.

Examples MEASUREMENT:GATING ON
MEASUREMENT:GATING?
might return MEASUREMENT:GATING 1
showing gating is turned on.
It might also return MEASUREMENT:GATING 0
showing gating is turned off.

MEASUREMENT:IMMED? (Query Only)

Returns all immediate measurement setup parameters.

Group Measurement

Syntax MEASUrement:IMMed?

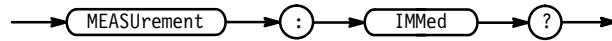

Examples MEASUREMENT:IMMED?
 might return :MEASUREMENT:IMMED:TYPE PERIOD;UNITS "s";SOURCE1 CH1;SOURCE2 CH1;DELAY:EDGE1 RISE;EDGE2 RISE; DIRECTION FORWARDS

MEASUrement:IMMed:DELAy? (Query Only)

Returns information about the immediate delay measurement.

Group Measurement

Syntax MEASUrement:IMMed:DELAy?

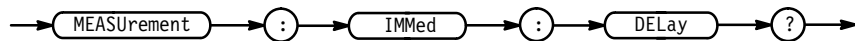

Examples MEASUREMENT:IMMED:DELAY?
 might return :MEASUREMENT:IMMED:DELAY:EDGE1 RISE;EDGE2 RISE; DIRECTION FORWARDS

MEASUrement:IMMed:DELAy:DIREction

Sets or queries the starting point and direction that determines the delay “to” edge when taking an immediate delay measurement. Use the MEASUrement:IMMed:SOURCE2 command to specify the delay “to” waveform.

Group Measurement

Syntax MEASUrement:IMMed:DELAy:DIREction {BACKWards | FORWards}
 MEASUrement:IMMed:DELAy:DIREction?

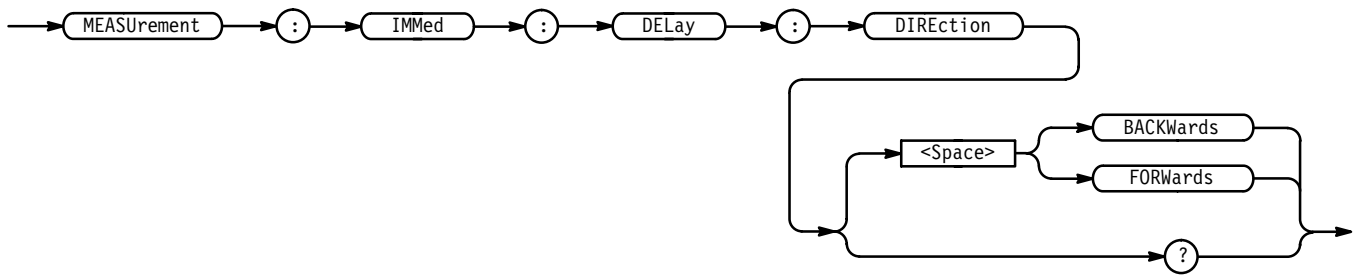

Arguments BACKWards means that the search starts at the end of the waveform and looks for the last rising or falling edge in the waveform. The slope of the edge is specified by MEASUrement:IMMed:DELay:EDGE2.

FORWards means that the search starts at the beginning of the waveform and looks for the first rising or falling edge in the waveform. The slope of the edge is specified by MEASUrement:IMMed:DELay:EDGE2.

Examples MEASUREMENT:IMMED:DELAY:DIRECTION FORWARDS
starts searching from the beginning of the waveform record.

MEASUREMENT:IMMED:DELAY:DIRECTION?
returns either BACKWARDS or FORWARDS.

MEASUrement:IMMed:DELay:EDGE1

Sets or queries the slope of the edge that is used for the delay “from” waveform when taking an immediate delay measurement. The waveform is specified by MEASUrement:IMMed:SOURCE1.

Group Measurement

Related Commands MEASUrement:IMMed:SOURCE1

Syntax MEASUrement:IMMed:DELay:EDGE1 { FALL | RISe }
MEASUrement:IMMed:DELay:EDGE1?

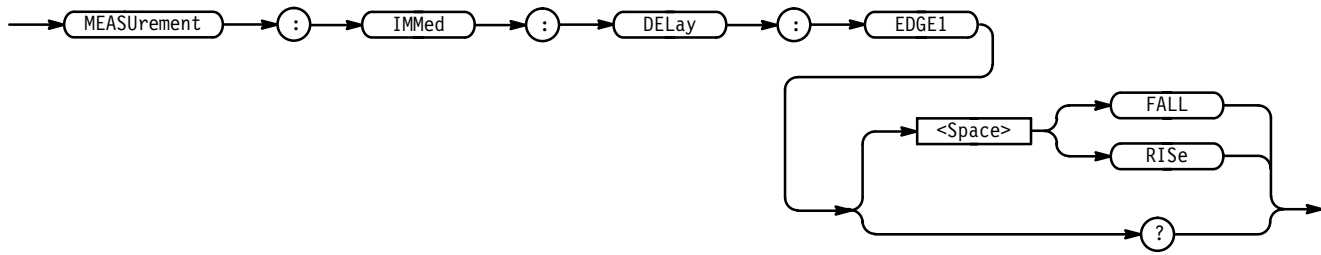

Arguments FALL specifies the falling edge.
RISe specifies the rising edge.

Examples MEASUREMENT:IMMED:DELAY:EDGE1 RISe
specifies that the rising edge be used for the immediate delay measurement.
MEASUREMENT:IMMED:DELAY:EDGE1?
returns either RISe or FALL.

MEASUREMENT:IMMED:DELAY:EDGE2

Sets or queries the slope of the edge that is used for the delay “to” waveform when taking an immediate delay measurement. The waveform is specified by MEASUREMENT:IMMED:SOURCE2.

Group Measurement

Related Commands MEASUREMENT:IMMED:SOURCE2

Syntax MEASUREMENT:IMMED:DELAY:EDGE2 { FALL | RISe }
MEASUREMENT:IMMED:DELAY:EDGE2?

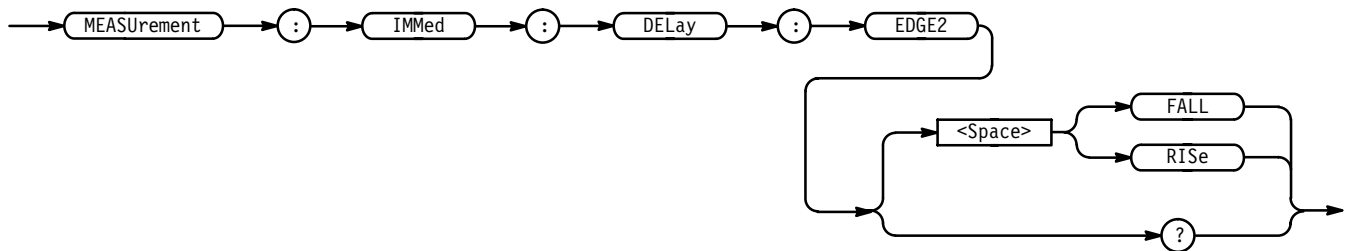

Arguments FALL specifies the falling edge.

RISe specifies the rising edge.

Examples MEASUREMENT:IMMED:DELAY:EDGE2 RISE
specifies that the rising edge be used for the immediate delay measurement.

MEASUREMENT:IMMED:DELAY:EDGE2?
returns FALL showing that the falling or negative edge of the waveform is used for the immediate delay measurement.

MEASUREMENT:IMMED:SOURCE[1]

Sets or queries the source for all single channel immediate measurements and specifies the source to measure “from” when taking an immediate delay measurement or phase measurement.

Group Measurement

Syntax MEASUREMENT:IMMED:SOURCE[1] { CH<x> | MATH<x> | REF<x> }
MEASUREMENT:IMMED:SOURCE[1]?

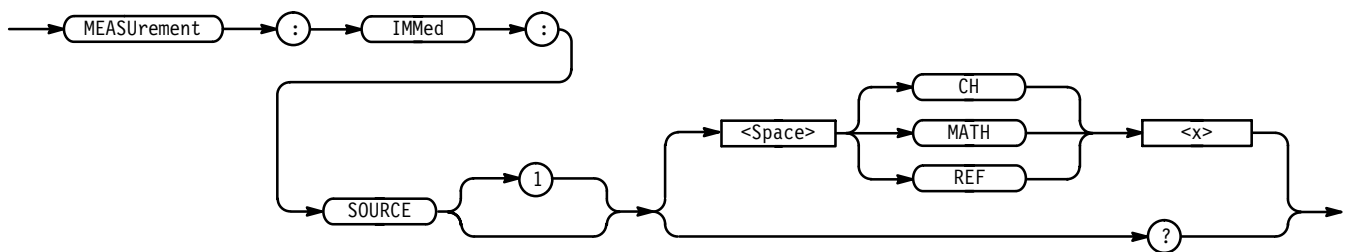

Arguments CH<x> is an input channel.
MATH<x> is a math waveform.
REF<x> is a reference waveform.

Examples MEASUREMENT:IMMED:SOURCE MATH1
specifies MATH1 as the immediate measurement source.

MEASUREMENT:IMMED:SOURCE2

Specifies the source to measure “to” when taking an immediate delay measurement or phase measurement.

Group Measurement

Syntax MEASUREMENT:IMMED:SOURCE2 { CH<x> | MATH<x> | REF<x> }
 MEASUREMENT:IMMED:SOURCE2?

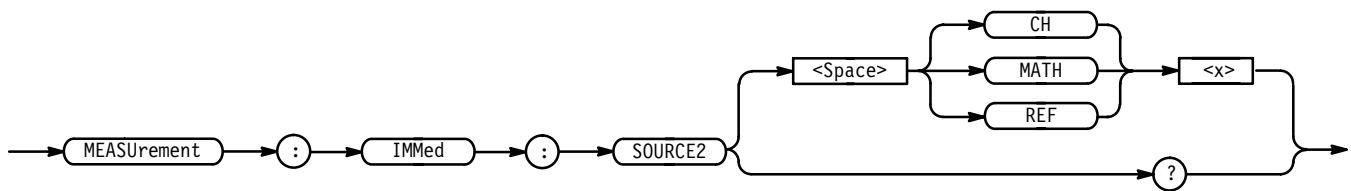

Arguments CH<x> is an input channel.
 MATH<x> is a math waveform.
 REF<x> is a reference waveform.

Examples MEASUREMENT:IMMED:SOURCE2 REF3
 sets the waveform in reference memory location 3 as the delay “to” source when making delay measurements.
 MEASUREMENT:IMMED:SOURCE2?
 might return MATH1.

MEASUREMENT:IMMED:TYPE

Specifies the immediate measurement.

Group Measurement

Syntax MEASUREMENT:IMMED:TYPE { AMPLitude | AREa | BURst | CAREa | CMEan | CRMs | DELay | FALL | FREQuency | HIGH | LOW | MAXimum | MEAN | MINimum | NDuty | NOVershoot | NWidth | PDUty | PERIOD | PHase | PK2pk | POVershoot | PWidth | RISE | RMS }
 MEASUREMENT:IMMED:TYPE?

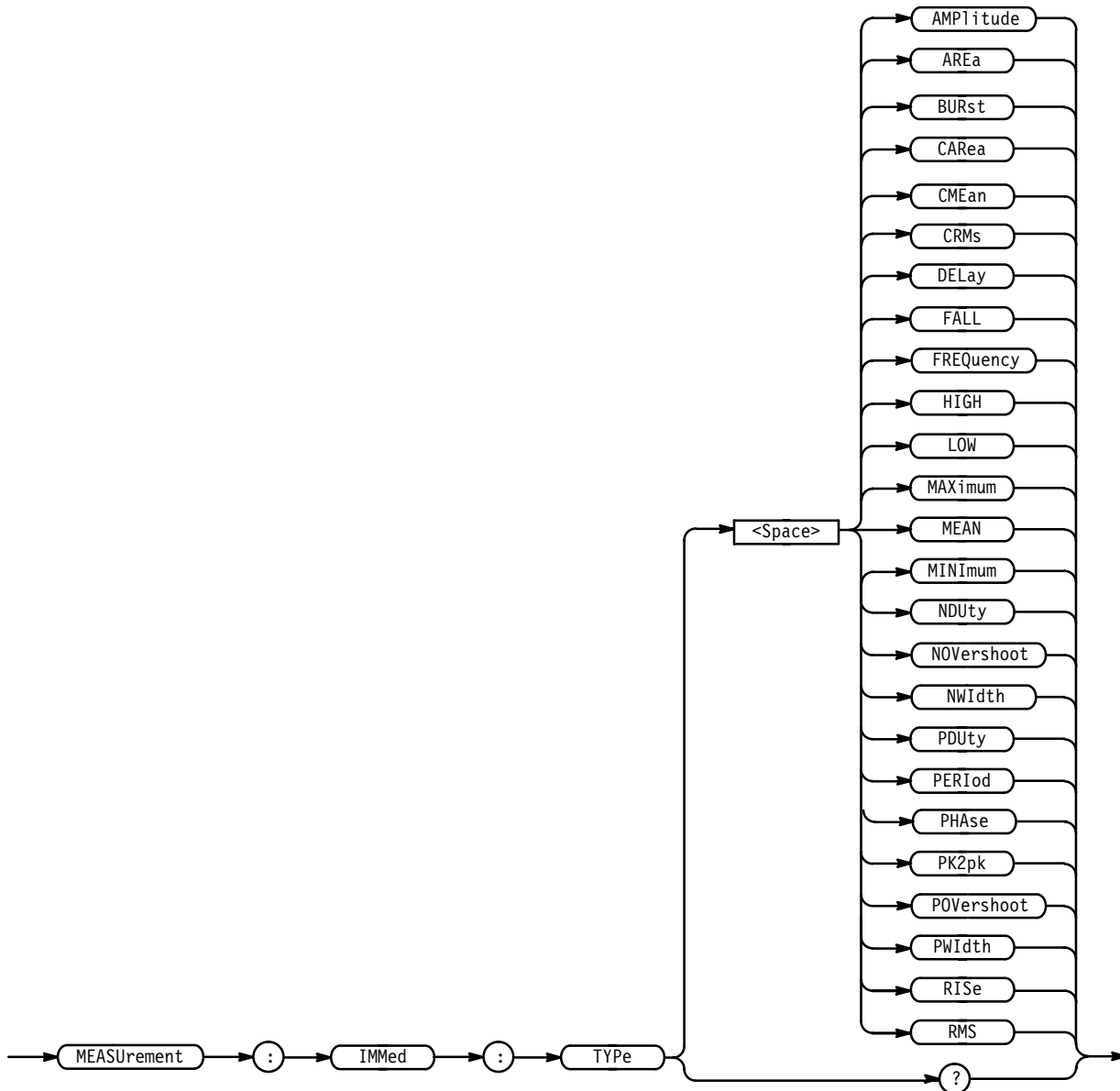

Arguments

AMPli tude is the high value minus the low value.

AREa is the area between the curve and ground over the entire waveform.

BURst is the time from the first MidRef crossing to the last MidRef crossing.

CAREa (cycle area) is the area between the curve and ground over one cycle.

CMEan is the arithmetic mean over one cycle.

CRMs is the true Root Mean Square voltage over one cycle.

DELay is the time between the MidRef crossings of two different waveforms.

FALL is the time that it takes for the falling edge of a pulse to fall from a HighRef value to a LowRef value of its final value.

FREQUENCY is the reciprocal of the period measured in hertz.

HIGH is the 100% reference level.

LOW is the 0% reference level.

MAXimum is the highest amplitude (voltage).

MEAN is the arithmetic mean over the entire waveform.

MINimum is the lowest amplitude (voltage).

NDUTY is the ratio of the negative pulse width to the signal period expressed as a percentage.

NOVershoot is the negative overshoot, expressed as:

$$NOVershoot = 100 \times \left(\frac{(Low - Minimum)}{Amplitude} \right)$$

NWIDth is the distance (time) between MidRef (usually 50%) amplitude points of a negative pulse.

PDUTY is the ratio of the positive pulse width to the signal period expressed as a percentage.

PERIOD is the time, in seconds, it takes for one complete signal cycle to happen.

PHASE is the phase difference from the selected waveform to the designated waveform.

PK2pk is the absolute difference between the maximum and minimum amplitude.

POVershoot is the positive overshoot, expressed as:

$$POVershoot = 100 \times \left(\frac{(Maximum - High)}{Amplitude} \right)$$

PWIDth is the distance (time) between MidRef (usually 50%) amplitude points of a positive pulse.

RISe is the time that it takes for the leading edge of a pulse to rise from a low reference value to a high reference value of its final value.

RMS is the true Root Mean Square voltage.

Examples MEASUREMENT:IMMED:TYPE FREQUENCY
defines the immediate measurement to be a frequency measurement.

MEASUREMENT:IMMED:UNITS? (Query Only)

Returns the units for the immediate measurement.

Group Measurement

Related Commands MEASUREMENT:IMMED:TYPE

Syntax MEASUREMENT:IMMED:UNITS?

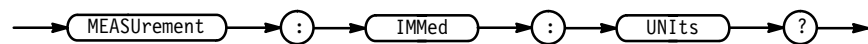

Returns <QString> returns "V" for volts, "s" for seconds, "Hz" for hertz, "VV" for volts², or "%" for percent.

On the TDS 4XXA, <QString> also returns "c" for clocks, "Vc" for volt-clocks, or "/c" for 1/clks.

Examples MEASUREMENT:IMMED:UNITS?
might return "s", indicating that the units for the immediate measurement are seconds.

MEASUREMENT:IMMED:VALUE? (Query Only)

Immediately executes the immediate measurement specified by the MEASUREMENT:IMMED:TYPE command. The measurement is taken on the source(s) specified by a MEASUREMENT:IMMED:SOURCE command.

Group Measurement

Syntax MEASUREMENT:IMMED:VALUE?

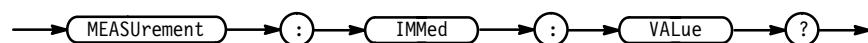

Returns <NR3>

MEASUrement:MEAS<x>? (Query Only)

Returns all measurement parameters for the displayed measurement specified by <x>.

Group Measurement

Syntax MEASUrement:MEAS<x>?

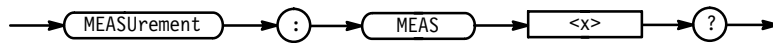

Examples MEASUREMENT:MEAS3?
 might return :MEASUREMENT:MEAS3:STATE 0;TYPE PERIOD;
 UNITS "s";SOURCE1 CH1;SOURCE2 CH2;DELAY:EDGE1 RISE;
 EDGE2 RISE;DIRECTION FORWARDS.

MEASUrement:MEAS<x>:DELay? (Query Only)

Returns the delay measurement parameters for the measurement specified by <x>.

Group Measurement

Syntax MEASUrement:MEAS<x>:DELay?

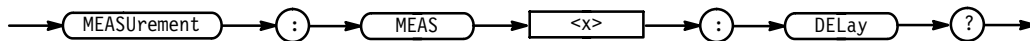

Examples MEASUREMENT:MEAS3:DELAY?
 might return :MEASUREMENT:MEAS3:DELAY:EDGE1 RISE;
 EDGE2 RISE;DIRECTION FORWARDS.

MEASUrement:MEAS<x>:DELay:DIREction

Sets or queries the starting point and direction that determines the delay “to” edge when taking a delay measurement. The waveform is specified by

MEASUrement:MEAS<X>:SOURCEx2. This command is equivalent to setting the direction in the Delay Edges & Direction side menu.

Group Measurement

Syntax MEASUrement:MEAS<x>:DELay:DIREction { BACKWards | FORWards }
MEASUrement:MEAS<x>:DELay:DIREction?

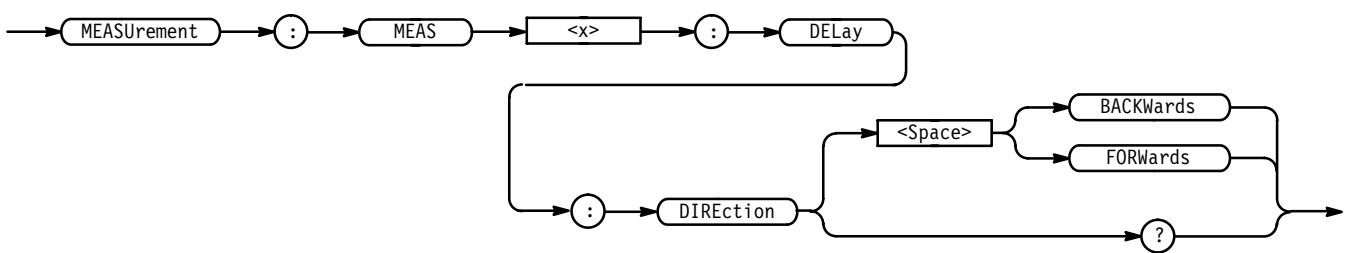

Arguments BACKWards means that the search starts at the end of the waveform and looks for the last rising or falling edge in the waveform. The slope of the edge is specified by MEASUrement:MEAS<x>:DELay:EDGE2.

FORWards means that the search starts at the beginning of the waveform and looks for the first rising or falling edge in the waveform. The slope of the edge is specified by MEASUrement:MEAS<x>:DELay:EDGE2.

Examples MEASUREMENT:MEAS1:DELAY:DIRECTION BACKWARDS
starts searching from the end of the waveform record.

MEASUREMENT:MEAS3:DELAY:DIRECTION?
might return FORWARDS for the search direction.

MEASUrement:MEAS<x>:DELay:EDGE1

Sets or queries the slope of the edge that is used for the delay “from” waveform when taking a delay measurement. The waveform is specified by MEASUrement:MEAS<x>:SOURCEx1. This command is equivalent to selecting the edges in the Delay Edges & Direction side menu.

Group Measurement

Syntax MEASUrement:MEAS<x>:DELay:EDGE1 { FALL | RISE }

MEASUrement:MEAS<x>:DELay:EDGE1?

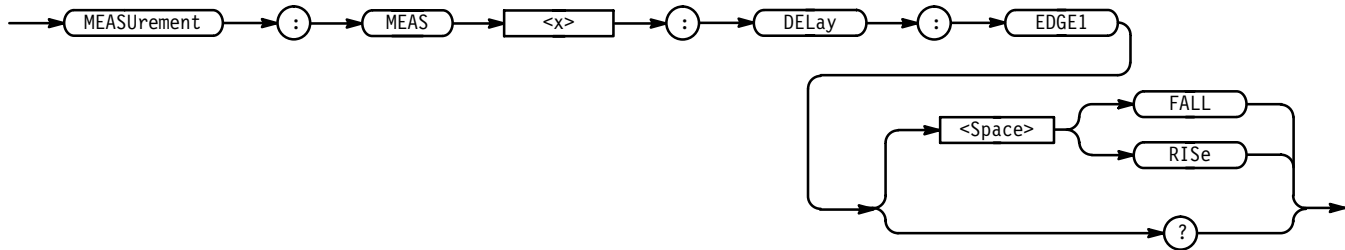

Arguments FALL specifies the falling edge.
RISe specifies the rising edge.

Examples MEASUREMENT:MEAS3:DELAY:EDGE1 RISe
specifies that the rising edge be used for measurement 3.
MEASUREMENT:MEAS1:DELAY:EDGE1?
returns either RISe or FALL for measurement 1.

MEASUrement:MEAS<x>:DELay:EDGE2

Sets or queries the slope of the edge that is used for the delay “to” waveform when taking a delay measurement. The waveform is specified by MEASUrement:MEAS<x>:SOURCE2. This command is equivalent to selecting the edges in the Delay Edges & Direction side menu.

Group Measurement

Syntax MEASUrement:MEAS<x>:DELay:EDGE2 { FALL | RISe }
MEASUrement:MEAS<x>:DELay:EDGE2?

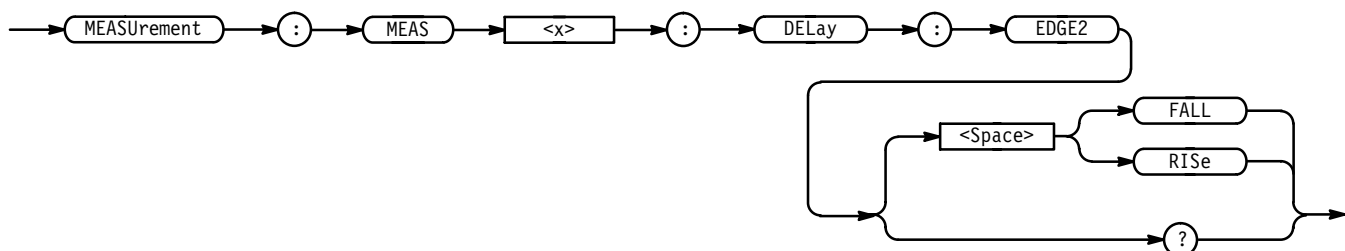

Arguments FALL specifies the falling edge.

RISe specifies the rising edge.

Examples MEASUREMENT:MEAS2:DELAY:EDGE2 RISE
specifies that the rising edge be used for the second delay measurement.

MEASUREMENT:MEAS2:DELAY:EDGE2?
might return FALL showing that the falling or negative edge of the waveform is used for the second measurement.

MEASUREMENT:MEAS<x>:SOURCE[1]

Sets or queries the source for all single channel measurements and specifies the source to measure “from” when taking a delay measurement or phase measurement.

Group Measurement

Syntax MEASUREMENT:MEAS<x>:SOURCE[1] { CH<x> | MATH<x> | REF<x> }
MEASUREMENT:MEAS<x>:SOURCE[1]?

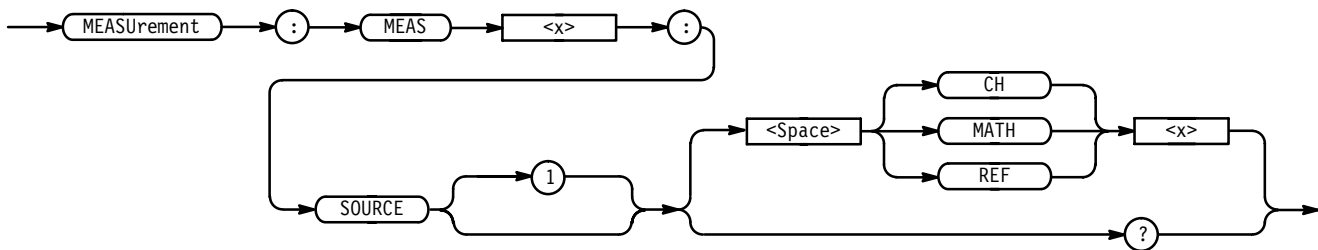

Arguments CH<x> is an input channel.
MATH<x> is a math waveform.
REF<x> is a reference waveform.

Examples MEASUREMENT:MEAS2:SOURCE1 MATH1
specifies MATH1 as the measurement 2 source.

MEASUrement:MEAS<x>:SOURCE2

Sets or queries the source to measure “to” when taking a delay measurement or phase measurement. This is equivalent to setting the source in the Delay from Selected Wfm side menu or the Phase from Selected Wfm side menu.

Group Measurement

Syntax MEASUrement:MEAS<x>:SOURCE2 { CH<x> | MATH<x> | REF<x> }
 MEASUrement:MEAS<x>:SOURCE2?

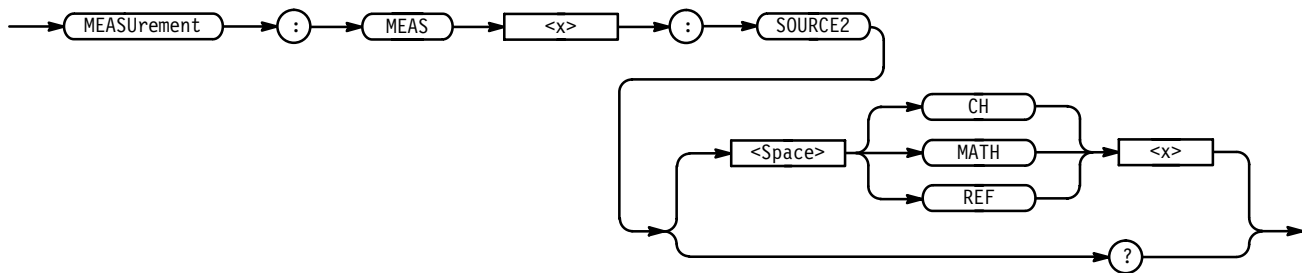

Arguments CH<x> is an input channel.
 MATH<x> is a math waveform.
 REF<x> is a reference waveform.

Examples MEASUREMENT:MEAS4:SOURCE2 CH<x>
 sets channel 1 as the delay “to” source when making delay measurements.
 MEASUREMENT:MEAS2:SOURCE2?
 might return MATH1.

MEASUrement:MEAS<x>:STATE

Controls the measurement system. The source specified by MEASUrement:MEAS<x>:SOURCE1 must be selected for the measurement to be displayed. The source can be selected using the SELEct:CH<x> command.

Group Measurement

Syntax MEASUrement:MEAS<x>:STATE { OFF | ON | <NR1> }
 MEASUrement:MEAS<x>:STATE?

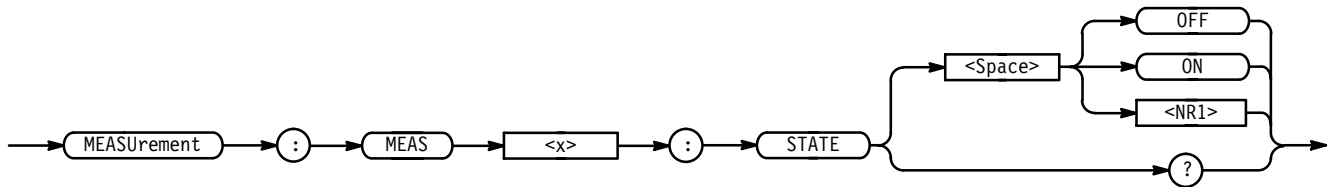

Arguments OFF or <NR1> = 0 turns measurements off. You can also turn the state off by deselecting the source.

ON or <NR1> ≠ 0 turns measurements on.

Examples MEASUREMENT:MEAS1:STATE ON
 turns measurement defined as MEAS1 on.

MEASUREMENT:MEAS4:STATE?
 returns either 0 or 1, indicating the state of MEAS4.

MEASUrement:MEAS<x>:TYPE

Sets or queries the measurement type for the measurement specified by MEAS<x>. This is equivalent to selecting the measurement in the Select Measurement side menu.

Group Measurement

Syntax MEASUrement:MEAS<x>:TYPE { AMPLitude | AREa | BURst | CAREa |
 CMEan | CRMs | DELay | FALL | FREQuency | HIGH | LOW | MAXimum |
 MEAN | MINimum | NDuty | NOVershoot | NWidth | PDuty | PERIOD
 | PHase | PK2pk | POVershoot | PWidth | RISE | RMS }
 MEASUrement:MEAS<x>:TYPE?

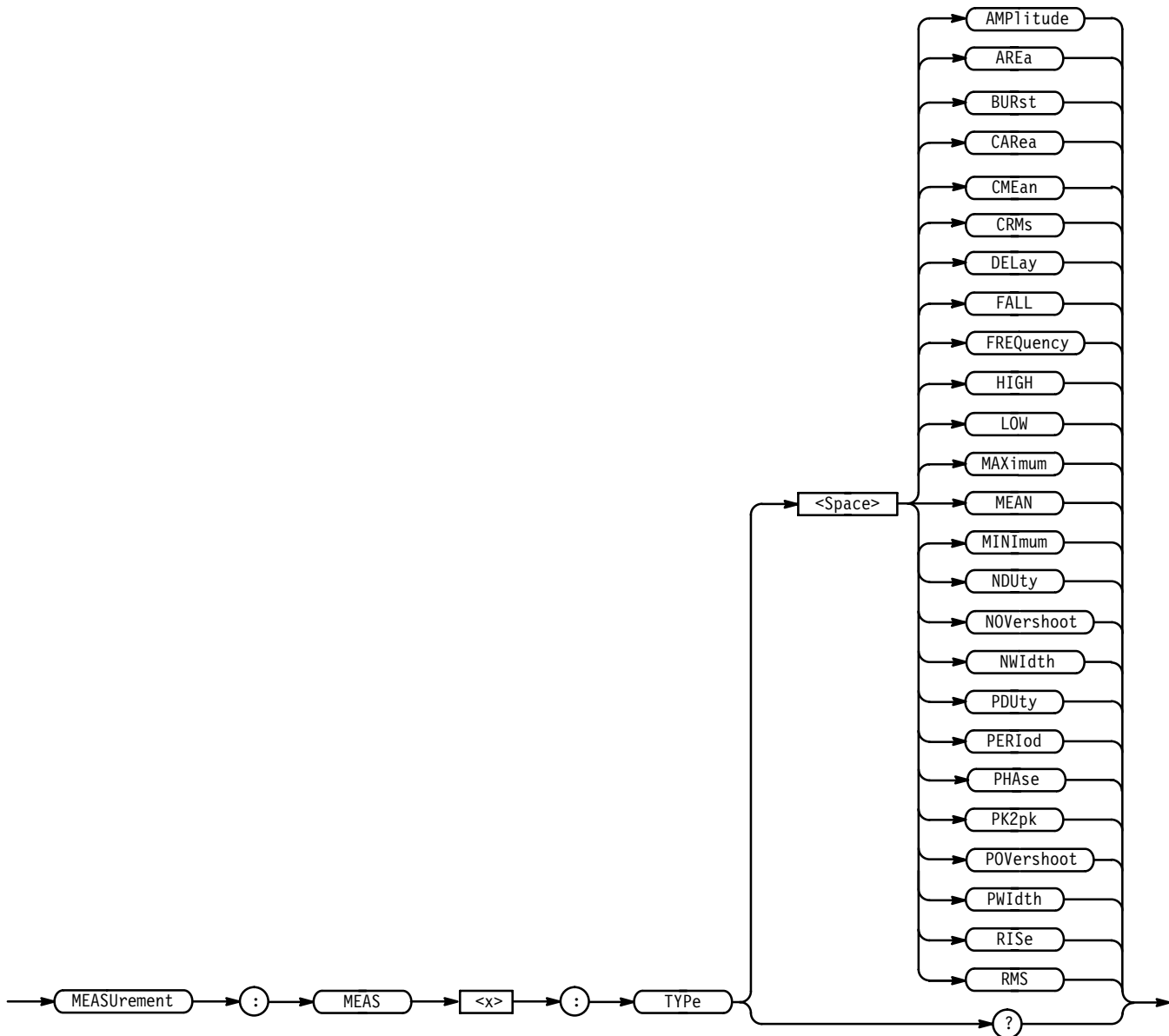

Arguments

AMPli tude is the high value minus the low value or HIGH – LOW.

AREa is the area between the curve and ground over the entire waveform.

BURst is the time from the first MidRef crossing to the last MidRef crossing.

CAREa (cycle area) is the area between the curve and ground over one cycle.

CMEan is the arithmetic mean over one cycle.

CRMs is the true Root Mean Square voltage over one cycle.

DELay is the time between the MidRef crossings of two different waveforms.

FALL is the time that it takes for the falling edge of a pulse to fall from a HighRef value to a LowRef value of its final value.

FREQUENCY is the reciprocal of the period measured in hertz.

HIGH is the 100% reference level.

LOW is the 0% reference level.

MAXimum is the highest amplitude (voltage).

MEAN is the arithmetic mean over the entire waveform.

MINimum is the lowest amplitude (voltage).

NDuty is the ratio of the negative pulse width to the signal period expressed as a percentage.

NOvershoot is the negative overshoot, expressed as:

$$NOvershoot = 100 \times \left(\frac{(Low - Minimum)}{Amplitude} \right)$$

NWidth is the distance (time) between MidRef (usually 50%) amplitude points of a negative pulse.

PDuty is the ratio of the positive pulse width to the signal period expressed as a percentage.

PERIOD is the time, in seconds, it takes for one complete signal cycle to happen.

PHASE is the phase difference from the selected waveform to the designated waveform.

PK2pk is the absolute difference between the maximum and minimum amplitude.

POvershoot is the positive overshoot, expressed as:

$$POvershoot = 100 \times \left(\frac{(Maximum - High)}{Amplitude} \right)$$

PWidth is the distance (time) between MidRef (usually 50%) amplitude points of a positive pulse.

RISE is the time that it takes for the leading edge of a pulse to rise from a low reference value to a high reference value of its final value.

RMS is the true Root Mean Square voltage.

Examples MEASUREMENT:MEAS3:TYPE RMS
specifies MEAS3 to calculate the Root Mean Square voltage.

MEASUREMENT:MEAS<x>:UNITS? (Query Only)

Returns the units for the measurement specified by MEASUREMENT:MEAS<x>:TYPE.

Group Measurement

Syntax MEASUREMENT:MEAS<x>:UNITS?

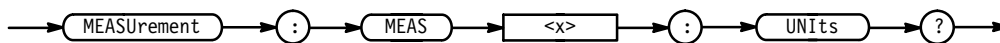

Returns <QString> returns "V" for volts, "s" for seconds, "HZ" for hertz, "VV" for volts², or "%" for percent.

On the TDS 4XXA, <QString> also returns "c" for clocks, "Vc" for volt-clocks, or "/c" for 1/clks.

Examples MEASUREMENT:MEAS3:UNITS?
might return "%", indicating the units for Measurement 3 are percent.

MEASUREMENT:MEAS<x>:VALUE? (Query Only)

Returns the value that has been calculated for the measurement specified by <x>.

NOTE. This value is a display value and will be updated perhaps every 1/3 second. If you are acquiring a long acquisition record, the TDS may take longer than this time to update.

Group Measurement

Syntax MEASUREMENT:MEAS<x>:VALUE?

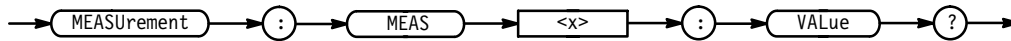

Returns <NR3>

MEASUREMENT:METHOD

Sets or queries the method used to calculate the 0% and 100% reference level. This is equivalent to setting the **High-Low Setup** in the Measure menu.

Group Measurement

Syntax MEASUREMENT:METHOD { HISTogram | MINMax }
MEASUREMENT:METHOD?

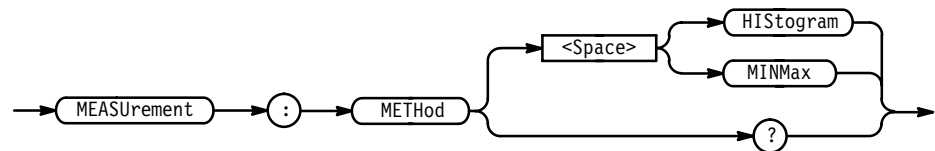

Arguments HISTogram sets the high and low waveform levels statistically using a histogram algorithm.

MINMax sets the high and low waveform levels to MAX and MIN, respectively.

Examples MEASUREMENT:METHOD HISTOGRAM
specifies that the high and low reference levels are set statistically.

MEASUREMENT:METHOD?
returns MINMAX when the reference levels are set to MIN and MAX.

MEASUREMENT:REFLevel? (Query Only)

Returns the reference levels.

Group Measurement

Syntax MEASUREMENT:REFLevel?

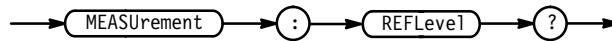

MEASUrement:REFLevel:ABSolute:HIGH

Sets or queries the high reference level, and is the 100% reference level when MEASUrement:REFLevel:METHOD is set to ABSolute. This command is equivalent to setting the **Reference Levels** in the Measure menu.

Group Measurement

Syntax MEASUrement:REFLevel:ABSolute:HIGH <NR3>
 MEASUrement:REFLevel:ABSolute:HIGH?

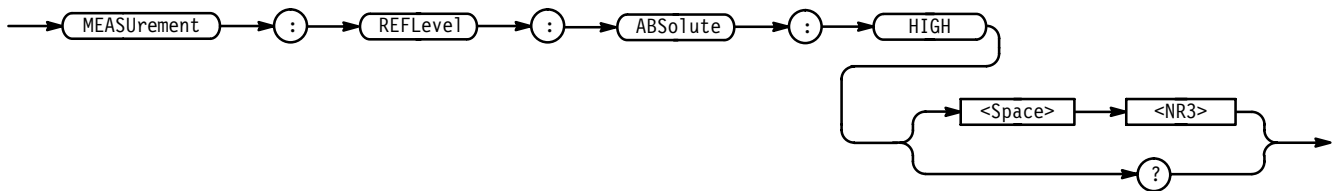

Arguments <NR3> is the high reference level, in volts. The default is 0.0 V.

Examples MEASUREMENT:REFLEVEL:ABSOLUTE:HIGH 1.71
 sets the high reference level to 1.71 V.

MEASUrement:REFLevel:ABSolute:LOW

Sets or queries the low reference level, and is the 0% reference level when MEASUrement:REFLevel:METHOD is set to ABSolute. This command is equivalent to setting the **Reference Levels** in the Measure menu.

Group Measurement

Syntax MEASUrement:REFLevel:ABSolute:LOW <NR3>
 MEASUrement:REFLevel:ABSolute:LOW?

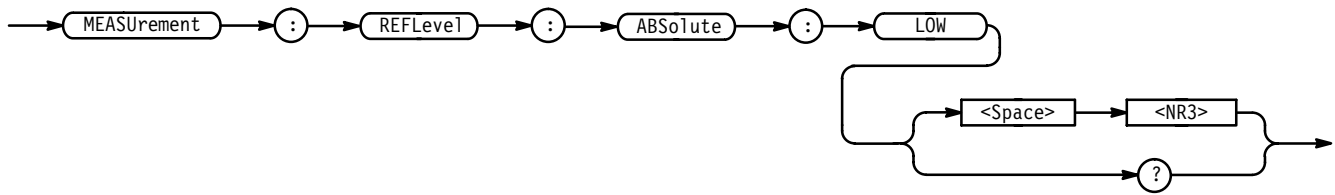

Arguments <NR3> is the low reference level, in volts. The default is 0.0 V.

Examples MEASUREMENT:REFLEVEL:ABSOLUTE:LOW?
might return 0.0E+0 as the low reference level.

MEASUREMENT:REFLEVEL:ABSOLUTE:MID

Sets or queries the mid reference level, and is the 50% reference level when MEASUREMENT:REFLEVEL:METHOD is set to ABSOLUTE. This command is equivalent to setting the **Reference Levels** in the Measure menu.

Group Measurement

Syntax MEASUREMENT:REFLEVEL:ABSOLUTE:MID <NR3>
MEASUREMENT:REFLEVEL:ABSOLUTE:MID?

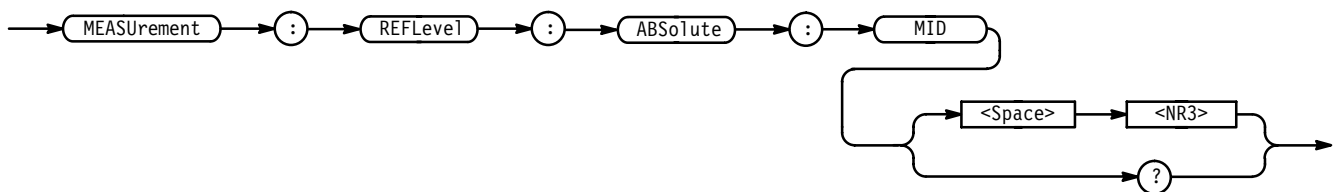

Arguments <NR3> is the mid reference level, in volts. The default is 0.0 V.

Examples MEASUREMENT:REFLEVEL:ABSOLUTE:MID .71
sets the mid reference level to .71 volts.

MEASUREMENT:REFLEVEL:ABSOLUTE:MID2

Sets or queries the mid reference level for the “to” waveform when taking a delay measurement, and is the 50% reference level when MEASUREMENT:REFLEVEL:METHOD is set to ABSOLUTE. This command is equivalent to setting the **Reference Levels** in the Measure menu.

Group Measurement

Syntax MEASUREMENT:REFLEVEL:ABSOLUTE:MID2 <NR3>
 MEASUREMENT:REFLEVEL:ABSOLUTE:MID2?

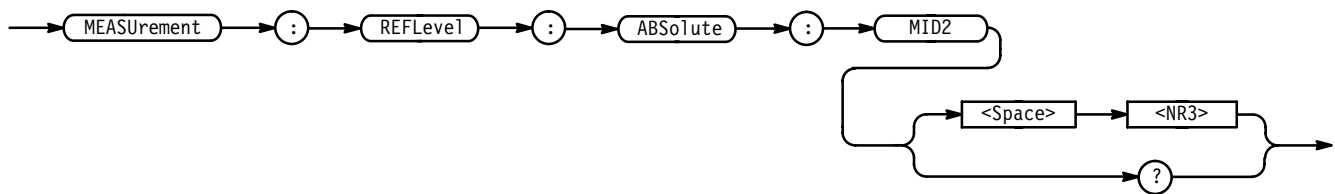

Arguments <NR3> is the mid reference level, in volts. The default is 0.0 V.

Examples MEASUREMENT:REFLEVEL:ABSOLUTE:MID2 0.5
 sets the mid reference level for the delay waveform to 0.5 volts.

MEASUREMENT:REFLEVEL:METHOD

Specifies which reference levels are used for measurement calculations. This command is equivalent to setting the levels in the Reference Levels side menu.

Group Measurement

Syntax MEASUREMENT:REFLEVEL:METHOD { ABSOLUTE | PERCENT }
 MEASUREMENT:REFLEVEL:METHOD?

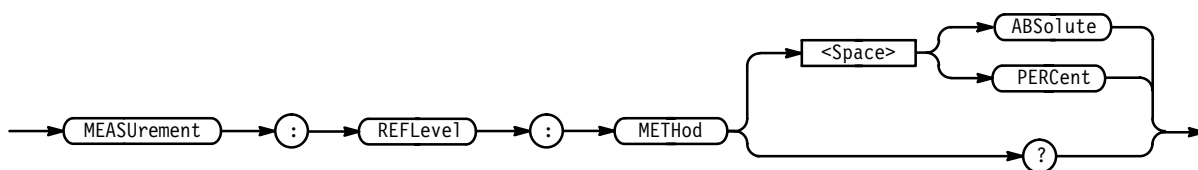

Arguments ABSolute specifies that the reference levels are set explicitly using the MEASUREMENT:REFLevel:ABSolute commands. This method is useful when precise values are required. For instance, when designing to published interface specifications such as RS-232-C.

PERCent specifies that the reference levels are calculated as a percent relative to HIGH and LOW. The percentages are defined using the MEASUREMENT:REFLevel:PERCent commands.

Examples MEASUREMENT:REFLEVEL:METHOd ABSolute
specifies that explicit user-defined values are used for the reference levels.

MEASUREMENT:REFLEVEL:METHOd?
returns either ABSolute or PERCENT, indicating the reference levels used.

MEASUREMENT:REFLevel:PERCent:HIGH

Sets or queries the percent, where 100% is equal to HIGH, that is used to calculate the high reference level when MEASUREMENT:REFLevel:METHOd is set to PERCent. This command is equivalent to setting the **Reference Levels** in the Measure menu.

Group Measurement

Syntax MEASUREMENT:REFLevel:PERCent:HIGH <NR3>
MEASUREMENT:REFLevel:PERCent:HIGH?

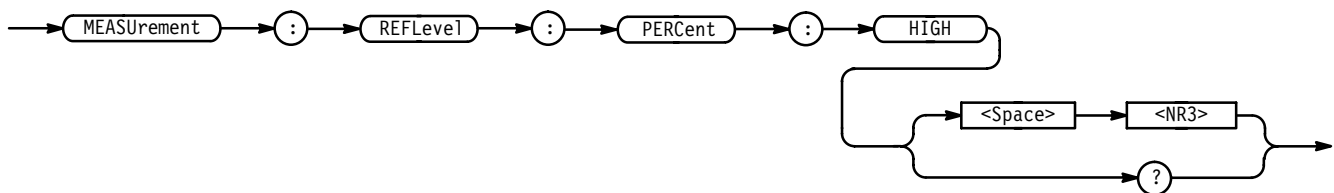

Arguments <NR3> ranges from 0 to 100 percent, and is the high reference level. The default is 90%.

Examples MEASUREMENT:REFLEVEL:PERCENT:HIGH 95
specifies that the high reference level is set to 95% of HIGH.

MEASUrement:REFLevel:PERCent:LOW

Sets or queries the percent, where 100% is equal to HIGH, that is used to calculate the low reference level when MEASUrement:REFLevel:METHOD is set to PERCent. This command is equivalent to setting the **Reference Levels** in the Measure menu.

Group Measurement

Syntax MEASUrement:REFLevel:PERCent:LOW <NR3>
 MEASUrement:REFLevel:PERCent:LOW?

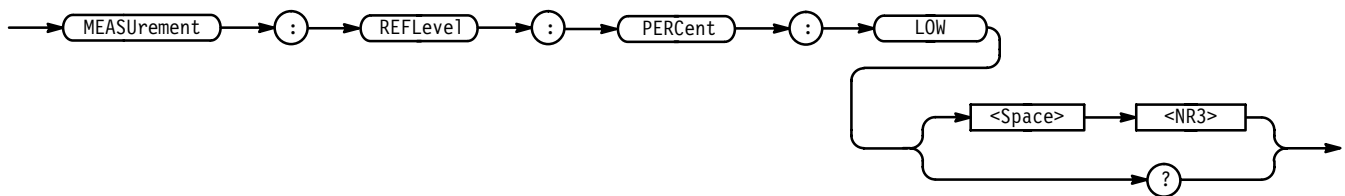

Arguments <NR3> ranges from 0 to 100 percent, and is the low reference level. The default is 10%.

Examples MEASUREMENT:REFLEVEL:PERCENT:LOW?
 might return 15, meaning that the low reference level is 15% of HIGH.

MEASUrement:REFLevel:PERCent:MID

Sets or queries the percent, where 100% is equal to HIGH, that is used to calculate the mid reference level when MEASUrement:REFLevel:METHOD is set to PERCent. This command is equivalent to setting the **Reference Levels** in the Measure menu.

Group Measurement

Syntax MEASUrement:REFLevel:PERCent:MID <NR3>
 MEASUrement:REFLevel:PERCent:MID?

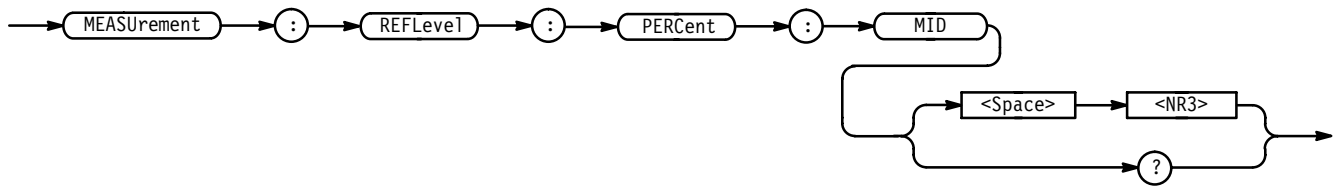

Arguments <NR3> ranges from 0 to 100 percent, and is the mid reference level. The default is 50%.

Examples MEASUREMENT:REFLEVEL:PERCENT:MID 60
specifies that the mid reference level is set to 60% of HIGH.

MEASUREMENT:REFLEVEL:PERCENT:MID2

Sets or queries the percent, where 100% is equal to HIGH, that is used to calculate the mid reference level for the second waveform specified when taking a delay measurement. This command is equivalent to setting the **Reference Levels** in the Measure menu.

Group Measurement

Syntax MEASUREMENT:REFLEVEL:PERCENT:MID2 <NR3>
MEASUREMENT:REFLEVEL:PERCENT:MID2?

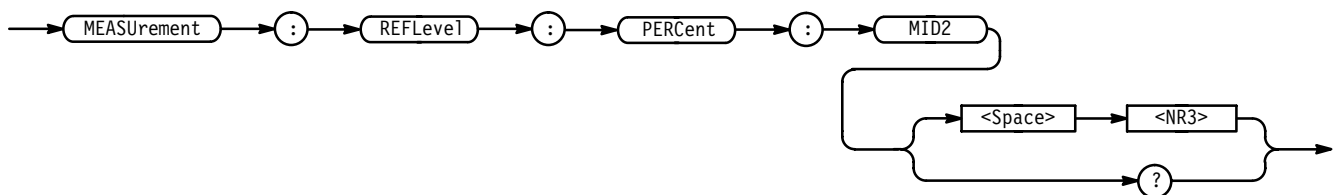

Arguments <NR3> ranges from 0 to 100 percent, and is the mid reference level. The default is 50%.

Examples MEASUREMENT:REFLEVEL:PERCENT:MID2 40
specifies that the mid reference level is set to 40% of HIGH.

MEASUrement:SNAPShot

Displays the measurement snapshot.

Group Measurement

Syntax MEASUrement:SNAPShot



Examples MEASUREMENT:SNAPSHOT

MESSage

Clears the message window and the MESSage? query returns the current message parameters.

Group Display

Syntax MESSage CLEar

MESSage?

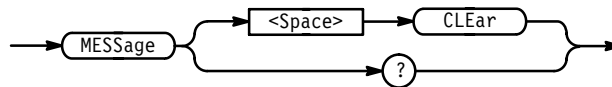

Arguments CLEar removes the message from the message window. This is equivalent to sending MESSage SHOW "".

Examples MESSAGE CLEAR
clears the message from the window.

MESSage:BOX

Defines the size and position of the message window. This command does not display the window unless MESSage:STATE is ON.

Group Display

Syntax MESSage:BOX <X1>,<Y1>,<X2>,<Y2>

MESSage:BOX?

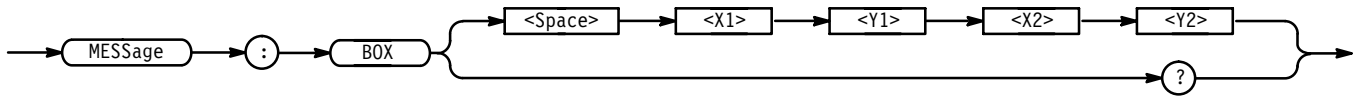

Arguments <X1> and <X2> = 0 to 640, and are pixel positions along the horizontal axis. <X1> defines the left and <X2> defines the right side of the window.

<Y1> and <Y2> = 0 to 480, and are pixel positions along the vertical axis. <Y1> defines the top and <Y2> defines the bottom of the window. The reserved height of all characters is 15 pixels so the window must be at least that high to fully display characters. For a complete list of character widths in pixels, see Table A-1 on page A-1. Shorter windows clip characters.

Figure 3-1 shows the coordinate system relative to the screen.

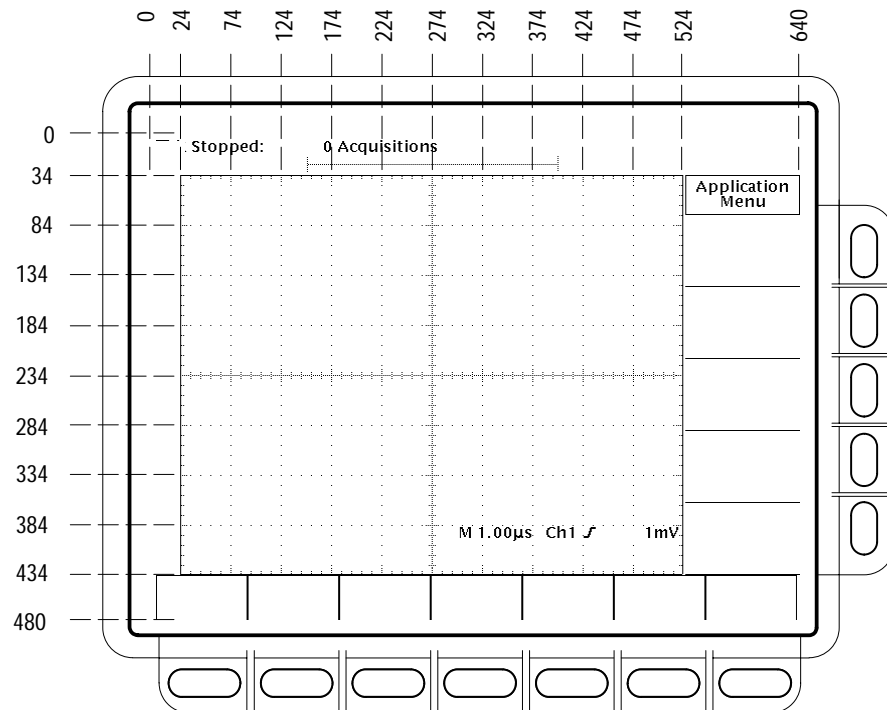

Figure 2-4: Message Window Coordinates

MESSage:SHOW

Clears the contents of the message window and displays the new message in the window.

Group Display

Syntax MESSage:SHOW <QString>
MESSage:SHOW?

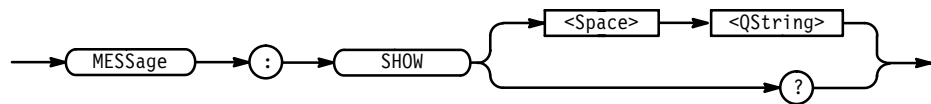

Arguments <QString> is the message and can include any of the characters shown in the TDS Character Chart in Appendix A. The maximum length of the message is 1000 characters.

The message is left-justified, and is displayed on a single line starting with the top most line in the window. A line feed character can be embedded in the string to position the message on multiple lines. You can also use white space and tab characters to position the message within a line.

You can send a tab by transmitting a tab character (decimal 9) followed by two characters representing the most significant eight bits followed by the least significant eight bits of a 16-bit number. The number specifies the pixel column relative to the left margin of the label area. For example, to tab to pixel 13, send TAB (decimal 9), NUL (decimal 0), and CR (decimal 13).

The ESC character followed by the @ character turns inverse video on or off and can be embedded in the message string. The first ESC character followed by a @ character displays all the text that follows in inverse video until another ESC character followed by a @ character is found in the string.

NOTE. The use of any escape codes other than what is described above may produce unpredictable results.

The label area is the height and width you have set using the MESSage:Box command. The length of the label that fits in the label area depends on the contents of the label because the width of characters varies. For a complete list of character widths in pixels, see Table A-1 on page A-1.

If the message exceeds the limits of the window, either horizontally or vertically, the portion of the message that exceeds the limits will not be displayed. The

message string itself is not altered. The entire message can be returned as a query response regardless of what is displayed in the window.

- Examples**
- MESSAGE:SHOW "Hello world"
displays "Hello world" in the upper left corner of the box (you can define the box size with the MESSAGE BOX command).
- MESSAGE:SHOW "Hello @world@ ... hello"
displays "Hello world ... hello" in the upper left corner of the box and the word "world" is displayed in inverse video. In this example, @ stands for the escape character. The escape character may appear differently for you depending on your GPIB talker-listener program.

MESSAge:STATE

Controls the display of the message window.

- Group** Display
- Syntax** MESSAge:STATE { OFF | ON | <NR1> }
MESSAge:STATE?

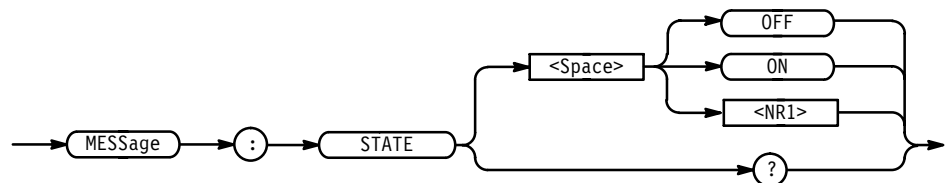

- Arguments**
- <OFF> or <NR1> = 0 removes the message window from the screen.
- <ON> or <NR1> ≠ 0 displays the message window and its contents on the screen. The size of the window is defined by MESSAge:BOX.

NEWpass (No Query Form)

Changes the password that enables access to password protected data. The PASSWord command must be successfully executed before using this command or an execution error will be generated.

- Group** Miscellaneous

Related Commands PASSWord, *PUD

Syntax NEWpass <QString>

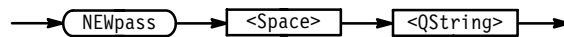

Arguments <QString> is the new password. The password can include up to 10 characters.

Examples NEWPASS "mypassword"
creates a new password for accessing the user protected data.

*OPC

Generates the operation complete message in the Standard Event Status Register (SESR) when all pending operations finish. The *OPC? query places the ASCII character "1" into the output queue when all pending operations are finished. The *OPC? response is not available to read until all pending operations finish. For a complete discussion of the use of these registers and the output queue, see page 3-1.

Group Status and Error

Related Commands BUSY?, *WAI

Syntax *OPC
*OPC?

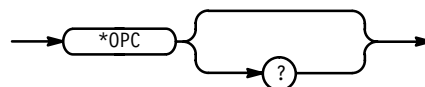

The *OPC command allows you to synchronize the operation of the digitizing oscilloscope with your application program. Synchronization methods are described starting on page 3-7.

Table 2-31: Commands that Generate an Operation Complete Message

Operation	Command
Automatic scope adjustment	AUTOSet EXECute
Internal self-calibration	*CAL
Single sequence acquisition	ACQUIRE:STATE ON or ACQUIRE:STATE RUN (when ACQUIRE:STOPAfter is set to SEQUENCE)
Hardcopy output	HARDCopy START

OPT? (Query Only)TDS 5XXA, 6XXA, & 7XXA Only*

Returns a list of options installed in your digitizing oscilloscope.

Group Status and Error**Syntax** *OPT?

Examples OPT?
 Might return: 13:Rs232/cent,1M:extended record length,
 2F:math pack,05:video trigger,0,CD:color display.

PASSWord (No Query Form)

Enables the *PUD and NEWpass set commands. Sending PASSWord without any arguments disables these same commands. Once the password is successfully entered, the *PUD and NEWpass commands are enabled until the digitizing oscilloscope is powered off, or until the FACTory command, the PASSWord command with no arguments, or the *RST command is issued.

To change the password, you must first enter the valid password with the PASSWord command and then change to your new password with the NEWpass command. Remember that the password is case sensitive.

Group Miscellaneous

Related Commands NEWpass, *PUD

Syntax PASSWord
 PASSWord <QString>

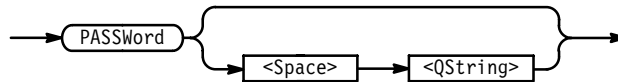

Arguments <QString> is the password and can include up to 10 characters. The factory default password is “XYZZY” and is always valid.

Examples PASSWORD "XYZZY"
 Enables the *PUB and NEWpass set commands.

PASSWORD
 Disables the *PUD and NEWpass set commands. You can still use the query version of *PUD.

*PSC

Sets and queries the power-on status flag that controls the automatic power-on handling of the DESER, SRER, and ESER registers. When *PSC is true, the DESER register is set to 255 and the SRER and ESER registers are set to 0 at power-on. When *PSC is false, the current values in the DESER, SRER, and ESER registers are preserved in nonvolatile memory when power is shut off and are restored at power-on. For a complete discussion of the use of these registers, see page 3–1.

Group Status and Error

Related Commands DESE, *ESE, FACtory, *RST, *SRE

Syntax *PSC <NR1>
 *PSC?

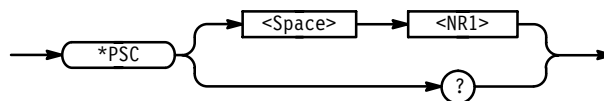

Arguments <NR1> = 0 sets the power-on status clear flag to false, disables the power-on clear and allows the digitizing oscilloscope to possibly assert SRQ after power-on.

<NR1> ≠ 0 sets the power-on status clear flag true. Sending *PSC 1 therefore enables the power-on status clear and prevents any SRQ assertion after power-on. Using an out-of-range value causes an execution warning.

Examples *PSC 0
sets the power-on status clear flag to false.

*PSC?
might return the value 1, showing that the power-on status clear flag is set to true.

*PUD

Sets or queries a string of Protected User Data. This data is protected by the PASSWord command. You can modify it only by first entering the correct password. The password is not necessary to query the data.

Group Miscellaneous

Related Commands PASSWord

Syntax *PUD <Block>
*PUD?

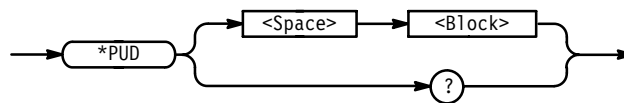

Arguments <Block> is a string containing up to 100 characters.

Examples *PUD #229This instrument belongs to me
stores the string “This instrument belongs to me” in the user protected data area.

*PUD?
might return #221Property of Company X.

*RCL (No Query Form)

Restores the state of the digitizing oscilloscope from a copy of its settings stored in memory. (The settings are stored using the *SAV command.) This command is equivalent to RECALL:SETUp and performs the same function as the **Recall Saved Setup** item in the front-panel Save/Recall Setup menu.

Group Save and Recall

Related Commands DELEte:SETUp, FACtory, *LRN?, RECALL:SETUp, *RST, *SAV, SAVe:SETUp

Syntax *RCL <NR1>

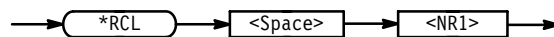

Arguments <NR1> is a value in the range from 1 to 10, and specifies a setup storage location. Using an out-of-range value causes an execution error (222, "Data out of range").

Examples *RCL 3
restores the digitizing oscilloscope from a copy of the settings stored in memory location 3.

RECALL:SETUp (No Query Form)

Restores a stored or factory front-panel setup of the digitizing oscilloscope. This command is equivalent to selecting **Recall Saved Setup** or **Recall Factory Setup** or **Recall Current Setup** in the Save/Recall Setup menu.

Group Save and Recall

Related Commands DELEte:SETUp, FACtory, *RCL, *RST, *SAV, SAVe:SETUp

Syntax RECALL:SETUp { FACtory | <NR1> | <file path> }

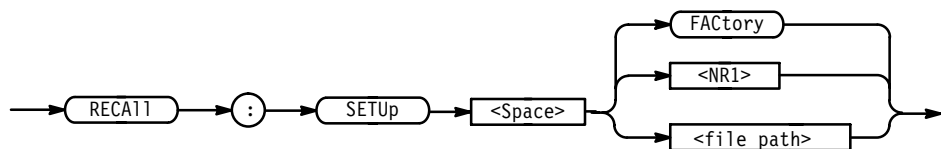

Arguments FACtory selects the factory setup.

<NR1> is a value in the range from 1 to 10 and specifies a setup storage location. Using an out-of-range value causes an execution error (222, "Data out of range").

<file path> (available on instruments with the Option 1F File System) is the location in mass storage memory where the setup will be recalled from.

<file path> is a quoted string that defines the file name and path. Input the file path using the form <drive>/<dir>/<filename>. <drive> and one or more <dir>s are optional. If you do not specify them, the TDS will read the file from the default directory. <filename> stands for a filename of up to 8 characters followed by a period (".") and any 3-character extension. Do not use wild card characters.

Examples RECALL:SETUP FACTORY
recalls (and makes current) the front panel setup to its factory defaults.

RECALL:SETUP 1
recalls the front panel setup from setup1.

RECALL:SETUP "TEK00000.SET"
recalls the front panel setup from the file TEK00000.SET in the default directory and on the default drive.

RECALL:WAVEform (No Query Form)

TDS 5XXA, 6XXA, & 7XXA Only

Recalls a stored waveform into a reference location. This command is equivalent to selecting **Recall File** in the Save/Recall Waveform menu.

Group Save and Recall

Syntax RECALL:WAVEform <file path>,REF<x>

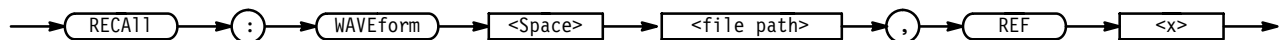

Arguments REF<x> is the location in internal reference memory where the waveform is recalled from.

<file path> is a quoted string that defines the file name and path. Input the file path using the form <drive>/<dir>/<filename>. <drive> and one or more <dir>s are optional. If you do not specify them, the TDS will recall the waveform from the default directory. <filename> stands for a filename of up to

8 characters followed by a period (".") and any 3-character extension. Do not use wild card characters.

Examples `RECALL:WAVEFORM "TEK00000.WFM",REF1`
 recalls the waveform stored in the file named TEK00000.WFM to reference location 1.

REM (No Query Form)

Specifies a comment. This line is ignored by the instrument.

Group Miscellaneous

Syntax `REM <QString>`

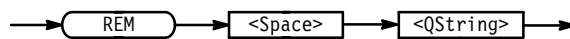

Arguments `<QString>` is a string that can have a maximum of 80 characters.

Examples `REM "This is a comment"`
 is ignored by the instrument.

*RST (No Query Form)

(Reset) returns the digitizing oscilloscope to a known set of instrument settings, but does not purge any aliases or stored settings.

Group Status and Error

Related Commands `FACTory`, `*PSC`, `*RCL`, `RECALL:SETUp`, `*SAV`, `SAVE:SETUp`

Syntax `*RST`

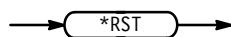

`*RST` returns the instrument settings to the factory defaults (see *Appendix D: Factory Initialization Settings*).

The *RST command does not alter the following:

- The state of the IEEE Std 488.1–1987 interface.
- The selected IEEE Std 488.1–1987 address of the digitizing oscilloscope.
- Calibration data that affect device specifications.
- The Output Queue.
- The Service Request Enable Register setting.
- The Standard Event Status Enable Register setting.
- The Power-on status clear flag setting.
- Alias definitions.
- Stored settings.
- The *PUD? response.

RS232:BAUd

RS-232/Centronics Hardcopy Interface Only

Sets or queries RS-232-C interface transmission speed.

Group RS232

Syntax RS232:BAUd <NR1>
RS232:BAUd?

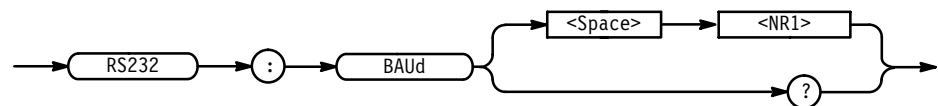

Arguments <NR1> where <NR1> can be 300, 600, 1200, 2400, 4800, 9600 or 19200.

Examples RS232:BAUD 9600
sets the transmission rate to 9600 baud.

RS232:HARDFlagging

RS-232/Centronics Hardcopy Interface Only

Sets or queries the input and output hard flagging over the RS-232 port. It uses the RFR (Ready For Receive) and CTS (Clear To Send) lines to control data transmission. On output, the oscilloscope transmits data only when CTS is asserted. When CTS is not asserted, the oscilloscope stops transmitting data. On input, it asserts RFR until the receive queue is full. Then it unasserts RFR to stop transmission from an external printer. CTS remains unasserted until the receive queue is not full. At that time, CTS is asserted again to restart transmission.

Group RS232

Syntax RS232:HARDFlagging { ON | OFF | <NR1> }
 RS232:HARDFlagging?

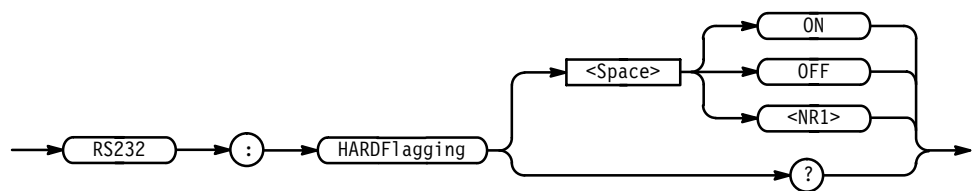

Arguments <ON> or <NR1> ≠ 0 turn on hardflagging.
 <OFF> or <NR1> = 0 turn off hardflagging.

Examples RS232:HARDFLAGGING ON
 turns on hard flagging.

RS232:PARity

RS-232/Centronics Hardcopy Interface Only

Sets or queries the parity used for all RS-232-C data transfers. Parity adds a bit to the character sequence. When parity is odd or even, the digitizing oscilloscope generates the selected parity on output and checks all input against the selected parity. When parity is none, the digitizing oscilloscope performs no input parity error checks and generates no output parity.

Group RS232

Syntax RS232:PARity { EVEN | ODD | NONE }

RS232:PARity?

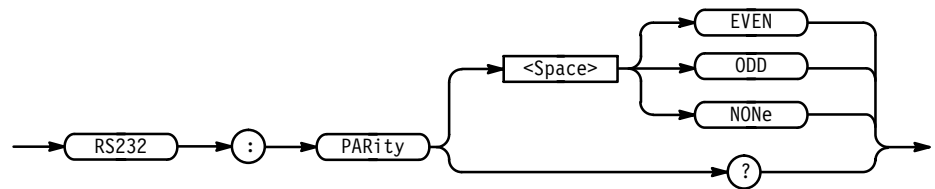

Arguments EVEN indicates the parity bit is sent with even parity and bytes received are expected to have even parity.

ODD indicates the parity bit is sent with odd parity and bytes received are expected to have odd parity.

NONE indicates that no parity bit is sent and none are expected.

Examples RS232:PARITY EVEN
sets the parity to even.

RS232:SOFTFlagging

RS-232/Centronics Hardcopy Interface Only

Sets or queries the input and output soft flagging over the RS-232 port. It stops transmitting data any time it receives an XOFF (DC3) character. It sends an XOFF character when its 512 byte input buffer has 80 free bytes. The digitizing oscilloscope begins transmitting data again when it receives an XON (DC1) character. It sends XON when its input buffer has 100 free bytes.

Group RS232

Syntax RS232:SOFTFlagging { ON | OFF | <NR1> }

RS232:SOFTFlagging?

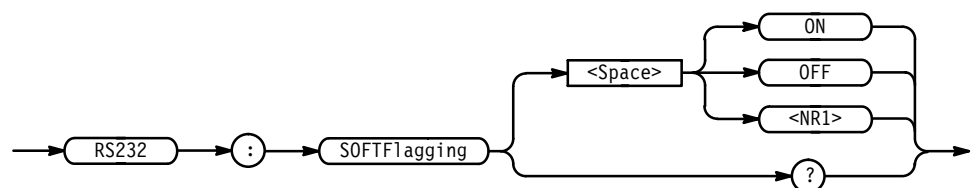

Arguments ON or <NR1> \neq 0 turn on softflagging.
 OFF or <NR1> = 0 turn off softflagging.

Examples RS232:SOFTFLAGGING ON
 turns on soft flagging.

RS232:STOPBits

RS-232/Centronics Hardcopy Interface Only

Sets or queries the number of transmission stop bits sent with each character to identify the end of data for that character.

Group RS232

Syntax RS232:STOPBits <NR1>
 RS232:STOPBits?

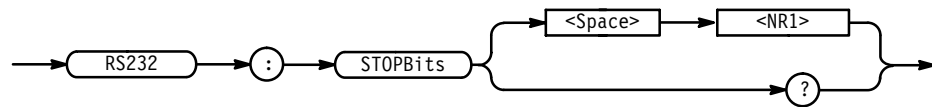

Arguments <NR1> is 1 or 2.

Examples RS232:STOPBITS 1 sets the number of stop bits to 1.

RS232? (Query Only)

RS-232/Centronics Hardcopy Interface Only

Queries the RS232 settings.

Group RS232

Syntax RS232?

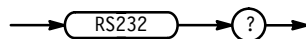

Arguments None

Examples RS232? queries for RS232 settings.

It might return:

```
RS232 BAUD: 9600, SOFTFLAGGING: OFF, HARDFLAGGING: ON, PARITY:
NONE, STOPBITS: 1
```

*SAV (No Query Form)

(Save) stores the state of the digitizing oscilloscope into a specified memory location. You can later use the *RCL command to restore the digitizing oscilloscope to this saved state. This is equivalent to selecting the **Save Current Setup** in the Save/Recall Setup menu.

Group Save and Recall

Related Commands DELEte:SETUp, FACtory, *RCL, RECALL:SETUp, SAVe:SETUp

Syntax *SAV <NR1>

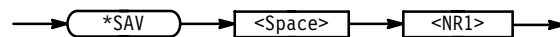

Arguments <NR1> is a value in the range from 1 to 10 and specifies a location. Using an out-of-range value causes an execution error. Any settings that have been stored previously at this location will be overwritten.

Examples *SAV 2
saves the current settings in memory location 2.

SAVe:SETUp (No Query Form)

Saves the current front-panel setup into the specified memory location or file. This is equivalent to selecting the **Save Current Setup** in the Save/Recall Setup menu.

Group Save and Recall

Related Commands DELeTe:SETUp, RECAll:SETUp, *RCL, *SAV

Syntax SAVe:SETUp { <NR1> | <file path> }

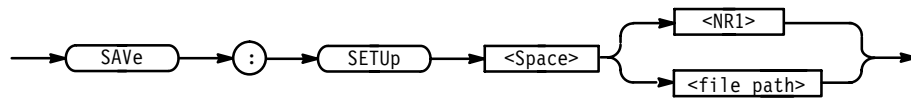

Arguments <NR1> is a value in the range from 1 to 10 and specifies a location. Using an out-of-range value causes an execution error. Any settings that have been stored previously at this location will be overwritten.

<file path> (available on instruments with the Option 1F File System) is a quoted string that defines the file name and path. Input the file path using the form <drive>/<dir>/<filename>. <drive> and one or more <dir>s are optional. If you do not specify them, the TDS will write the file to the default directory. <filename> stands for a filename of up to 8 characters followed by a period (“.”) and the 3-char extension “SET”. The TDS will generate an error if you use any other extension for saving a setup.

Settings saved in one TDS oscilloscope may or may not work on a different model TDS or on the same model TDS with a different version of firmware.

Examples SAVE:SETUP 5
saves the current front-panel setup in memory location 5.

SAVE:SETUP "TEK00000.SET"
saves the current front-panel setup to the file TEK00000.SET in the default directory and on the default drive.

SAVe:WAVEform (No Query Form)

Stores a waveform in one of four reference memory locations or a mass storage file (on instruments with the Option 1F File System). This command is equivalent to selecting either the **Save Waveform** or the **Save to File Waveform** item in the Save/Recall Waveform menu.

Group Save and Recall

Related Commands DELeTe:WAVEFORM, SAVe:WAVEform:FILEFormat

Syntax SAVe:WAVEform <wfm>,{ REF<x> | <file path> }

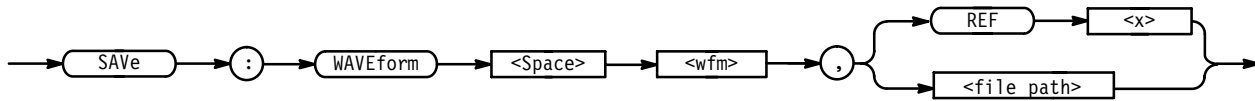

Arguments <wfm> is CH<x>, MATH<x>, or REF<x>, and is the waveform that will be saved.

REF<x> is the location where the waveform will be stored.

<file path> (on instruments with the Option 1F File System) is a quoted string that defines the file name and path. Input the file path using the form <drive>/<dir>/<filename>. <drive> and one or more <dir>s are optional. If you do not specify them, the digitizing oscilloscope will write the file to the default directory. <filename> stands for a filename of up to 8 characters followed by a period (".") and the proper 3-character extension. Internal format waveforms use the "WFM" extension. The TDS 4XXA and TDS 7XXA can also use a "CSV" extension for spreadsheet format files or a "DAT" extension for MathCad format files. The digitizing oscilloscope will generate an error if you use any other extension for saving a waveform.

Examples SAVE:WAVEFORM MATH2,REF1
saves the math 2 waveform in reference memory location 2.

SAVE:WAVEFORM MATH1,"TEK00000.WFM"
saves the math1 waveform to the file TEK00000.WFM in the default directory and on the default drive.

SAVE:WAVEform:FILEFormat

TDS 4XXA & 7XXA Only

Specifies the file format for saved waveforms.

Group Save and Recall

Related Commands SAVE:WAVEFORM

Syntax SAVE:WAVEform:FILEFormat{ INTERNAL | SPREADSheet | MATHCad }
SAVE:WAVEform:FILEFormat?

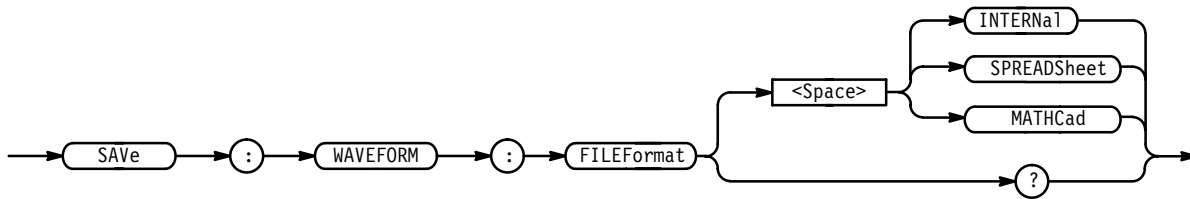

Arguments

INTERNAL specifies the internal format. Internal format files have a .wfm extension.

SPREADSheet specifies the spreadsheet format. Spreadsheet format files have a .CSV extension.

MATHCad specifies the MathCad format. MathCad format files have a .DAT extension.

Examples SAVE:WAVEFORM:FILEFORMAT SPREADSHEET
 specifies the waveform, when saved, will be stored in a spreadsheet-compatible format.

SElect? (Query Only)

Returns the selected waveform and the display status of all waveforms.

Group Vertical

Syntax SElect?

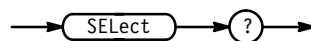

Examples SELECT?
 might return :SELECT:CH1 1;CH2 0;CH3 0;CH4 0;MATH1 0;
 MATH2 0;MATH3 0;REF1 0;REF2 0;REF3 0;REF4 0;SELECT CH1

SElect:<wfm>

Controls the display and selection of waveforms. There can be up to eleven waveforms displayed at one time, but only one waveform can be selected at a time. The selected waveform is the waveform that was most recently turned on. This command is equivalent to pressing a front-panel **CH** or **MORE** button. <wfm> can be CH<x>, MATH<x>, or REF<x>.

Group Vertical

Syntax SElect:<wfm> { OFF | ON | <NR1> }

SElect:<wfm>?

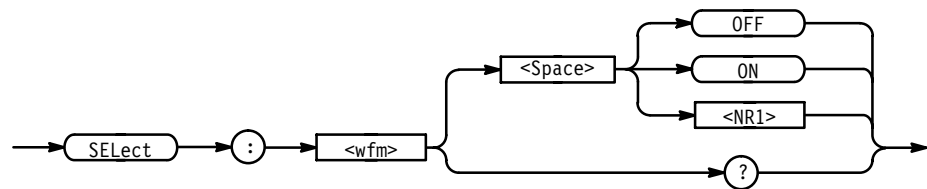

Arguments OFF or <NR1> = 0 turns off the display of the specified waveform.

ON or <NR1> ≠ 0 turns on the display of the specified waveform. The waveform also becomes the selected waveform.

Examples SELECT:CH2 ON
turns the channel 2 display on and selects channel 2.

SELECT:REF1?
returns either 0 or 1, indicating whether the REF1 waveform is selected.

SElect:CONTROL

Sets or queries the waveform that is currently affected by the cursor and vertical commands.

Group Vertical

Syntax SElect:CONTROL <wfm>

SElect:CONTROL?

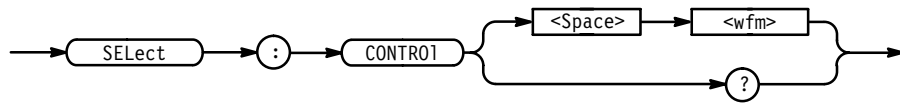

Arguments <wfm> is CH<x>, MATH<x>, or REF<x>, and is the selected waveform.

Examples SELECT:CONTROL?
might return CH1 as the selected waveform.

SET? (Query Only)

Returns a string listing the digitizing oscilloscope settings, except for configuration information for the calibration values. You can use this string to return the digitizing oscilloscope to the state it was in when you made the SET? query. This command is identical to the *LRN? command.

Group Miscellaneous

Related Commands HEADer, *LRN?, VERBose

Syntax SET?



NOTE. The SET? query always returns a string with command headers, regardless of the setting of the HEADer command. This is because the returned string is intended to be able to be sent back to the digitizing oscilloscope as a command string. The VERBose command can still be used to specify whether the returned headers should be abbreviated or full length.

Examples SET?
a partial return string may look like this:
:ACQUIRE:STOPAFTER RUNSTOP;STATE 1;MODE SAMPLE;NUMENV 10;NUMAVG 16;REPET 1;:APPMENU:TITLE "Application Menu";LABEL:BOTTOM1 "";BOTTOM2 "";BOTTOM3 "";BOTTOM4 "";BOTTOM5 "";BOTTOM6 "";BOTTOM7 "";RIGHT1 "";RIGHT2 ""; RIGHT3 "";RIGHT4 "";RIGHT5 "";:HEADER 1;:VERBOSE 1;:ALIAS:STATE 0;:DISPLAY:FORMAT YT;STYLE VECTORS; FILTER SINX;PERSISTENCE 500.0E-3;GRATICULE FULL;TRIGT 1;INTENSITY:OVERALL 85;WAVEFORM 75;TEXT 60;CONTRAST 150;:MESSAGE:SHOW

```
"hello";STATE 1;BOX 74,84,475,135;:LOCK NONE; :HARDCOPY:FORMAT
EPSIMAGE;PORT GPIB;LAYOUT PORTRAIT;
```

*SRE

(Service Request Enable) sets and queries the bits in the Service Request Enable Register (SRER). For a complete discussion of the use of these registers, see page 3–1.

Group Status and Error

Related Commands *CLS, DESE, *ESE, *ESR?, EVENT?, EVMSg?, FACtory, *PSC, *STB?

Syntax *SRE <NR1>

*SRE?

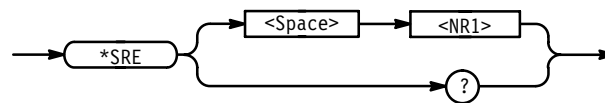

Arguments <NR1> is a value in the range from 0 to 255. The binary bits of the SRER are set according to this value. Using an out-of-range value causes an execution error. The power-on default for SRER is 0 if *PSC is 1. If *PSC is 0, the SRER maintains its value through a power cycle.

Examples *SRE 48
sets the bits in the SRER to 00110000 binary.

*SRE?
might return a value of 32, showing that the bits in the SRER have the binary value 00100000.

*STB? (Query Only)

(Read Status Byte) query returns the contents of the Status Byte Register (SBR) using the Master Summary Status (MSS) bit. For a complete discussion of the use of these registers, see page 3–1.

Group Status and Error

Related Commands *CLS, DESE, *ESE, *ESR?, EVENT?, EVMSg?, FACtory, *SRE

Syntax *STB?

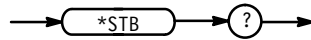

Returns <NR1>

Examples *STB?
 might return the value 96, showing that the SBR contains the binary value 01100000.

TEKSecure

Initializes both waveform and setup memories. This overwrites any previously stored data.

TEKSecure writes zeros in all waveform reference memory, regardless of selected record length, and puts all setups in the factory init state.

TEKSecure then verifies that the waveform and setup memory are in the desired state. It asserts a pass or a fail event on completion.

Group Miscellaneous

Syntax TEKSecure

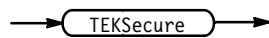

TIME

Sets or queries the time that the digitizing oscilloscope can display.

Group Miscellaneous

Related Commands DATE, DISplay: CLOCK

Syntax TIME <QString>

TIME?

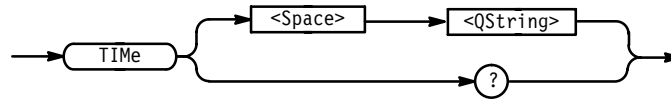

Arguments <QString> is a date in the form "hh:mm:ss".
 hh refers to the hour number from 01 to 24.
 mm refers to the minute number in the hour from 00 to 59.
 ss refers to the seconds number in the minute from 00 to 59.
 There must be a colon after the hh and after the mm.
 Use two digits for each of the hh, mm, and ss.

Examples TIME "01:24:00"
 specifies that the time is set to 01:24 AM.

TRIGger

Forces a trigger event to occur, and the TRIGger query returns the current trigger parameters.

Group Trigger

Syntax TRIGger FORCe

TRIGger?

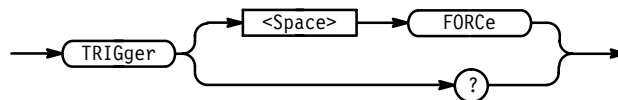

Arguments FORCe creates a trigger event. If TRIGger:STATE is REAdy, the acquisition will complete, otherwise this command will be ignored. This is equivalent to pressing the front-panel **FORCE TRIGGER** button.

Examples TRIGGER FORCe
 forces a trigger event to occur.

TRIGGER?
 might return :TRIGGER:MAIN:MODE AUTO;TYPE EDGE;LEVEL -480.0E-3;

```
HOLDOFF:VALUE 0;:TRIGGER:MAIN:EDGE:SOURCE CH1;COUPLING DC;SLOPE
RISE;:TRIGGER:MAIN:LOGIC:CLASS PATTERN;FUNCTION AND;WHEN
TRUE;THRESHOLD:CH1 1.40E+0;CH2 1.200E+0;CH3 1.200E+0;CH4
1.200E+0;:TRIGGER:MAIN:LOGIC:INPUT:CH1 HIGH;CH2 X;CH3 X;
:TRIGGER:MAIN:LOGIC:PATTERN:INPUT:CH4 X;:TRIGGER:MAIN:LOGIC:
STATE:INPUT:CH4 RISE;:TRIGGER:MAIN:PULSE:CLASS GLITCH;SOURCE CH1;
GLITCH:WIDTH 2.0E-9;FILTER ACCEPT;POLARITY POSITIVE;:TRIGGER:
MAIN:PULSE:RUNT:POLARITY POSITIVE;THRESHOLD:HIGH 2.00E+0;LOW
800.0E-3;:TRIGGER:MAIN:PULSE:WIDTH:LOWLIMIT 2.0E-9;HIGHLIMIT
2.0E-9;WHEN WITHIN;POLARITY POSITIVE;:TRIGGER:DELAY:TYPE
EDGE;LEVEL -480.0E-3;BY TIME; EDGE:SOURCE CH1;SLOPE RISE;COUPLING
DC;:TRIGGER:DELAY:TIME 16.0E-9;EVENTS:COUNT 2
```

TRIGger:DElay

Sets the delayed trigger level and returns the current delayed trigger parameters.

Group Trigger

Syntax TRIGger:DElay SETLevel
TRIGger:DElay?

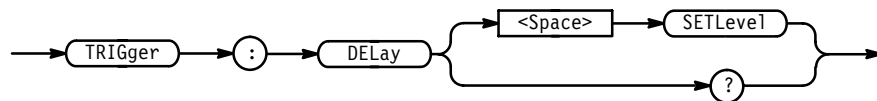

Arguments SETLevel sets the delayed trigger level to half way between the MIN and MAX amplitudes of the trigger source input. This is equivalent to selecting **Set to 50%** in the Delayed Edge Level side menu.

Examples TRIGGER:DELAY SETLEVEL
sets the delayed trigger level to 50% of MAX and MIN.

TRIGGER:DELAY?
might return :TRIGGER:DELAY:TYPE EDGE;LEVEL 0.0E+0;BY
TIME;EDGE:SOURCE CH1;SLOPE RISE;COUPLING DC;:TRIGGER:DELAY:TIME
16.0E-9;EVENTS:COUNT 2

TRIGger:DElay:BY

Selects whether the delayed trigger occurs after a specified number of events or a specified period of time after the main trigger. This is equivalent to setting **Delay by** in the Delayed Trig menu.

Group Trigger

Related Commands TRIGger:DElay:EVENTS:COUNT, TRIGger:DElay:TIME

Syntax TRIGger:DElay:BY
 { EVENTS | EVENTSTime | TIME }
 TRIGger:DElay:BY
 { EVENTS | TIME | EVENTSTime (TDS 5XXA, 6XXA, & 7XXA only) |
 RUNSAfter (TDS 5XXA, 6XXA, & 7XXA only)}
 TRIGger:DElay:BY?

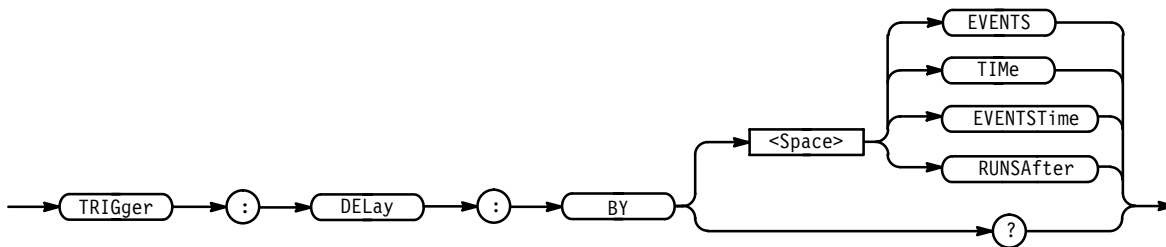

Arguments EVENTS sets the delayed trigger to occur after a set number of trigger events after the main trigger. The number of events is specified by TRIGger:DElay:EVENTS:COUNT.

TIME sets the delayed trigger to be ready to occur a set time after the main trigger event. The time period is specified by TRIGger:DElay:TIME.

EVENTSTime (TDS 5XXA, 6XXA, & 7XXA only) sets a specified time after a specified number of delay trigger trigger events — after the main trigger event. For example in examining a pulse train, you might use the main trigger to detect the start of the train, then use the delay by events to go to the position of interest within the pulse train, and then use the time delay to wait a specified time period before starting the data acquisition.

RUNSAfter (TDS 5XXA, 6XXA, & 7XXA only) looks for a main trigger, then waits a user-specified time, then starts acquiring data.

Examples TRIGGER:DELAY:BY?
might return EVENTS.

TRIGger:DELAy:EDGE? (Query Only)

Returns the coupling, slope, and source for the delayed trigger.

Group Trigger

Syntax TRIGger:DELAy:EDGE?

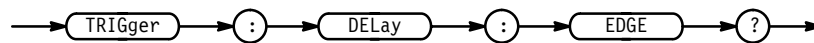

Examples TRIGGER:DELAY:EDGE?
might return :TRIGGER:EDGE:SOURCE CH1;SLOPE RISE;
COUPLING DC

TRIGger:DELAy:EDGE:COUPLing

Selects the type of coupling for the delayed trigger. This command is equivalent to selecting **Coupling** in the Delayed Trig menu.

Group Trigger

Syntax TRIGger:DELAy:EDGE:COUPLing { AC (not on the TDS 684A & 7XXA) | DC | HFRej (not on the TDS 684A & 7XXA) | LFRej (not on the TDS 684A & 7XXA) | MAINTrigger (TDS 684A & 7XXA only) | NOISErej }

TRIGger:DELAy:EDGE:COUPLing?

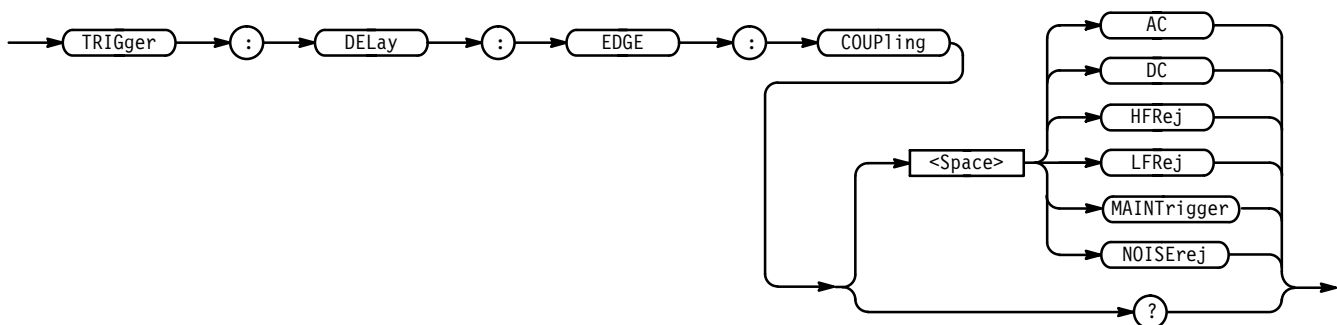

- Arguments**
- AC selects AC trigger coupling (not on TDS 684A & 7XXA).
 - DC selects DC trigger coupling.
 - HFRej coupling removes the high frequency components of the DC signal (not on the TDS 684A & 7XXA).
 - LFRej coupling removes the low frequency components of the AC signal (not on the TDS 684A & 7XXA).
 - MAINTrigger coupling sets the delayed trigger coupling to match the setting on the main trigger (TDS 684A & 7XXA only).
 - NOISErej selects DC low sensitivity.
- Examples**
- TRIGGER:DELAY:EDGE:COUPLING DC sets the delay trigger to DC coupling.
 - TRIGGER:DELAY:EDGE:COUPLING? might return LFREJ for the delayed trigger coupling.

TRIGger:DELAy:EDGE:SLOpe

Selects either a rising or falling edge for the delayed trigger. This command is equivalent to selecting **Slope** in the Delayed Trig menu.

- Group** Trigger
- Syntax** TRIGger:DELAy:EDGE:SLOpe { RISE | FALL }
TRIGger:DELAy:EDGE:SLOpe?

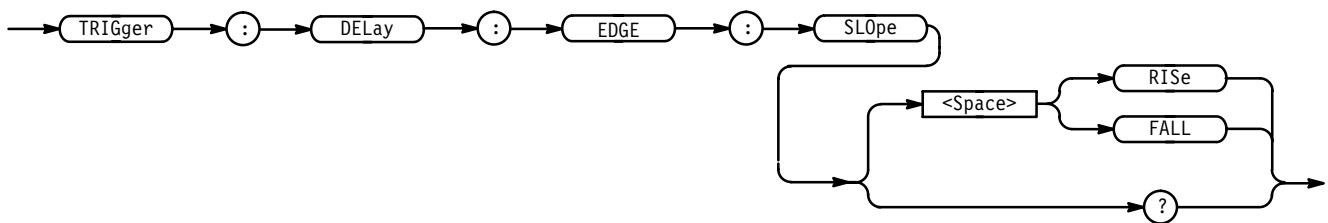

- Arguments**
- FALL specifies to trigger on the falling or negative edge of a signal.
 - RISe specifies to trigger on the rising or positive edge of a signal.

Examples TRIGGER:DELAY:EDGE:SLOPE?
might return RISE, indicating that the delayed trigger occurs on the rising edge.

TRIGger:DELay:EDGE:SOURce

Selects the source for the delayed trigger. This command is equivalent to selecting **Source** in the Delayed Trig menu.

Group Trigger

Syntax TRIGger:DELay:EDGE:SOURce { AUXiliary (not available on TDS 520A & 524A) | CH<x> }
TRIGger:DELay:EDGE:SOURce?

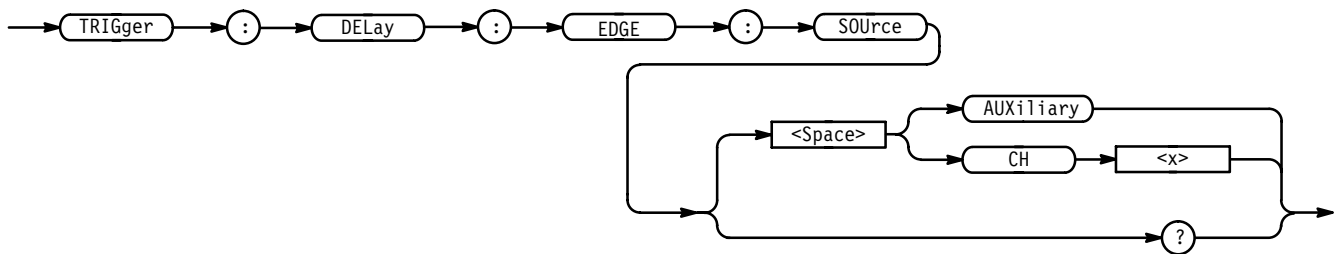

Arguments AUXiliary specifies an external trigger using the Auxiliary Trigger Input connector that is located on the rear panel of the instrument. The TDS 520A & 524A do not have an Auxiliary Trigger input and so do not support this argument.

CH<x> specifies one of the input channels.

Examples TRIGGER:DELAY:EDGE:SOURCE CH1
selects channel 1 as the input source for the delayed trigger.

TRIGger:DELay:EVENTS? (Query Only)

Returns the current delayed trigger event parameter.

Group Trigger

Syntax TRIGger:DELay:EVENTS?

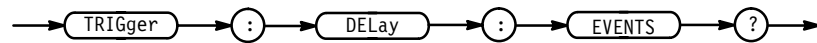

Examples TRIGGER:DELAY:EVENTS?
might return :TRIGGER:DELAY:EVENTS:COUNT 2

TRIGger:DELay:EVENTS:COUNT

Sets or queries the number of events that must occur before the delayed trigger occurs when TRIGger:DELay:BY is set to EVENTS. This is equivalent to setting the **Delay by Events** count in the Delayed Edge Delay side menu.

Group Trigger

Syntax TRIGger:DELay:EVENTS:COUNT <NR1>
TRIGger:DELay:EVENTS:COUNT?

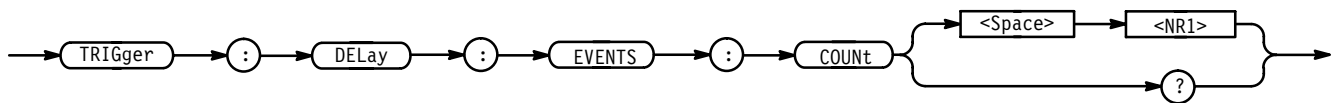

Arguments <NR1> is the number of delayed edge trigger events. The TDS 4XXA range is 1 to (10E7 -1). The TDS 5XXA, 6XXA, and 7XXA range is 2 to 10E7.

Examples TRIGGER:DELAY:EVENTS:COUNT 4
specifies that the delayed trigger will occur four trigger events after the main trigger.

TRIGGER:DELAY:EVENTS:COUNT?
might return 2, indicating that 2 events must occur after the main trigger before the delayed trigger can occur.

TRIGger:DELay:LEVel

Selects the level of the delayed trigger. This command is equivalent to setting **LEVel** in the Delayed Trig menu.

Group Trigger

Syntax TRIGger:DELay:LEVel { ECL | TTL | <NR3> }

TRIGger:DELay:LEVel?

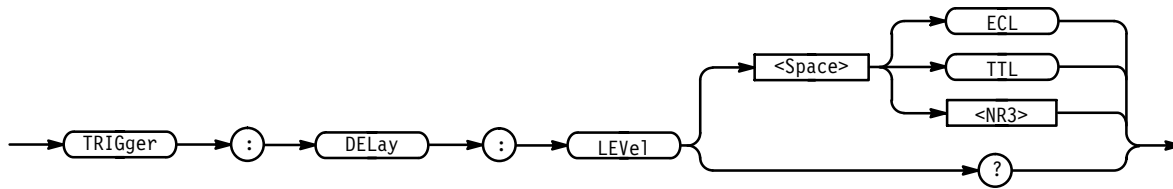

Arguments ECL specifies a preset ECL level of -1.3 V.
 TTL specifies a preset TTL level of 1.4 V.
 <NR3> is the delayed trigger level, in volts.

Examples TRIGGER:DELAY:LEVEL 2E-3
 sets the delayed trigger level to 2 mV.

TRIGger:DELay:TIME

Sets or queries the delay time when HORIZONTAL:DELAY:MODE is set to TRIGAfter. This command is identical to the HORIZONTAL:DELAY:TIME:TRIGAfter command, and is equivalent to setting the **Delay by Time** value in the Delayed Edge Delay side menu.

When HORIZONTAL:DELAY:MODE is set to RUNSAfter, the delay time is set by the HORIZONTAL:DELAY:TIME:RUNSAfter command.

Group Trigger

Related Commands HORIZONTAL:DELAY:MODE, HORIZONTAL:DELAY:TIME:RUNSAfter, HORIZONTAL:DELAY:TIME:TRIGAfter

Syntax TRIGger:DELay:TIME <NR3>
 TRIGger:DELay:TIME?

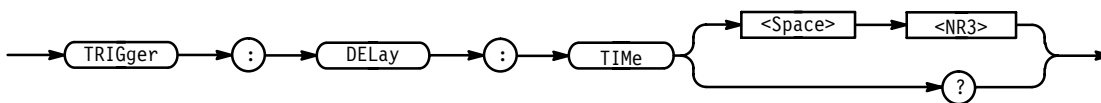

Arguments <NR3> is the delay time, in seconds.

Examples TRIGGER:DELAY:TIME 4E-6
sets the delay time to 4 μ s.

TRIGger:DELAy:TYPE

Sets or queries the type of delayed trigger.

Group Trigger

Syntax TRIGger:DELAy:TYPE EDGE
TRIGger:DELAy:TYPE?

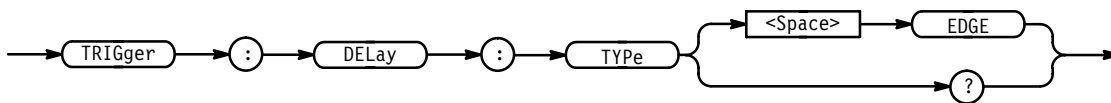

Arguments EDGE is a normal trigger. A trigger event occurs when a signal passes through a specified voltage level in a specified direction. Use the TRIGger:DELAy:LEVel and TRIGger:DELAy:EDGE:SLOpe commands to set the voltage level and direction respectively.

Examples TRIGGER:DELAY:TYPE?
always returns EDGE as the type of delayed trigger.

TRIGger:MAIn

Sets the main trigger level and returns the current main trigger parameters.

Group Trigger

Syntax TRIGger:MAIn SETLevel
TRIGger:MAIn?

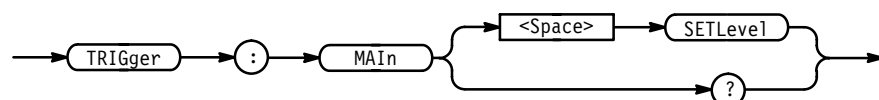

Arguments SETLevel sets the main trigger level to half way between the MIN and MAX amplitudes of the trigger source input. This is equivalent to pressing the front-panel **SET LEVEL TO 50%** button.

Examples TRIGGER:MAIN SETLEVEL
sets the main trigger level mid way between MAX and MIN.

TRIGger:MAIn:EDGE? (Query Only)

Returns the trigger coupling, source, and slope for the main edge trigger.

Group Trigger

Syntax TRIGger:MAIn:EDGE?

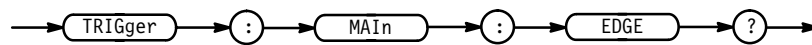

Examples TRIGGER:MAIN:EDGE?
might return SOURCE CH1;COUPLING DC;SLOPE RISE

TRIGger:MAIn:EDGE:COUPLing

Sets or queries the type of coupling for the main edge trigger. This is equivalent to setting **Coupling** in the Trigger menu.

Group Trigger

Syntax TRIGger:MAIn:EDGE:COUPLing { AC | DC | HFRej | LFRej | NOISErej }
TRIGger:MAIn:EDGE:COUPLing?

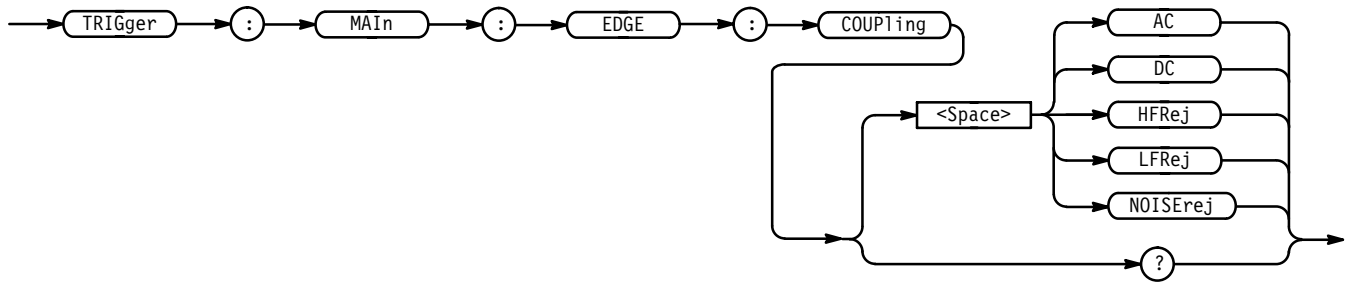

- Arguments**
- AC selects AC trigger coupling.
 - DC selects DC trigger coupling.
 - HFRej coupling removes the high frequency components of the DC signal.
 - LFRej coupling removes the low frequency components of the AC signal.
 - NOISErej selects DC low sensitivity. It requires added signal amplitude for more stable, less false triggering.

Examples TRIGGER:MAIN:EDGE:COUPLING DC
sets the main edge trigger coupling to DC.

TRIGGER:MAIN:EDGE:SLOPE

Selects a rising or falling slope for the main edge trigger. This is equivalent to setting **Slope** in the Trigger menu.

Group Trigger

Syntax TRIGGER:MAIN:EDGE:SLOPE { FALL | RISE }
TRIGGER:MAIN:EDGE:SLOPE?

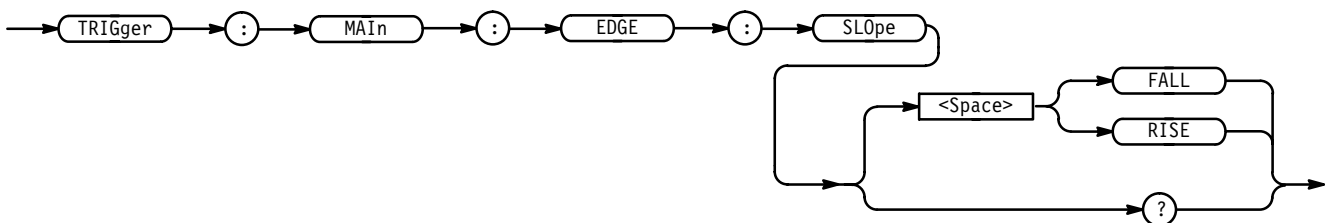

- Arguments**
- FALL specifies to trigger on the falling or negative edge of a signal.
 - RISE specifies to trigger on the rising or positive edge of a signal.

Examples TRIGGER:MAIN:EDGE:SLOPE RISE
sets the main edge trigger to occur on the rising slope.

TRIGger:MAIn:EDGE:SOURce

Sets or queries the source for the main edge trigger. This is equivalent to setting **Source** in the Trigger menu.

Group Trigger

Syntax TRIGger:MAIn:EDGE:SOURce { AUXiliary (not available on TDS 520A & TDS 524A) | CH<x> | LINE }
TRIGger:MAIn:EDGE:SOURce?

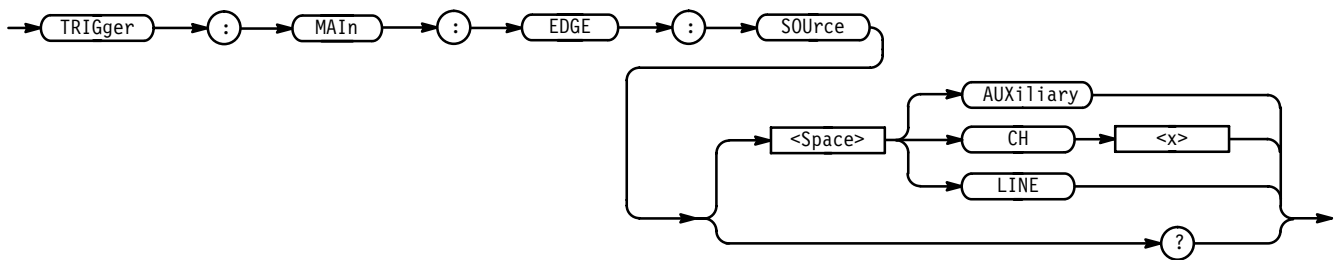

Arguments CH<x> specifies one of the input channels.
LINE specifies AC line voltage.

Examples TRIGGER:MAIN:EDGE:SOURCE LINE
specifies the AC line voltage as the main edge trigger source.
TRIGGER:MAIN:EDGE:SOURCE?
might return CH2 for the main edge trigger source.

TRIGger:MAIn:HOLdoff? (Query Only)

For TDS 684A and 7XXA, returns the main trigger holdoff default (TIME or DEFAult) and main trigger holdoff time. For other TDS (4XXA, 5XXA, 620A, 640A, 644A) returns the main trigger holdoff value.

Group Trigger

Syntax TRIGger:MAIn:HOLdoff?

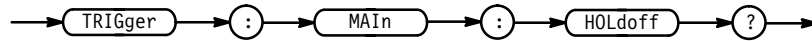

Examples TRIGGER:MAIN:HOLDOFF?
 for the TDS 684A and 7XXA, might return
 :TRIGGER:MAIN:HOLDOFF:TIME 250.0E-9;BY DEFAULT
 or, for other TDS 4XXA, 5XXA, and 6XXA, might return
 :TRIGGER:MAIN:HOLDOFF:VALUE 0.

TRIGger:MAIn:HOLdoff:ACTUal? (Query Only)

TDS 684A and 7XXA Only

Returns the main trigger holdoff value in seconds. This is equivalent to selecting **Mode & Holdoff** from the main Trigger menu and viewing the value in the side menu **Holdoff Default** or **Holdoff Time** items (whichever is highlighted).

Group Trigger

Syntax TRIGger:MAIn:HOLdoff:ACTUal?

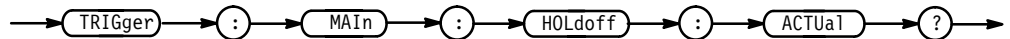

Examples TRIGGER:MAIN:HOLDOFF:ACTUAL?
 might return 4E-6 showing the holdoff time is set to 4 μ s.

TRIGger:MAIn:HOLdoff:BY

TDS 684A & 7XXA Only

Sets or queries the main trigger holdoff default. This is equivalent to selecting **Mode & Holdoff** from the main Trigger menu, then setting **Default Holdoff** or **Holdoff (Time)** in the resulting side menu.

Group Trigger

Syntax TRIGger:MAIn:HOLdoff:BY { TIME | DEFAUlt }

TRIGger:MAIn:HOLdoff:BY?

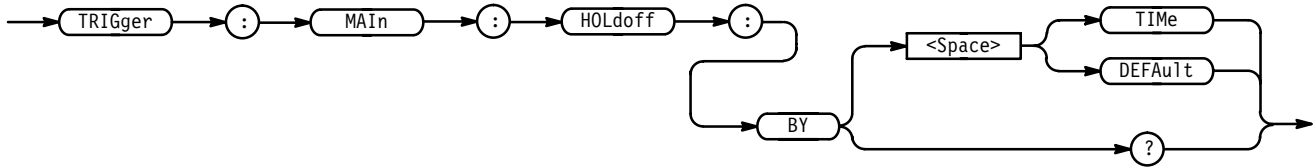

Arguments TIME enables the user to set the holdoff time.

DEFAUlt automatically calculates a holdoff time to use. This time is typically equivalent to the greater of 1/2 screen (5 divisions) of time or 250 ns. The maximum value is 12 seconds. For example, if the oscilloscope is set to 1 msec/division then the default holdoff will be 1 msec/division × 25 divs = 25 msec.

Examples TRIGGER:MAIN:HOLDOFF:BY TIME
set the holdoff to the by time setting. This enables the user to set the holdoff time.

TRIGger:MAIn:HOLdoff:TIME

TDS 684A & 7XXA Only

Sets or queries the main trigger holdoff time. This is equivalent to setting **Holdoff Time** in the Mode & Holdoff side menu.

Group Trigger

Syntax TRIGger:MAIn:HOLdoff:TIME <NR3>

TRIGger:MAIn:HOLdoff:TIME?

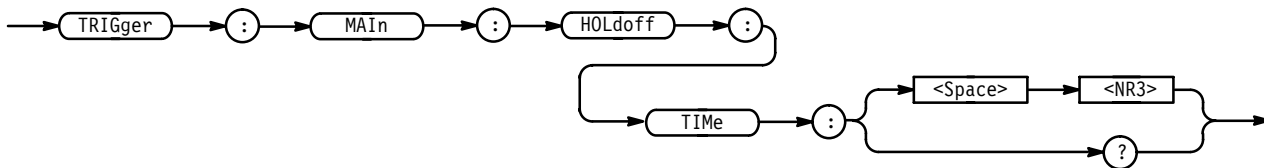

Arguments <NR3> holdoff time in seconds. The range is 250 ns to 12.0 seconds.

Examples TRIGGER:MAIN:HOLDOFF:TIME 10
sets the holdoff time to be 10 seconds.

TRIGger:MAIn:HOLdoff:VALue

Not in TDS 684A & 7XXA

Sets or queries the main trigger holdoff value. This is equivalent to setting **Holdoff** in the Mode & Holdoff side menu.

Group Trigger

Syntax TRIGger:MAIn:HOLdoff:VALue <NR1>
TRIGger:MAIn:HOLdoff:VALue?

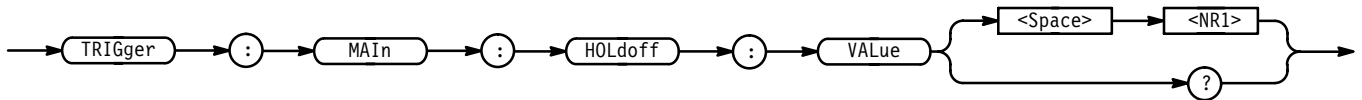

Arguments <NR1> is from 0 to 100, and is a percent of the holdoff range.

Examples TRIGGER:MAIN:HOLDOFF:VALUE 10
set the holdoff value to be 10% of the holdoff range.

TRIGger:MAIn:LEVel

Sets the main trigger level. This command is equivalent to adjusting the front-panel **TRIGGER MAIN LEVEL** knob.

Group Trigger

Syntax TRIGger:MAIn:LEVel { ECL | TTL | <NR3> }
TRIGger:MAIn:LEVel?

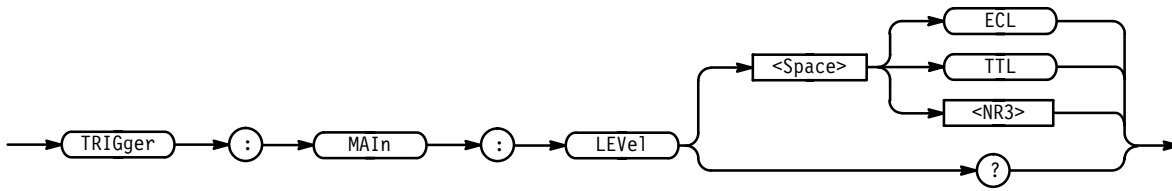

Arguments ECL specifies a preset ECL level of -1.3 V.
 TTL specifies a preset TTL level of 1.4 V.
 <NR3> is the main trigger level, in volts.

Examples TRIGGER:MAIN:LEVEL?
 might return TTL, indicating that the main edge trigger is set to 1.4 V.

TRIGger:MAIn:LOGIc? (Query Only)

TDS 5XXA, 6XXA, & 7XXA Only

Returns all main logic trigger parameters.

Group Trigger

Syntax TRIGger:MAIn:LOGIc?

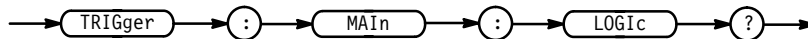

Examples TRIGGER:MAIN:LOGIC?
 might return :TRIGGER:MAIN:LOGIC:CLASS PATTERN;
 FUNCTION AND;WHEN TRUE;THRESHOLD:CH1 0;CH2 0;CH3 0;
 CH4 0;:TRIGGER:MAIN:LOGIC:INPUT:CH1 HIGH;CH2 X;
 CH3 X;:TRIGGER:MAIN:LOGIC:PATTERN:INPUT:CH4 X;
 :TRIGGER:MAIN:LOGIC:STATE:INPUT:CH4 RISE

TRIGger:MAIn:LOGIc:CLAss

TDS 5XXA, 6XXA, & 7XXA Only

Sets or queries the type of main logic trigger. This command is equivalent to selecting **Class** in the Trigger menu when the **Type** is set to Logic.

Group Trigger

Syntax TRIGger:MAIn:LOGIc:CLAss { PATtern | STATE
SETHold (TDS 684A & 7XXA only)}
TRIGger:MAIn:LOGIc:CLAss?

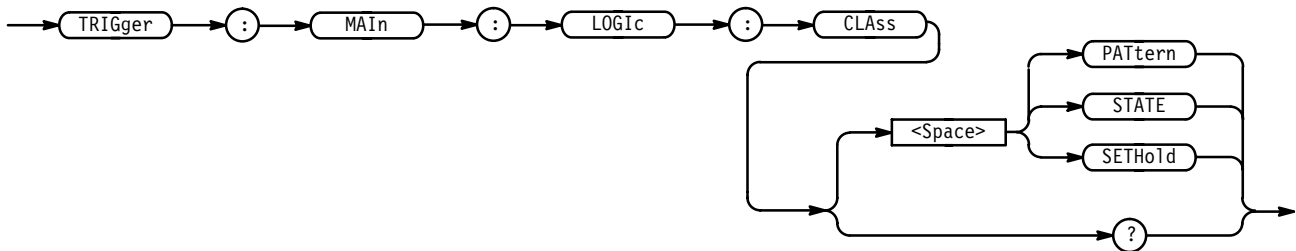

Arguments PATtern means that the instrument triggers when the specified logical combinations of channels 1, 2, 3, and 4 are met.

STATE means that the instrument triggers when the specified conditions of channels 1, 2, and 3 are met after the channel 4 condition is met.

SETHold means the oscilloscope will trigger on the setup and hold violations between a data source and a clock source (TDS 684A & 7XXA only).

Examples TRIGGER:MAIN:LOGIC:CLASS?
might return STATE.

TRIGger:MAIn:LOGIc:FUNCTion

TDS 5XXA, 6XXA, & 7XXA Only

Sets or queries the logical combination of the input channels for the main logic trigger.

When TRIGger:MAIn:LOGIc:CLAss is PATtern, this command applies to channels 1, 2, 3, and 4. When TRIGger:MAIn:LOGIc:CLAss is STATE, only channels 1, 2, and 3 are logically combined. This command is equivalent to selecting the function in the Logic Pattern Function side menu.

Group Trigger

Syntax TRIGger:MAIn:LOGIc:FUNCTion { AND | NAND | NOR | OR }
TRIGger:MAIn:LOGIc:FUNCTion?

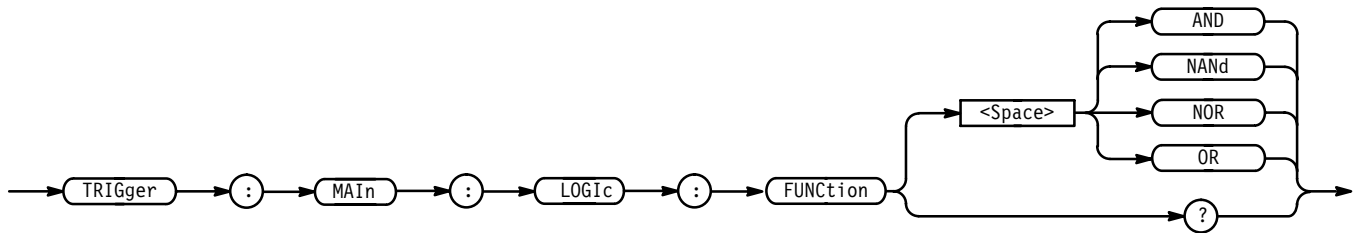

Arguments AND specifies that the instrument will trigger if all the conditions are true.
 NAND specifies that the instrument will trigger if any of the conditions are false.
 NOR specifies that the instrument will trigger if all of the conditions are false.
 OR specifies that the instrument will trigger if any of the conditions are true.

Examples TRIGGER:MAIN:LOGIC:FUNCTION NOR
 sets the logical combination of channels to be true when none of the conditions
 are true.
 TRIGGER:MAIN:LOGIC:FUNCTION?
 might return NAND.

TRIGGER:MAIN:LOGIC:INPUT? (Query Only)

TDS 5XXA, 6XXA, & 7XXA Only

Returns the main logic trigger input for all channels.

Group Trigger

Syntax TRIGGER:MAIN:LOGIC:INPUT?

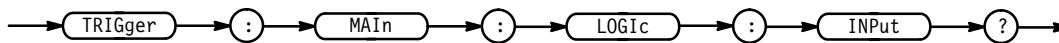

Examples TRIGGER:MAIN:LOGIC:INPUT?
 might return :TRIGGER:MAIN:LOGIC:INPUT:CH1 HIGH;CH2 X;CH3 X

TRIGger:MAIn:LOGIc:INPut:CH<x>*TDS 5XXA, 6XXA, & 7XXA Only*

Sets or queries the main logic trigger input for the specified channel. The channel is specified by <x> and is 1, 2, or 3. This is equivalent to setting the inputs in the Logic Pattern Inputs side menu.

Group Trigger

Related Commands TRIGger:MAIn:LOGIc:CLAss

Syntax TRIGger:MAIn:LOGIc:INPut:CH<x> { HIGH | LOW | X }
TRIGger:MAIn:LOGIc:INPut:CH<x>?

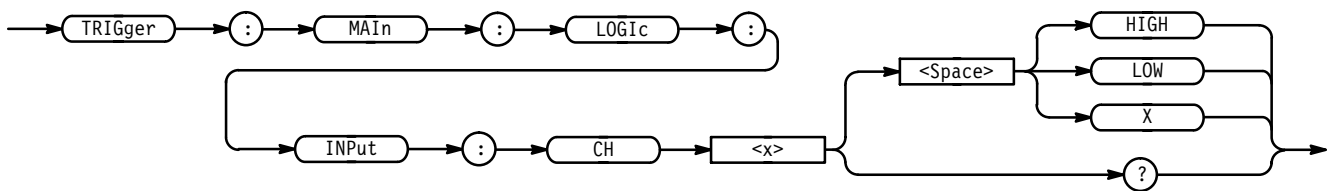

Arguments HIGH specifies logic high.
LOW specifies logic low.
X specifies a do not care state.

Examples TRIGGER:MAIN:LOGIC:INPUT:CH2 LOW
sets the main logic trigger input to logic low for channel 2.

TRIGger:MAIn:LOGIc:PATtern:INPut:CH4*TDS 5XXA, 6XXA, & 7XXA Only*

Sets or queries the main logic trigger input for channel 4. These are the inputs used when TRIGger:MAIn:LOGIc:CLAss is set to PATtern. This is equivalent to setting the channel 4 input in the Logic Pattern Inputs side menu.

Group Trigger

Related Commands TRIGger:MAIn:LOGIc:CLAss

Syntax TRIGger:MAIn:LOGIc:PATtern:INPut:CH4 { HIGH | LOW | X }
 TRIGger:MAIn:LOGIc:PATtern:INPut:CH4?

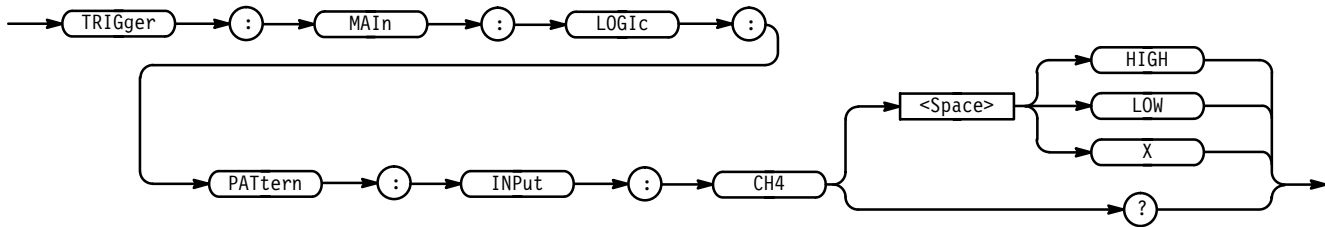

Arguments HIGH specifies logic high.
 LOW specifies logic low.
 X specifies a do not care state.

Examples TRIGGER:MAIN:LOGIC:PATTERN:INPUT:CH4 LOW
 sets the main logic trigger input to logic low for channel 4 when the logic class is set to PATTERN.

TRIGGER:MAIN:LOGIC:PATTERN:INPUT:CH4?
 might return X, indicating that the logic input for channel 4 is do not care.

TRIGger:MAIn:LOGIc:PATtern:WHEn

TDS 5XXA, 6XXA, & 7XXA Only

Sets or queries a condition for generating a main logic pattern trigger.

Group Trigger

Syntax TRIGger:MAIn:LOGIc:PATtern:WHEn { TRUe | FALSE | LESSThan | MOREThan }
 TRIGger:MAIn: LOGIc: PATtern: WHEn?

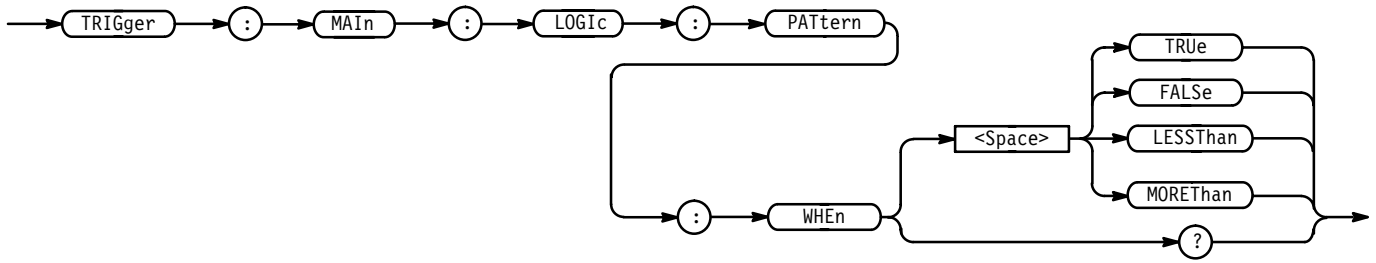

- Arguments**
- TRUe specifies the trigger to occur when the pattern becomes true.
 - FALSe specifies the trigger to occur when the pattern becomes false.
 - LESSThan specifies trigger to occur if the specific pattern is true less than the LESSLimit. (see Figure 2-5 and TRIGger:MAIn:LOGic:PATtern:WHEn:LESSLimit) Trigger is evaluated at the true-false transition.
 - MOREThan specifies trigger to occur if the specific pattern is true longer than the more limit. (see Figure 2-5 and TRIGger:MAIn:LOGic:PATtern:WHEn:MORELimit) Trigger is evaluated at the true-false transition.

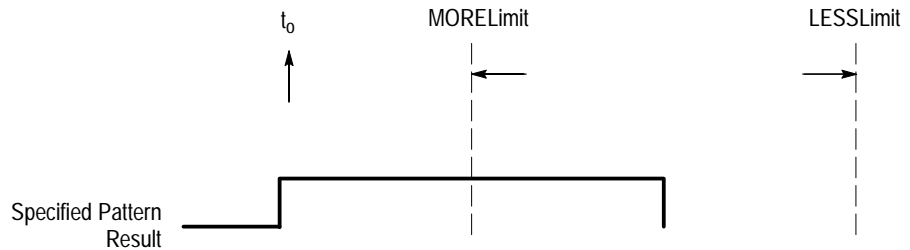

Figure 2-5: LESSThan and MOREThan Arguments

TRIGger:MAIn:LOGic:PATtern:WHEn:LESSLimit

TDS 5XXA, 6XXA, & 7XXA Only

Sets or queries the maximum time the selected pattern may be true and still generate a main logic pattern trigger.

- Group** Trigger
- Syntax** TRIGger:MAIn:LOGic:PATtern:WHEn:LESSLimit <NR3>
 TRIGger:MAIn: LOGic: PATtern: WHEn: LESSLimit?

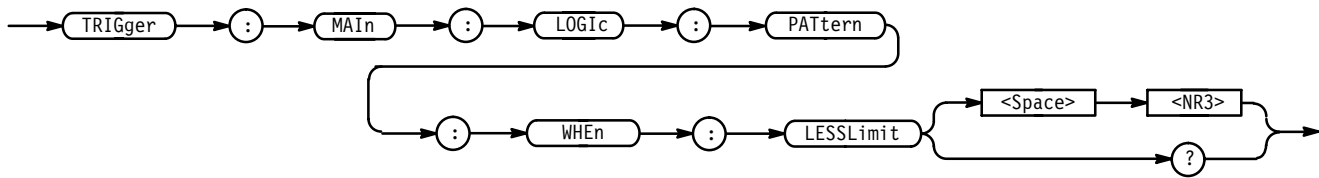

Arguments <NR3> time to hold pattern true.

TRIGger:MAIn:LOGIc:PATtern:WHEn:MORELimit

TDS 5XXA, 6XXA, & 7XXA Only

Sets or queries the minimum time the selected pattern may be true and still generate a main logic pattern trigger.

Group Trigger

Syntax TRIGger:MAIn:LOGIc:PATtern:WHEn:MORELimit <NR3>

TRIGger:MAIn: LOGIc: PATtern: WHEn: MORELimit?

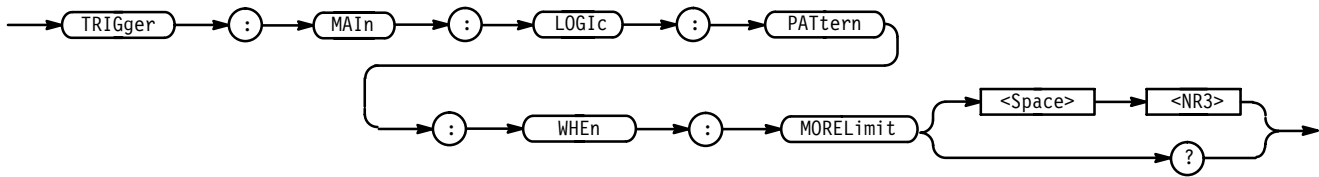

Arguments <NR3> time to hold pattern true.

TRIGger:MAIn:LOGIc:SETHold:CLOCK:EDGE

TDS 684A & 7XXA only

Sets or queries the clock edge polarity for setup and hold violation triggering. This is equivalent to selecting **Define Clock** from the main Trigger menu and **Polarity** in the resulting side menu.

Group Trigger

Syntax TRIGger:MAIn:LOGIc:SETHold:CLOCK:EDGE { FALL | RISE }

TRIGger:MAIn:LOGIc:SETHold:CLOCK:EDGE?

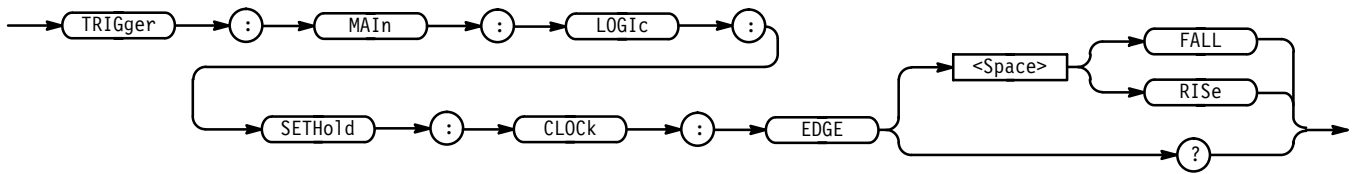

Arguments FALL specifies falling edge.
RISe specifies rising edge.

Examples TRIGGER:MAIN:LOGIC:SETHOLD:CLOCK:EDGE RISE
specifies the polarity as the rising edge.

TRIGGER:MAIN:LOGIC:SETHOLD:CLOCK:LEVEL

TDS 684A & 7XXA only

Sets or queries the main logic setup/hold clock voltage trigger level. This is equivalent to selecting **Levels** from the main Trigger menu and **Clock Level** in the resulting side menu.

Group Trigger

Syntax TRIGGER:MAIN:LOGIC:SETHOLD:CLOCK:LEVEL { ECL | TTL | <NR3> }
TRIGGER:MAIN:LOGIC:SETHOLD:CLOCK:LEVEL?

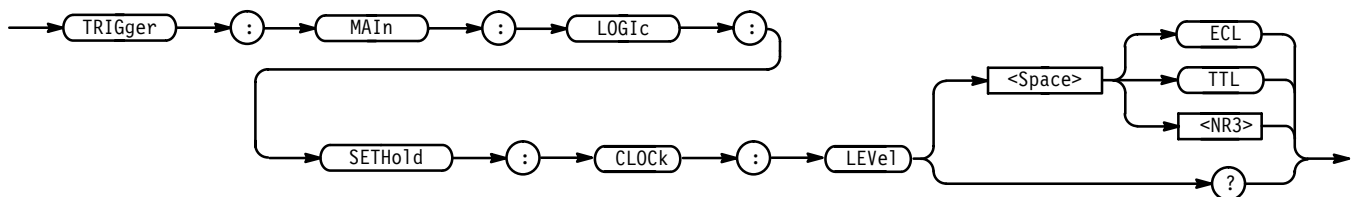

Arguments ECL specifies a preset ECL level of -1.3 V.
TTL specifies a preset TTL level of 1.4 V.
<NR3> is the main trigger level, in volts.

Examples TRIGGER:MAIN:LOGIC:SETHOLD:CLOCK:LEVEL 1.4
sets the main logic trigger setup/hold clock level to 1.4 volts.

TRIGger:MAIn:LOGIc:SETHold:CLOCK:SOURce

TDS 684A & 7XXA Only

Sets or queries the source for the clock for the main logic trigger setup/hold input. The channel is specified by <x> and is 1, 2, 3, or 4. This is equivalent to selecting **Define Clock** from the main Trigger menu and **CH1**, **CH2**, **CH3**, or **CH4** in the resulting side menu.

Group Trigger

Related Commands TRIGger:MAIn:LOGIc:CLAss

Syntax TRIGger:MAIn:LOGIc:SETHold:CLOCK:SOURce: CH<x>
 TRIGger:MAIn:LOGIc:SETHold:CLOCK:SOURce?

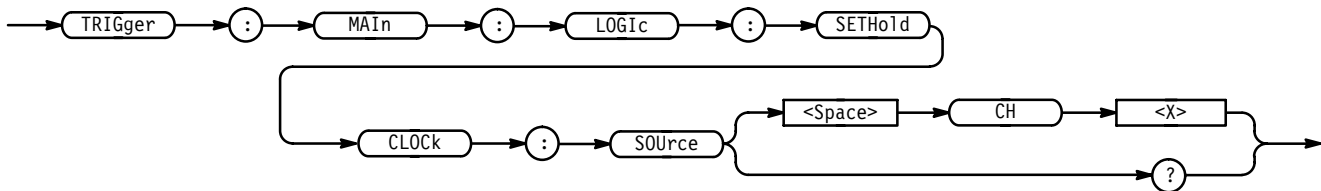

Arguments CH<x> specifies one of the input channels (CH1, CH2, CH3, or CH4).

Examples TRIGGER:MAIN:LOGIC:SETHOLD:CLOCK:SOURCE CH2
 selects Channel 2 as the clock source for the main logic trigger setup/hold.

TRIGger:MAIn:LOGIc:SETHold:DATA:LEVel

TDS 684A & 7XXA only

Sets or queries the main logic set/hold data level. This is equivalent to selecting **Levels** from the main Trigger menu and **Data Level** in the resulting side menu.

Group Trigger

Syntax TRIGger:MAIn:LOGIc:SETHold:DATA:LEVel { ECL | TTL | <NR3> }
 TRIGger:MAIn:LOGIc:SETHold:DATA:LEVel?

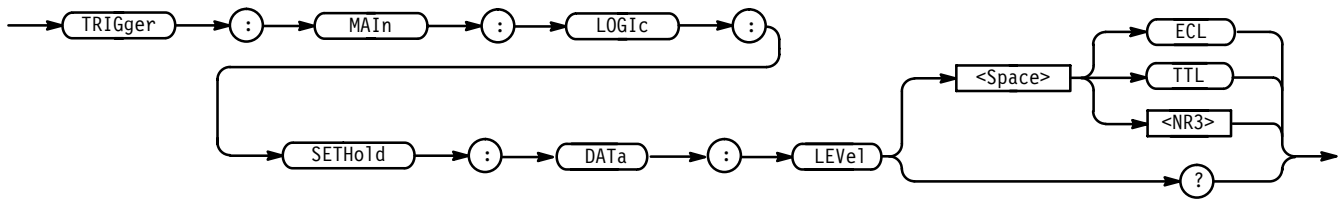

Arguments ECL specifies a preset ECL level of -1.3 V.
 TTL specifies a preset TTL level of 1.4 V.
 <NR3> is the main trigger level, in volts.

Examples TRIGGER:MAIN:LOGIC:SETHOLD:DATA:LEVEL 1.4
 sets the main logic setup/hold data level to 1.4 volts.

TRIGGER:MAIN:LOGIC:SETHOLD:DATA:SOURCE

TDS 684A & 7XXA Only

Sets or queries the data channel for the main logic trigger set/hold input. The channel is specified by <x> and is 1, 2, 3, or 4. This is equivalent to selecting **Data Source** from the main Trigger menu and **CH1**, **CH2**, **CH3**, or **CH4** in the resulting side menu.

Group Trigger

Related Commands TRIGGER:MAIN:LOGIC:CLASS

Syntax TRIGGER:MAIN:LOGIC:SETHOLD:DATA:SOURCE CH<x>
 TRIGGER:MAIN:LOGIC:SETHOLD:DATA:SOURCE?

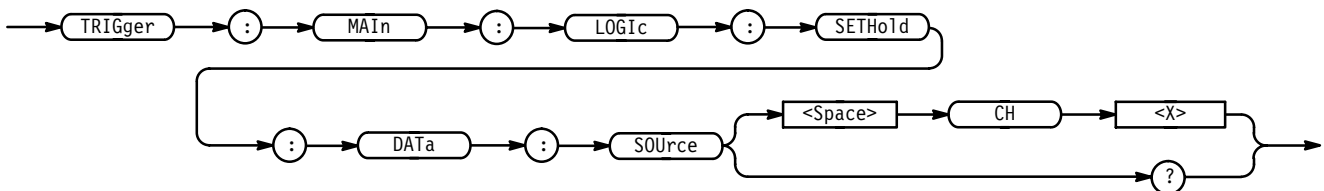

Arguments CH<x> specifies one of the input channels (CH1, CH2, CH3, or CH4)

Examples TRIGGER:MAIN:LOGIC:SETHOLD:DATA:SOURCE CH2
 selects Channel 2 as the source for the main logic trigger set/hold.

TRIGger:MAIn:LOGIc:SETHold:HOLDTime

TDS 684A & 7XXA only

Sets or queries the main logic trigger hold time. This is equivalent to selecting **Setup/Hold Times** from the main Trigger menu and **Hold Time** in the resulting side menu.

Group Trigger

Syntax TRIGger:MAIn:LOGIc:SETHold:HOLDTime <NR3>
 TRIGger:MAIn:LOGIc:SETHold:HOLDTime?

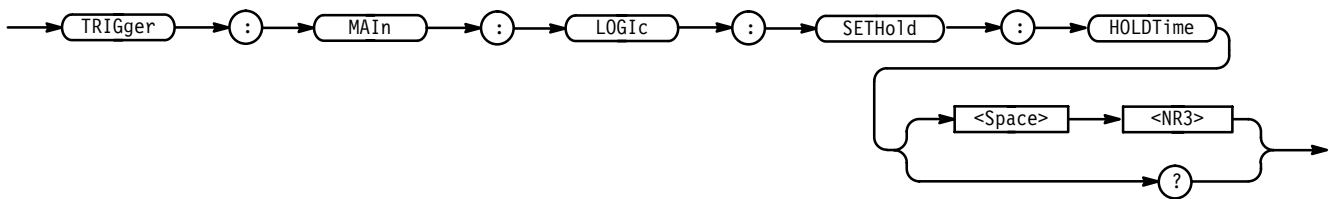

Arguments <NR3> specifies the hold time setting in seconds. Positive values for hold time occur after the clock edge. Negative values occur before the clock edge.

Examples TRIGGER:MAIN:LOGIC:SETHOLD:HOLDTIME 200 E-12
 sets the main logic trigger sethold holdtime to 200 nanoseconds.

TRIGger:MAIn:LOGIc:SETHold:SETTime

TDS 684A & 7XXA only

Sets or queries the main logic trigger set time. This is equivalent to selecting **Setup/Hold Times** from the main Trigger menu and **Setup Time** in the resulting side menu.

Group Trigger

Syntax TRIGger:MAIn:LOGIc:SETHold:SETTime <NR3>
 TRIGger:MAIn:LOGIc:SETHold:SETTime?

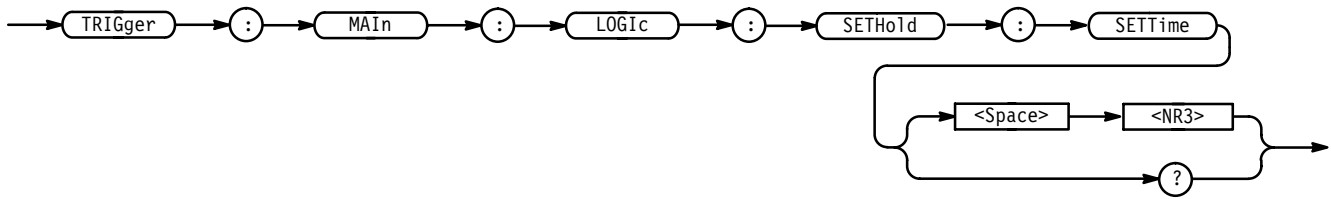

Arguments <NR3> specifies the setup time setting in seconds. Positive values occur before the clock edge. Negative values occur after the clock edge.

Examples TRIGGER:MAIN:LOGIC:SETHOLD:SETTIME 600 E-12
sets the main logic trigger sethold time to 600 nanoseconds.

TRIGGER:MAIN:LOGIC:STATE:INPUT:CH4

TDS 5XXA, 6XXA, & 7XXA Only

Sets or queries the main logic trigger input for channel 4. This input is used when TRIGGER:MAIN:LOGIC:CLASS is set to STATE. This is equivalent to setting the channel 4 input in the Logic Pattern Inputs side menu.

Group Trigger

Syntax TRIGGER:MAIN:LOGIC:STATE:INPUT:CH4 { FALL | RISE }
TRIGGER:MAIN:LOGIC:STATE:INPUT:CH4?

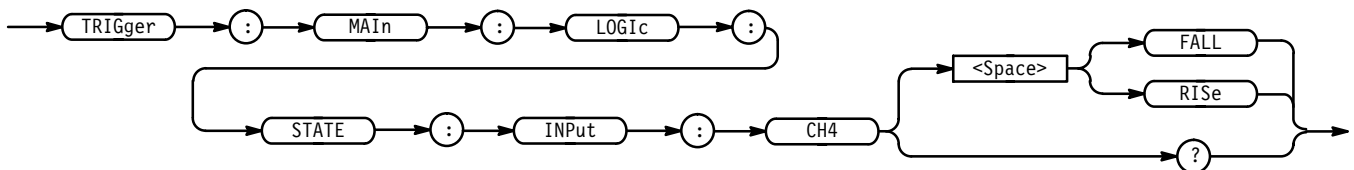

Arguments FALL specifies falling edge.
RISE specifies rising edge.

Examples TRIGGER:MAIN:LOGIC:STATE:INPUT:CH4 RISE
specifies that the main logic trigger input for channel 4 is the rising edge when the logic class is set to STATE.

TRIGger:MAIn:LOGIc:STATE:WHEn

TDS 5XXA, 6XXA, & 7XXA Only

Sets or queries the main logic state trigger.

Group Trigger

Syntax TRIGger:MAIn:LOGIc:STATE:WHEn { TRUe | FALSe }
 TRIGger:MAIn:LOGIc:STATE:WHEn ?

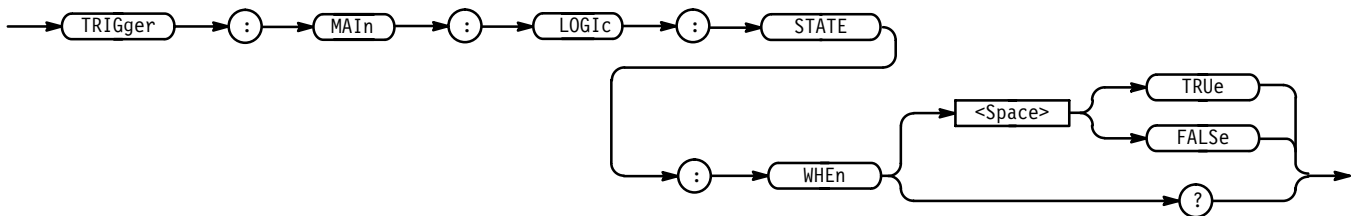

Arguments TRUe specifies the trigger to occur when the condition is met on the fourth channel and the pattern of the first three channels are at the desired states.
 FALSe

TRIGger:MAIn:LOGIc:THReshold? (Query Only)

TDS 5XXA, 6XXA, & 7XXA Only

Returns the main logic trigger threshold voltage for all channels.

Group Trigger

Syntax TRIGger:MAIn:LOGIc:THReshold?

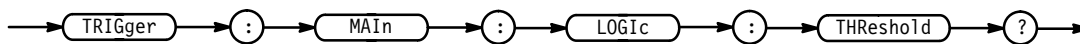

Examples TRIGGER:MAIN:LOGIC:THRESHOLD?
 might return :TRIGGER:MAIN:LOGIC:THRESHOLD:CH1 0;CH2 0;
 CH3 0;CH4 0

TRIGger:MAIn:LOGIc:THReshold:CH<x>

TDS 5XXA, 6XXA, & 7XXA Only

Sets or queries the main logic trigger threshold voltage for the channel specified by <x>. This is equivalent to setting the thresholds in the Logic State Threshold and Logic Pattern Threshold side menus.

Group Trigger

Syntax TRIGger:MAIn:LOGIc:THReshold:CH<x> <NR3>

TRIGger:MAIn:LOGIc:THReshold:CH<x>?

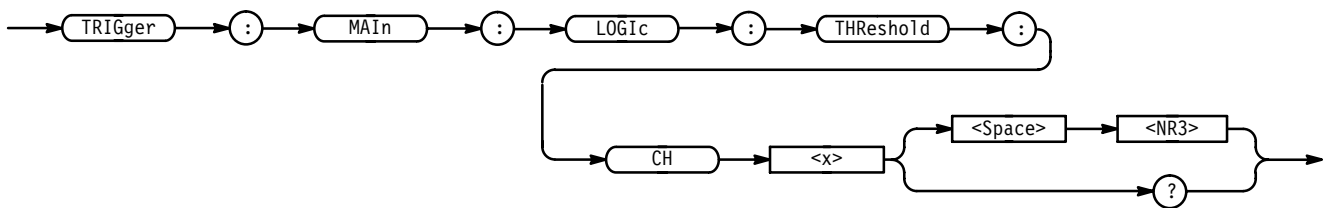

Arguments <NR3> specifies the threshold voltage.

Examples TRIGGER:MAIN:LOGIC:THRESHOLD:CH1 .5
sets the main logic trigger threshold for channel 1 to .5 volts.

TRIGger:MAIn:LOGIc:WHEn

TDS 5XXA, 6XXA, & 7XXA Only

Specifies whether the main logic trigger occurs when the specified state goes true or false when TRIGger:MAIn:LOGIc:CLAss is set to PATtern. This is equivalent to selecting **Trigger When** in the Trigger menu.

Group Trigger

Syntax TRIGger:MAIn:LOGIc:WHEn { FALSE | TRUE }

TRIGger:MAIn:LOGIc:WHEn?

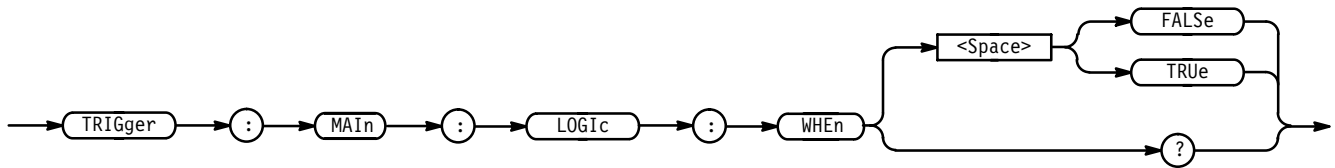

Examples TRIGGER:MAIN:LOGIC:WHEN TRUE
 specifies that the main logic trigger when the logic pattern is true.

TRIGger:MAIn:MODE

Sets or queries the main trigger mode. This command is equivalent to selecting **Mode & Holdoff** in the Trigger menu.

Group Trigger

Syntax TRIGger:MAIn:MODE { AUTO | NORMa1 }
 TRIGger:MAIn:MODE?

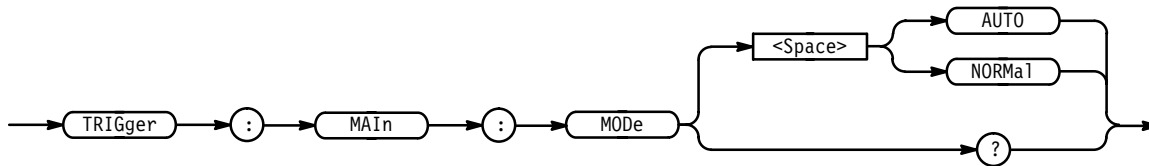

Arguments AUTO generates a trigger if a trigger is not detected within a specific time period.
 NORMa1 waits for a valid trigger event.

Examples TRIGGER:MAIN:MODE AUTO
 specifies that a trigger event is automatically generated.

TRIGger:MAIn:PULse? (Query Only)

TDS 5XXA, 6XXA, & 7XXA Only

Returns the main pulse trigger parameters.

Group Trigger

Syntax TRIGger:MAIn:PULse?

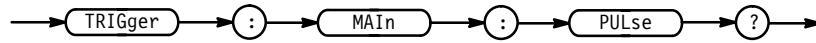

Examples TRIGGER:MAIN:PULSE?
 might return :TRIGGER:MAIN:PULSE:CLASS GLITCH;SOURCE CH1;
 GLITCH:WIDTH 2.0E-9;FILTER ACCEPT;POLARITY POSITIVE;;:TRIGGER:
 MAIN:PULSE:RUNT:POLARITY POSITIVE;THRESHOLD:HIGH 2.00E+0;LOW
 800.0E-3;:TRIGGER:MAIN:PULSE:WIDTH:LOWLIMIT 2.0E-9;HIGHLIMIT
 2.0E-9;WHEN WITHIN;POLARITY POSITIVE as the current main pulse trigger
 parameters.

TRIGger:MAIn:PULse:CLAss

TDS 5XXA, 6XXA, & 7XXA Only

Sets or queries the type of pulse to trigger on. This command is equivalent to selecting **Class** in the Trigger menu.

Group Trigger

Syntax TRIGger:MAIn:PULse:CLAss { GLItch | RUNT | WIDth |
 SLEWRate (TDS 684A & 7XXA only)}

TRIGger:MAIn:PULse:CLAss?

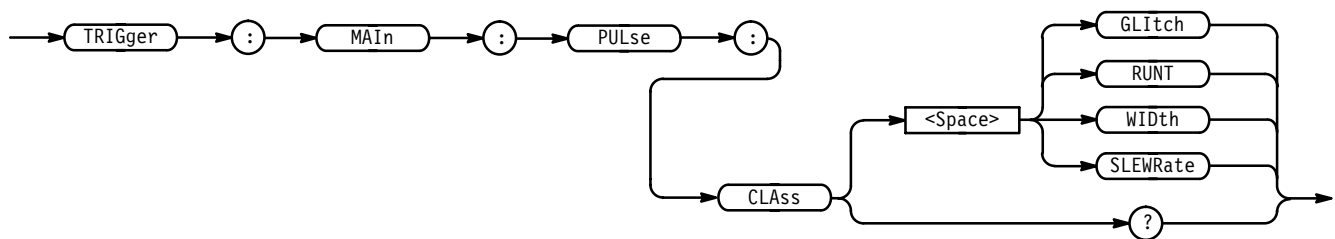

Arguments GLItch triggers when a pulse is found that is of the specified polarity and width. These are set with the commands TRIGger:MAIn:PULse:GLItch:POLarity and TRIGger:MAIn:PULse:GLItch:WIDth.

RUNT triggers when a pulse crosses the first preset voltage threshold but does not cross the second preset threshold before recrossing the first. The thresholds are set with the TRIGger:MAIn:PULse:RUNT:THReshold:LOW and TRIGger:MAIn:PULse:RUNT:THReshold:HIGH commands. The crossing can be either positive or negative as specified by TRIGger:MAIn:PULse:RUNT:POLarity.

WIDTH triggers when a pulse is found that has the specified polarity and is either inside or outside the limits as specified by TRIGGER:MAIN:PULSE:WIDTH:LOWLimit and TRIGGER:MAIN:PULSE:WIDTH:HIGHLimit. The polarity is selected using the TRIGGER:MAIN:PULSE:WIDTH:POLarity command.

SLEwrate triggers when the slew rate of the source violates the specified conditions (TDS 684A & 7XXA only).

Examples TRIGGER:MAIN:PULSE:CLASS WIDTH
specifies a width pulse for the main trigger.

TRIGGER:MAIN:PULSE:GLITCH? (Query Only)

TDS 5XXA, 6XXA, & 7XXA Only

Returns the current main glitch pulse trigger parameters.

Group Trigger

Syntax TRIGGER:MAIN:PULSE:GLITCH?

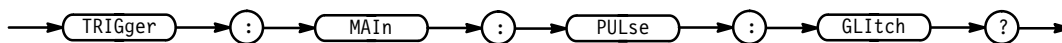

Examples TRIGGER:MAIN:PULSE:GLITCH?
might return :TRIGGER:MAIN:PULSE:CLASS GLITCH;SOURCE CH1;
GLITCH:WIDTH 2.0E-9;FILTER ACCEPT;POLARITY POSITIVE.

TRIGGER:MAIN:PULSE:GLITCH:FILTER

TDS 5XXA, 6XXA, & 7XXA Only

Controls glitch detection. This command is equivalent to selecting **Filter** in the Trigger menu.

Group Trigger

Syntax TRIGGER:MAIN:PULSE:GLITCH:FILTER { ACCEpt | REJect }
TRIGGER:MAIN:PULSE:GLITCH:FILTER?

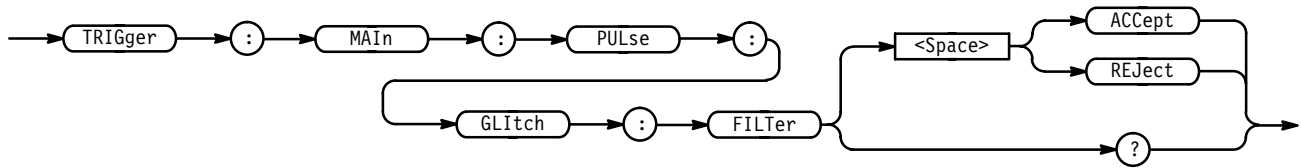

Arguments ACccept specifies that the digitizing oscilloscope will trigger only on pulses that are narrower than the specified width when the main trigger type is set to pulse glitch. The width is specified using TRIGger:MAIn:PULse:GLItch:WIDth command.

REJect specifies that the digitizing oscilloscope will trigger only on pulses that are wider than the specified width when the main trigger type is set to pulse glitch. The width is specified using TRIGger:MAIn:PULse:GLItch:WIDth command.

Examples TRIGGER:MAIN:PULSE:GLITCH:FILTER?
returns either ACccept or REJect, indicating whether glitches are filtered.

TRIGger:MAIn:PULse:GLItch:POLarity

TDS 5XXA, 6XXA, & 7XXA Only

Sets or queries the polarity for the main pulse glitch trigger. This command is equivalent to selecting **Polarity & Width** in the Trigger menu.

Group Trigger

Syntax TRIGger:MAIn:PULse:GLItch:POLarity { EITHer | NEGATive | POSITIVe }

TRIGger:MAIn:PULse:GLItch:POLarity?

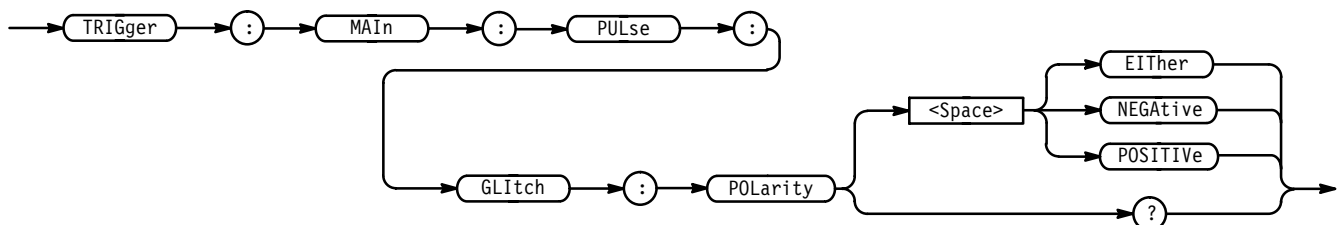

Examples TRIGGER:MAIN:PULSE:GLITCH:POLARITY EITHer
specifies that the polarity of the glitch can be either positive or negative.

TRIGger:MAIn:PULse:GLItch:WIDth

TDS 5XXA, 6XXA, & 7XXA Only

Sets or queries the width for the main pulse glitch trigger. This command is equivalent to selecting **Polarity & Width** in the Trigger menu.

Group Trigger

Syntax TRIGger:MAIn:PULse:GLItch:WIDth <NR3>
 TRIGger:MAIn:PULse:GLItch:WIDth?

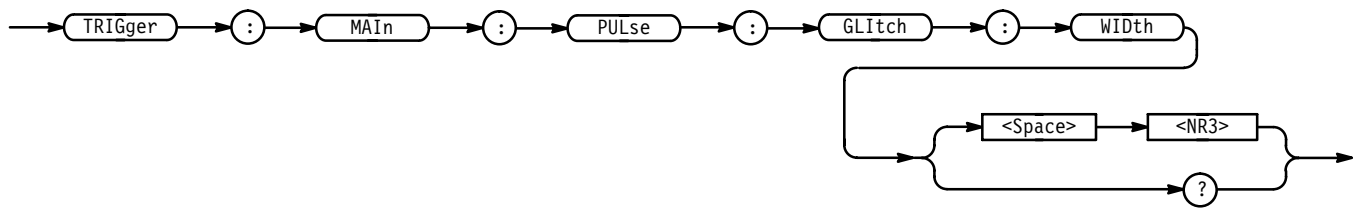

Arguments <NR3> is the width of the glitch, in seconds.

Examples TRIGGER:MAIN:PULSE:GLITCH:WIDTH 15E-6
 sets the width of the glitch to 15 μ s.

TRIGger:MAIn:PULse:RUNT? (Query Only)

TDS 5XXA, 6XXA, & 7XXA Only

Returns the current parameters for the main pulse runt trigger.

Group Trigger

Syntax TRIGger:MAIn:PULse:RUNT?

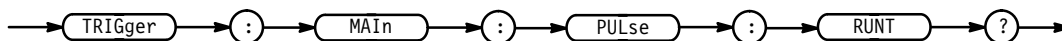

Examples TRIGGER:MAIN:PULSE:RUNT?
 might return :TRIGGER:MAIN:PULSE:RUNT:POLARITY POSITIVE;THRESH-
 OLD:HIGH 2.00E+0;LOW 800.0E-3.

TRIGger:MAIn:PULse:RUNT:POLarity

TDS 5XXA, 6XXA, & 7XXA Only

Sets or queries the polarity for the main pulse runt trigger. This command is equivalent to selecting **Polarity** in the Trigger menu.

Group Trigger

Syntax TRIGger:MAIn:PULse:RUNT:POLarity { EITHER | NEGAtive | POSITIVe }
TRIGger:MAIn:PULse:RUNT:POLarity?

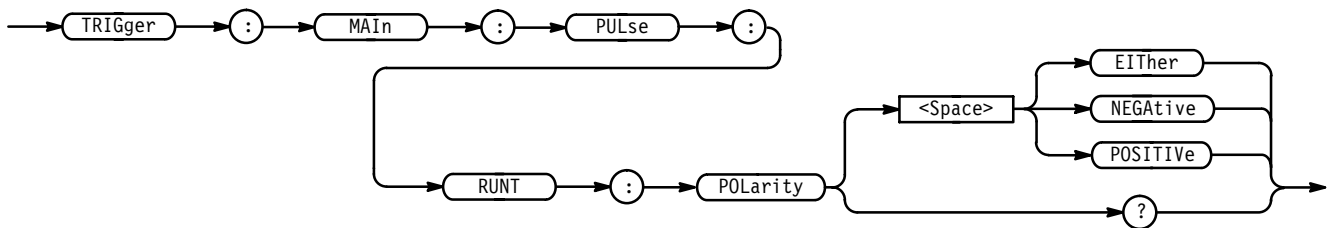

Arguments NEGAtive indicates that the falling edge crosses the high threshold and the rising edge recrosses the high threshold without either edge ever crossing the low threshold.

POSITIVe indicates that the rising edge crosses the low threshold and the falling edge recrosses the low threshold without either edge ever crossing the high threshold.

EITHer indicates either NEGAtive or POSITIVe polarity.

Examples TRIGGER:MAIN:PULSE:RUNT:POLARITY NEGATIVE
specifies that the polarity of the main pulse runt trigger is negative.

TRIGger:MAIn:PULse:RUNT:THReshold? (Query Only)

TDS 5XXA, 6XXA, & 7XXA Only

Returns the upper and lower thresholds for the main pulse runt trigger.

Group Trigger

Syntax TRIGger:MAIn:PULse:RUNT:THReshold?

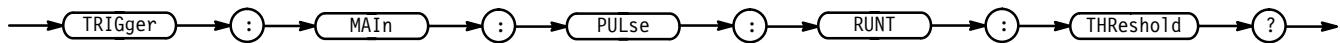

Examples TRIGGER:MAIN:PULSE:RUNT:THRESHOLD?
 might return :TRIGGER:MAIN:PULSE:RUNT:THRESHOLD:HIGH 2.00E+0;LOW 800.0E-3.

TRIGger:MAIn:PULse:RUNT:THReshold:BOTh

TDS 684A & 7XXA Only

Sets or queries the trigger level switching thresholds for the main pulse runt trigger. This command is equivalent to setting **Set to TTL** or **Set to ECL** in the Main Pulse Runt Trigger menu's **Thresholds** side menu item.

Group Trigger

Syntax TRIGger:MAIn:PULse:RUNT:THReshold:BOTh { TTL | ECL }

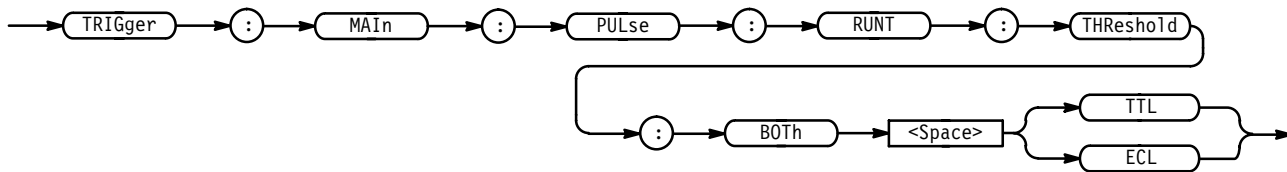

Arguments TTL sets the upper threshold to 1.8 V and the lower threshold to 0.8 V.

ECL sets the upper threshold to -1.1 V and the lower threshold to -1.5 V.

Examples TRIGGER:MAIN:PULSE:RUNT:THRESHOLD:BOTh TTL
 sets the threshold of the pulse runt trigger to the nominal TTL voltage levels.

TRIGger:MAIn:PULse:RUNT:THReshold:HIGH

TDS 5XXA 6XXA, & 7XXA Only

Sets or queries the upper limit for the main pulse runt trigger. This command is equivalent to setting the threshold in the Pulse Runt Threshold side menu.

Group Trigger

Syntax TRIGger:MAIn:PULse:RUNT:THReshold:HIGH <NR3>

TRIGger:MAIn:PULse:RUNT:THReshoId:HIGH?

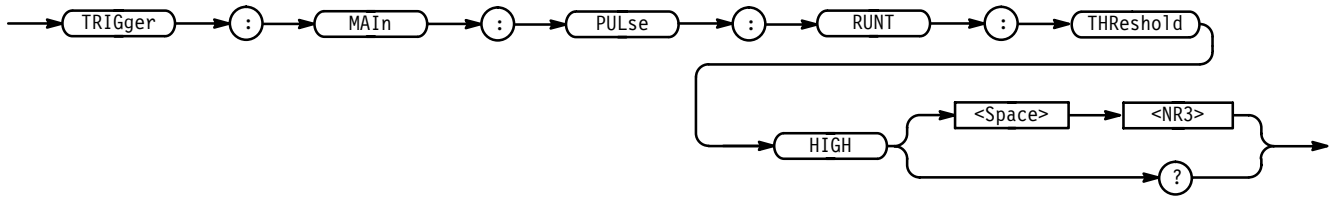

Arguments <NR3> is the threshold, in volts.

Examples TRIGGER:MAIN:PULSE:RUNT:THRESHOLD:HIGH 120E-3
sets the upper limit of the pulse runt trigger to 120 mV.

TRIGger:MAIn:PULse:RUNT:THReshoId:LOW

TDS 5XXA, 6XXA, & 7XXA Only

Sets or queries the lower limit for the main pulse runt trigger. This command is equivalent to setting the threshold in the Pulse Runt Threshold side menu.

Group Trigger

Syntax TRIGger:MAIn:PULse:RUNT:THReshoId:LOW <NR3>

TRIGger:MAIn:PULse:RUNT:THReshoId:LOW?

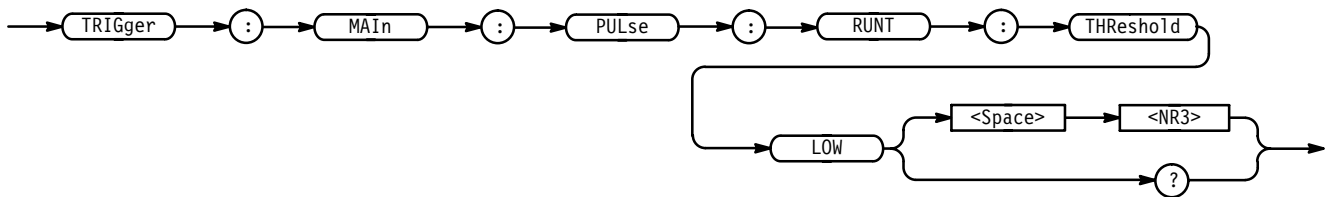

Arguments <NR3> is the threshold, in volts.

Examples TRIGGER:MAIN:PULSE:RUNT:THRESHOLD:LOW 50E-3
sets the lower limit of the pulse runt trigger to 50 mV.

TRIGger:MAIn:PULse:RUNT:WHEn

TDS 684A & 7XXA Only

Sets or queries the type of pulse width the trigger checks for when it uncovers a runt. This is equivalent to selecting **Trigger When** from the main Trigger's Pulse, Runt menu and **Occurs** or **Wider Than** in the resulting side menu.

Group Trigger

Syntax TRIGger:MAIn:PULse:RUNT:WHEn { OCCurs | WIDERthan }
 TRIGger:MAIn:PULse:RUNT:WHEn?

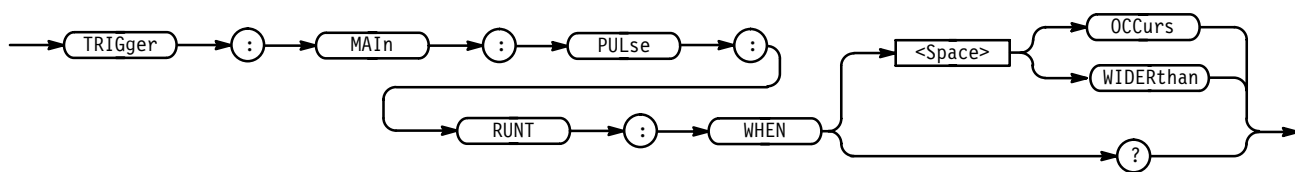

Arguments OCCurs specifies a trigger if a runt of any detectable width occurs.
 WIDERthan specifies a trigger if a runt of greater than the specified width occurs.

Examples TRIGGER:MAIN:PULSE:RUNT:WHEN WIDERTHAN
 sets the runt trigger to occur when the oscilloscope detects a runt in a pulse wider than the specified width.

TRIGger:MAIn:PULse:RUNT:WIDth

TDS 684A & 7XXA Only

Sets or queries the minimum width for a valid main pulse runt trigger. This command is equivalent to entering a value in the Trigger menu's **Wider Than** side menu.

Group Trigger

Syntax TRIGger:MAIn:PULse:RUNT:WIDth <NR3>
 TRIGger:MAIn:PULse:RUNT:WIDth?

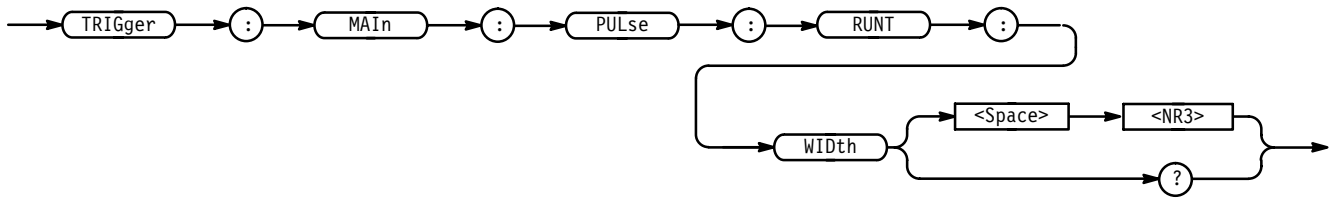

Arguments <NR3> is the minimum width in seconds.

Examples TRIGGER:MAIN:PULSE:RUNT:WIDTH 15E-6
sets the minimum width of the pulse runt trigger to 15 μ s.

TRIGger:MAIn:PULse:SLEWRate:DELTATime

TDS 684A & 7XXA Only

Sets or queries the delta time used in calculating the slew rate trigger. This is equivalent to selecting **Trigger When** from the main Trigger's Slew Rate menu and **Delta Time** in the resulting side menu.

Group Trigger

Syntax TRIGger:MAIn:PULse:SLEWRate:DELTATime <NR3>
TRIGger:MAIn:PULse:SLEWRate:DELTATime?

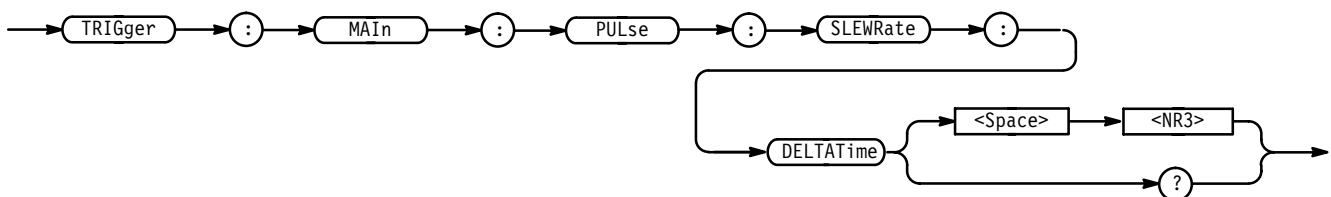

Arguments <NR3> is the delta time in seconds.

Examples TRIGGER:MAIN:PULSE:SLEWRATE:DELTATIME 15E-6
sets the slew rate trigger's delta time to 15 μ s.

TRIGger:MAIn:PULse:SLEwrate:POLarity

TDS 684A & 7XXA Only

Sets or queries the polarity for the main pulse slew rate trigger. This command is equivalent to selecting **Polarity** in the Trigger menu with **Type** set to **SlewRate**.

Group Trigger

Syntax TRIGger:MAIn:PULse:SLEwrate:POLarity { EITHER | NEGAtive | POSITIVE }

TRIGger:MAIn:PULse:SLEwrate:POLarity?

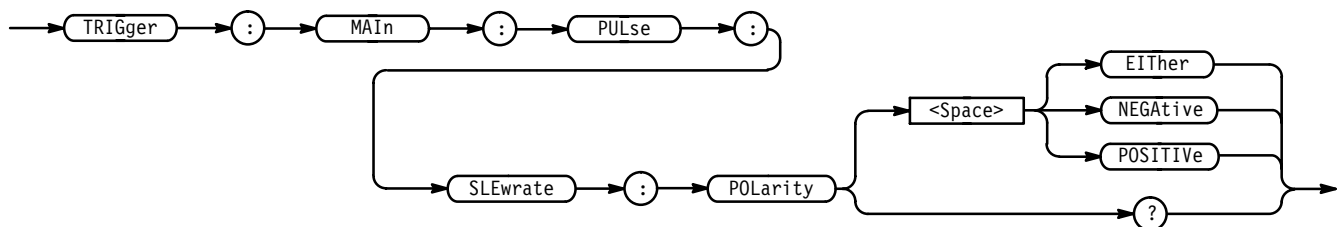

Arguments NEGAtive indicates that a pulse edge must traverse from the upper (most positive) to lower (most negative) level for slew rate triggering to occur.

POSITIVE indicates that a pulse edge must traverse from the lower (most negative) to higher (most positive) level for slew rate triggering to occur.

EITHer indicates either NEGAtive or POSITIVE polarity.

Examples TRIGGER:MAIN:PULSE:SLEwrate:POLARITY EITHER specifies that the polarity of the slew rate can be either positive or negative.

TRIGger:MAIn:PULse:SLEwrate:SLEwrate? (Query Only)

TDS 684A & 7XXA Only

Returns the slew rate value. This is the

$((Upper\ Threshold - Lower\ Threshold) / Delta\ Time)$

The value is limited to the three most significant digits.

Group Trigger

Syntax TRIGger:MAIn:PULse:SLEwrate:SLEwrate?

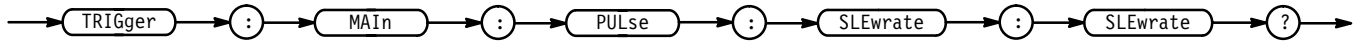

Examples TRIGGER:MAIN:PULSE:SLEWRATE:SLEWRATE?

Returns the slew rate. It is given as an appropriate amount of volts per second. For example, 1.2E+6 would represent a slew rate of 1.2 megavolts/second.

TRIGger:MAIn:PULse:SLEwrate:THReshold:BOTh

TDS 684A & 7XXA Only

Sets the upper and lower slew rate trigger thresholds. This is equivalent to selecting **Thresholds** from the main Trigger's Slew Rate menu and entering a value in the resulting side menu's **High Threshold** or **Low Threshold** items.

Group Trigger

Syntax TRIGger:MAIn:PULse:SLEwrate:THReshold:BOTh { TTL | ECL }

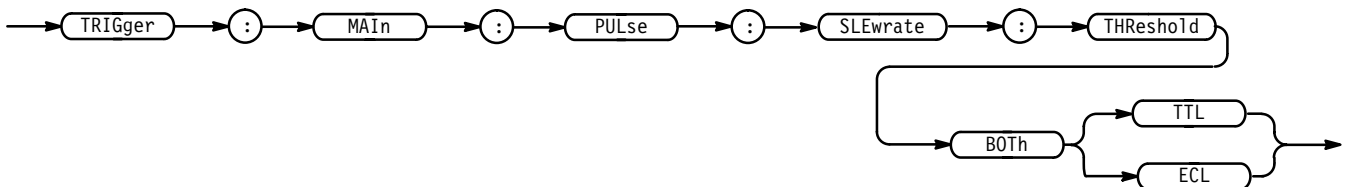

Arguments TTL sets the upper threshold to 1.8 V and the lower threshold to 0.8 V.

ECL sets the upper threshold to -1.1 V and the lower threshold to -1.5 V.

Examples TRIGGER:MAIN:PULSE:SLEWRATE:THRESHOLD:BOTh TTL
sets the trigger runt threshold to TTL.

TRIGger:MAIn:PULse:SLEwrate:THReshold:HIGH

TDS 684A & 7XXA Only

Sets or queries the upper (most positive) limit of the two threshold levels that a pulse edge must traverse for the slew rate trigger to occur. This command is equivalent to setting the higher threshold in the Pulse Slew Rate Trigger's **Thresholds** side menu item.

Group Trigger

Syntax TRIGger:MAIn:PULse:SLEwrate:THReshold:HIGH <NR3>
 TRIGger:MAIn:PULse:SLEwrate:THReshold:HIGH?

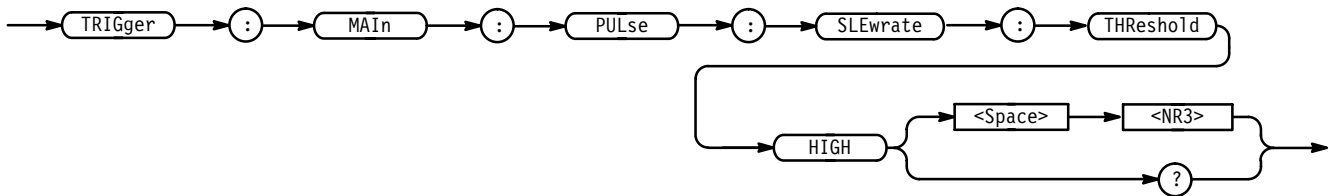

Arguments <NR3> is the threshold, in volts.

Examples TRIGGER:MAIN:PULSE:SLEWRATE:THRESHOLD:HIGH 120E-3
 sets the upper limit of the pulse slew rate trigger to 120 mV.

TRIGger:MAIn:PULse:SLEwrate:THReshold:LOW

TDS 684A & 7XXA Only

Sets or queries the lower (most negative) limit of the two threshold levels that a pulse edge must traverse for the slow rate trigger to occur. This command is equivalent to setting the lower threshold in the Pulse Slew Rate Trigger's **Thresholds** side menu item.

Group Trigger

Syntax TRIGger:MAIn:PULse:SLEwrate:THReshold:LOW <NR3>
 TRIGger:MAIn:PULse:SLEwrate:THReshold:LOW?

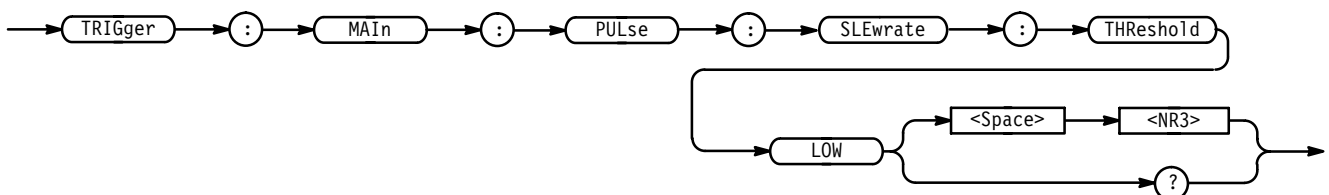

Arguments <NR3> is the threshold, in volts.

Examples TRIGGER:MAIN:PULSE:SLEWRATE:THRESHOLD:LOW 50E-3
sets the lower limit of the pulse slew rate trigger to 50 mV.

TRIGger:MAIn:PULse:SLEwrate:WHEn

TDS 684A & 7XXA Only

Sets or queries whether to check for a slewing signal that is faster or slower than the specified delta time. This is equivalent to selecting **Trigger When** from the main Trigger's Slew Rate menu and entering a value in the resulting side menu's **Trig if Less Than** or **Trig if Greater Than** items.

Group Trigger

Syntax TRIGger:MAIn:PULse:SLEwrate:WHEn { FASTERthan | SLOWERthan }
TRIGger:MAIn:PULse:SLEwrate:WHEn?

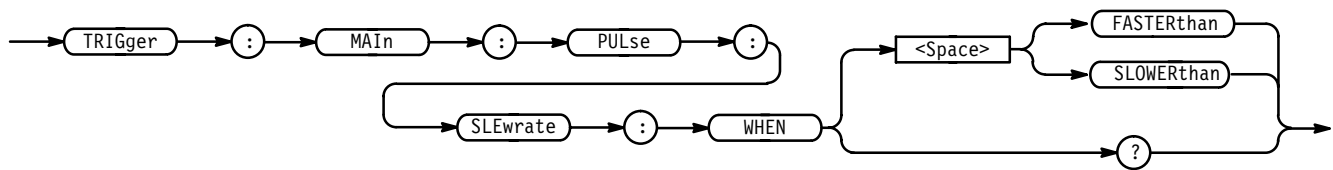

Arguments FASTERthan sets the trigger to occur when the slew is faster than the set volts/second rate.
SLOWERthan sets the trigger to occur when the slew is slower than the set volts/second rate.

Examples TRIGGER:MAIN:PULSE:SLEWRATE:WHEN FASTERTHAN
sets the slew rate trigger to work when the slew is faster than the set volts/second rate.

TRIGger:MAIn:PULse:SOUrce

TDS 5XXA, 6XXA, & 7XXA Only

Sets or queries the source for the main pulse trigger. This is equivalent to selecting the source in the Pulse Runt Source side menu.

Group Trigger

Syntax TRIGger:MAIn:PULse:SOUrce CH<x>
 TRIGger:MAIn:PULse:SOUrce?

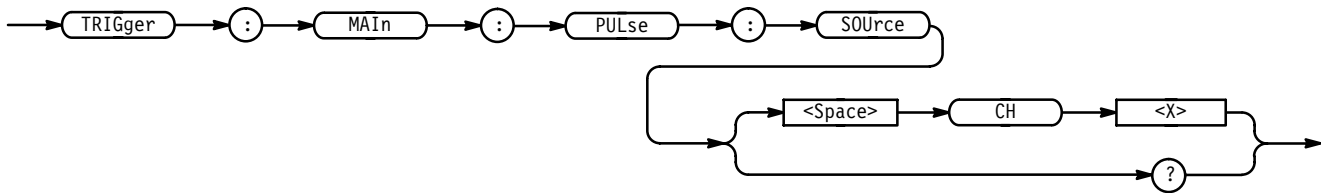

Arguments CH<x> specifies one of the input channels.

Examples TRIGGER:MAIN:PULSE:SOURCE CH2
 selects Channel 2 as the source for the main pulse trigger.

TRIGger:MAIn:PULse:WIDth? (Query Only)

TDS 5XXA, 6XXA, & 7XXA Only

Returns the width parameters for the main pulse width trigger.

Group Trigger

Syntax TRIGger:MAIn:PULse:WIDth?

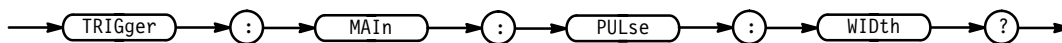

Examples TRIGGER:MAIN:PULSE:WIDTH?
 might return :TRIGGER:MAIN:PULSE:WIDTH:LOWLIMIT 2.0E-9;HIGHLIMIT 2.0E-9;WHEN WITHIN;POLARITY POSITIVE as the current main pulse trigger parameters.

TRIGger:MAIn:PULse:WIDth:HIGHLimit

TDS 5XXA, 6XXA, & 7XXA Only

Sets or queries the upper limit for the main pulse width trigger. This is equivalent to setting the **Upper Limit** in the Pulse Width Trig When side menu.

Group Trigger

Syntax TRIGger:MAIn:PULse:WIDth:HIGHLimit <NR3>

TRIGger:MAIn:PULse:WIDth:HIGHLimit?

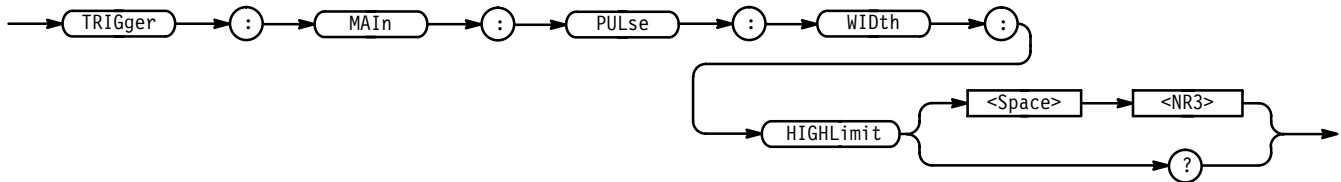

Arguments <NR3> is the upper limit, in seconds.

TRIGger:MAIn:PULse:WIDth:LOWLimit

TDS 5XXA, 6XXA, & 7XXA Only

Sets or queries the lower limit for the main pulse width trigger. This is equivalent to setting the **Lower Limit** in the Pulse Width Trig When side menu.

Group Trigger

Syntax TRIGger:MAIn:PULse:WIDth:LOWLimit <NR3>

TRIGger:MAIn:PULse:WIDth:LOWLimit?

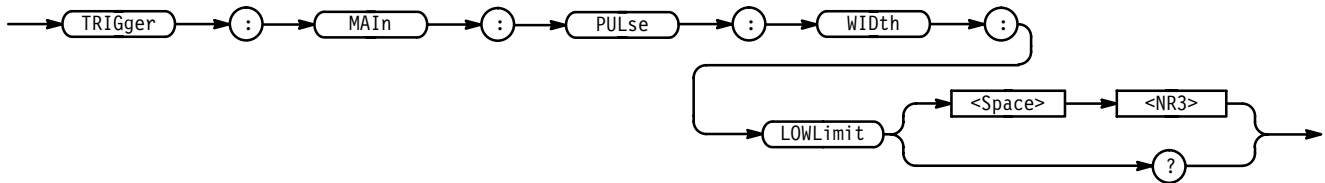

Arguments <NR3> is the lower limit, in seconds.

TRIGger:MAIn:PULse:WIDth:POLarity

TDS 5XXA, 6XXA, & 7XXA Only

Sets or queries the polarity for the main pulse width trigger. This is equivalent to selecting the polarity in the Pulse Width Polarity side menu.

Group Trigger

Syntax TRIGger:MAIn:PULse:WIDth:POLarity { NEGAtive | POSITIVE }
 TRIGger:MAIn:PULse:WIDth:POLarity?

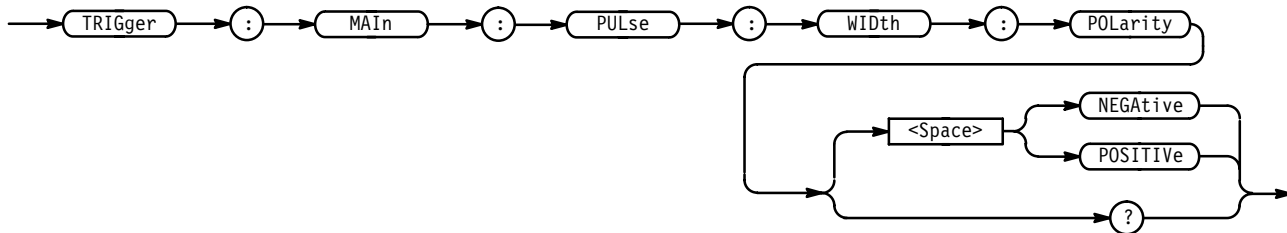

Arguments NEGAtive specifies a negative pulse.
 POSITIVE specifies a positive pulse.

TRIGger:MAIn:PULse:WIDth:WHEn

TDS 5XXA, 6XXA, & 7XXA Only

Selects the condition when the trigger occurs. This is equivalent to selecting the condition in the Pulse Width Trig When side menu.

Group Trigger

Syntax TRIGger:MAIn:PULse:WIDth:WHEn { OUTside | WIThin }
 TRIGger:MAIn:PULse:WIDth:WHEn?

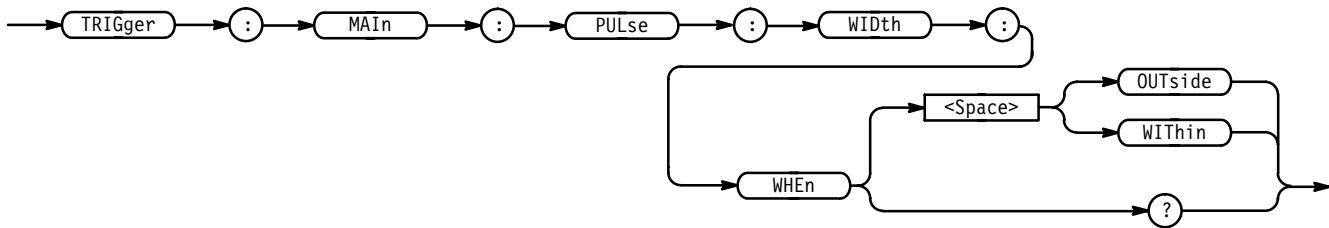

Arguments OUTside specifies a trigger when the duration of the pulse is greater than the high limit or less than the low limit specified. The high and low limits are specified with the TRIGger:MAIn:PULse:WIDth:HIGHLimit and TRIGger:MAIn:PULse:WIDth:LOWLimit commands respectively.

WIThin specifies a trigger when the duration of the pulse is within the high and low limits. The high and low limits are specified with the

TRIGger:MAIn:PULse:WIDth:HIGHLimit and TRIGger:MAIn:PULse:WIDth:LOWLimit commands respectively.

Examples TRIGGER:MAIN:PULSE:WIDTH:WHEN?
returns either OUTSIDE or WITHIN, indicating the conditions for generating a pulse trigger.

TRIGger:MAIn:TYPe

Sets or queries the type of main trigger. This is equivalent to setting **Type** in the Trigger menu.

Group Trigger

Syntax TRIGger:MAIn:TYPe { EDGE | LOGIc | PULse | VIDEo }
(Note: only the TDS 5XXA, 6XXA, & 7XXA use the LOGIc and PULse arguments. Only digitizing oscilloscopes with option 5 use the VIDEo argument.)

TRIGger:MAIn:TYPe?

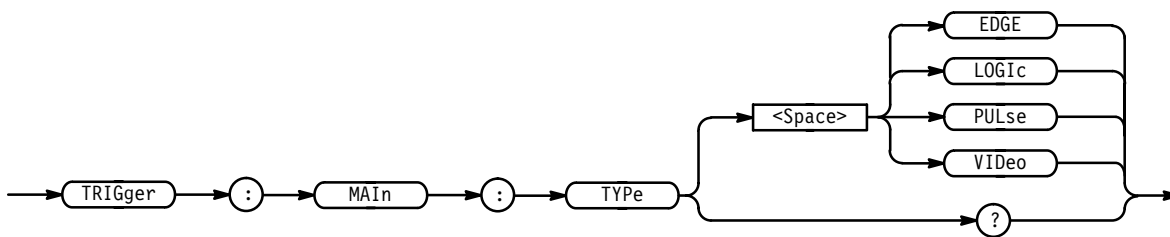

Arguments EDGE is a normal trigger. A trigger event occurs when a signal passes through a specified voltage level in a specified direction and is controlled by the TRIGger:MAIn:EDGE commands.

LOGIc (TDS 5XXA, 6XXA, & 7XXA only) specifies that a trigger occurs when specified conditions are met and is controlled by the TRIGger:MAIn:LOGIc commands.

PULse (TDS 5XXA, 6XXA, & 7XXA only) specifies that a trigger occurs when a specified pulse is found and is controlled by the TRIGger:MAIn:PULse commands.

VIDeo (option 05 only) specifies that a trigger occurs when a specified signal is found and is controlled by the TRIGger:MAIn:VIDeo commands.

Examples TRIGGER:MAIN:TYPE?
 might return PULSE indicating that the main trigger type is a pulse trigger.

TRIGger:MAIn:VIDeo? (Query Only)

Option 5 Only

Returns the main video trigger parameters.

Group Trigger

Syntax TRIGger:MAIn:VIDeo?

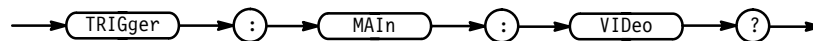

Examples TRIGGER:MAIN:VIDEO?
 might return: NTS;CH1;NEGA;NUMER;2;1;COLO;COLO;787;
 59.94E+0;1050;2;890.00E-9;3.56E-6;15.00E-6;11.56E-6;
 15.89E-6 as the current main video trigger parameters.

TRIGger:MAIn:VIDeo:BY

TDS 4XXA Option 5 Only

Sets or queries the video trigger delay mode. This is equivalent to using the Video **TV Delay Mode** side menu.

Group Trigger

Syntax TRIGger:MAIn:VIDeo:BY { TIME | LINES | LINE }

TRIGger:MAIn:VIDeo:BY?

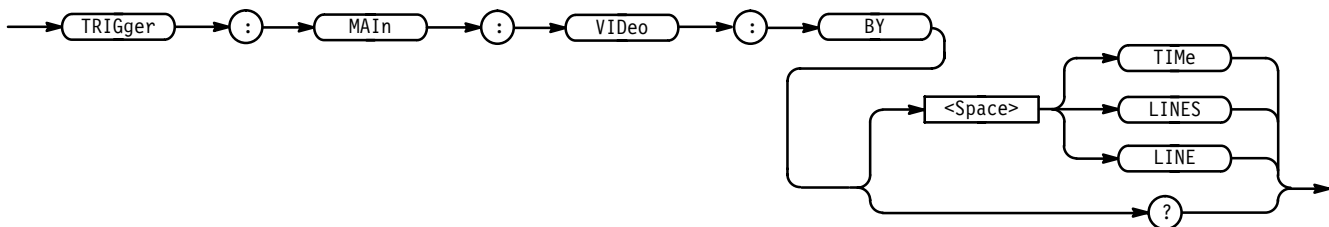

Arguments TIME specifies a delay by time.

LINES specifies a delay by a number of video lines. For the TDS 4XXA, this argument is available only for backward compatibility. If the TDS 4XXA receives this argument, it will convert it to LINE. The TDS 4XXA will not output this argument in response to a query.

LINE specifies a delay by a number of video lines.

Examples TRIGGER:MAIN:VIDEO:BY TIME
specifies a delay by time.

TRIGger:MAIn:VIDeo:FIELD

TDS 4XXA Option 5 Only

Sets or queries the field the video trigger acts on. This is equivalent to using the Video **Scan** side menu when **Class** is NOT set to **Custom**.

Group Trigger

Syntax TRIGger:MAIn:VIDeo:FIELD { ODD | EVEN | ALL | FIELD1 | FIELD2 | FIELDEither }

TRIGger:MAIn:VIDeo:FIELD?

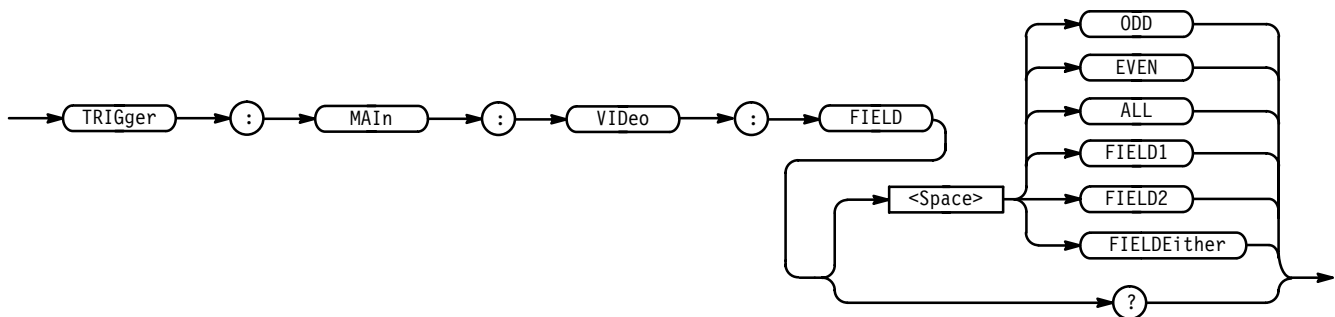

Arguments ODD specifies interlaced video field 1.

EVEN specifies interlaced video field 2.

ALL specifies alternating both video field 1 and video field 2.

FIELD1 specifies interlaced video field 1. For the TDS 4XXA, this argument is available only for backward compatibility. If the TDS 4XXA receives this

argument, it will convert it to ODD. The TDS 4XXA will not output this argument in response to a query.

FIELD2 specifies interlaced video field 2. For the TDS 4XXA, this argument is available only for backward compatibility. If the TDS 4XXA receives this argument, it will convert it to EVEN. The TDS 4XXA will not output this argument in response to a query.

FIELDEither specifies alternating both video field 1 and video field 2. For the TDS 4XXA, this argument is available only for backward compatibility. If the TDS 4XXA receives this argument, it will convert it to ALL. The TDS 4XXA will not output this argument in response to a query.

Examples TRIGGER:MAIN:VIDEO:SCAN ODD
selects odd fields.

TRIGger:MAIn:VIDeo:FIELD

TDS 5XXA, 6XXA, & 7XXA Option 5 Only

Sets or queries the field the video trigger acts on. This is equivalent to pressing **Field** in the video main menu, then **Field** in the side menu, and entering a value with the keypad or general purpose knob.

Group Trigger

Syntax TRIGger:MAIn:VIDeo:FIELD <NR1>
TRIGger:MAIn:VIDeo:FIELD?

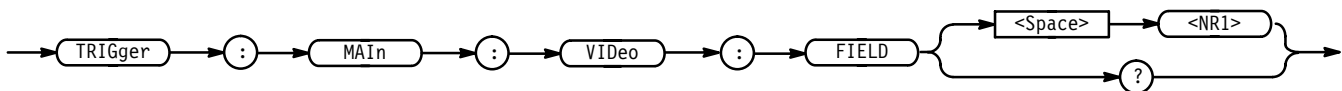

Arguments <NR1> specifies the video (color) field. For example, 1 specifies interlaced video field one and 2 specifies interlaced video field two.

PAL signals have 1 to 8 fields, HDTV signals have 1 or 2, and FlexFormat supports 1 or 2.

Examples TRIGGER:MAIN:VIDEO:FIELD 1
selects field 1.

TRIGger:MAIn:VIDeo:FIELDType

TDS 5XXA, 6XXA, & 7XXA Option 5 Only

Sets or queries the field the video trigger acts on. This is equivalent to pressing **Field** in the video main menu and then **Field**, **Odd**, **Even** or **All** in the side menu.

Group Trigger

Syntax TRIGger:MAIn:VIDeo:FIELDType { NUMERic | ALL | EVEN | ODD }
TRIGger:MAIn:VIDeo:FIELDType?

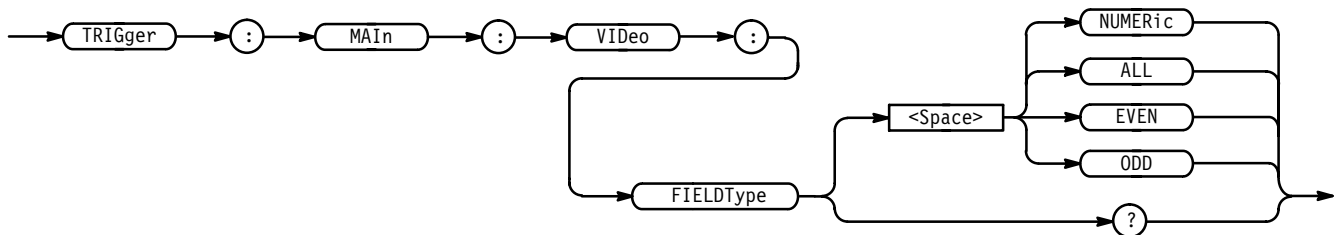

Arguments NUMERic specifies a selected line in the selected field. If you send this command when the mode is MONO or SECAM, the digitizing oscilloscope will generate an SRQ.

ALL specifies a selected line in all fields.

EVEN specifies a selected line in even fields.

ODD specifies a selected line in odd fields.

Examples TRIGGER:MAIN:VIDEO:FIELDTYPE ALL
selects a selected line in all fields.

TRIGger:MAIn:VIDeo:FLEXformat? (Query Only)

TDS 5XXA, 6XXA, & 7XXA Option 5 Only

Returns the main flexible-format video trigger parameters.

Group Trigger

Syntax TRIGger:MAIn:VIDeo:FLEXformat?

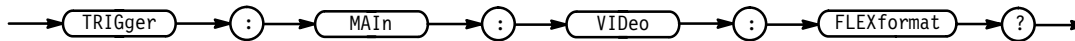

Examples TRIGGER:MAIN:VIDEO:FLEXFORMAT?
 might return: 59.94E+0;1050;2;890.0E-9;3.56E-6;15.00E-6;11.56E-6;
 15.89E-6 as the flexible-format video trigger parameters.

TRIGger:MAIn:VIDEo:FLEXformat:FIELDRATE

TDS 5XXA, 6XXA, & 7XXA Option 5 Only

Sets or queries the flexible-format video frames per second (e.g. 59.94 frames per second for 1050 and 50 for 1250). This is equivalent to selecting **Setup** from the video main menu (with **FlexFmt** as the **Standard**), **Field Rate** from the side menu, and entering a value with the keypad or the general purpose knob.

Group Trigger

Syntax TRIGger:MAIn:VIDEo:FLEXformat:FIELDRATE <NR3>
 TRIGger:MAIn:VIDEo:FLEXformat:FIELDRATE?

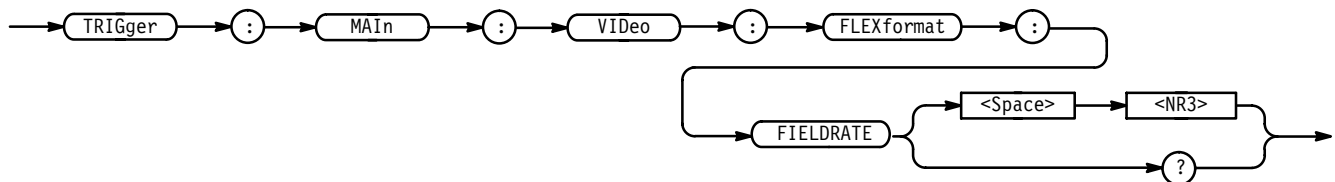

Arguments <NR3> the field rate.

Examples TRIGGER:MAIN:VIDEO:FLEXFORMAT:FIELDRATE?
 returns the specified field rate.

TRIGger:MAIn:VIDEo:FLEXformat:FIELDS

TDS 5XXA, 6XXA, & 7XXA Option 5 Only

Sets or queries the flexible-format video fields. This is equivalent to pressing **Setup** from the video main menu (with **FlexFmt** as the **Standard**), **Fields** from the side menu, and entering the value with the keypad or the general purpose knob.

Group Trigger

Syntax TRIGger:MAIn:VIDeo:FLEXformat:FIELDs <NR1>
TRIGger:MAIn:VIDeo:FLEXformat:FIELDs?

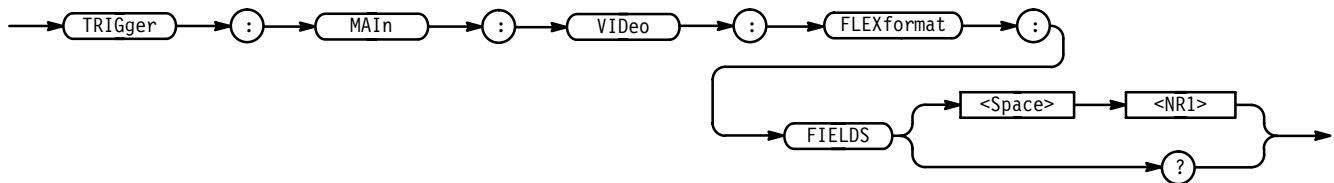

Arguments <NR1> the number of fields in the standard.

Examples TRIGGER:MAIN:VIDEO:FLEXformat:FIELD?
returns the number of fields in the format.

TRIGger:MAIn:VIDeo:FLEXformat:LINES

TDS 5XXA, 6XXA, & 7XXA Option 5 Only

Sets or queries the flexible-format video lines in a frame. This is equivalent to pressing **Setup** from the video main menu (with **FlexFmt** as the **Standard**), **Lines** from the side menu, and entering the value with the keypad or the general purpose knob.

Group Trigger

Syntax TRIGger:MAIn:VIDeo:FLEXformat:LINES <NR3>
TRIGger:MAIn:VIDeo:FLEXformat:LINES?

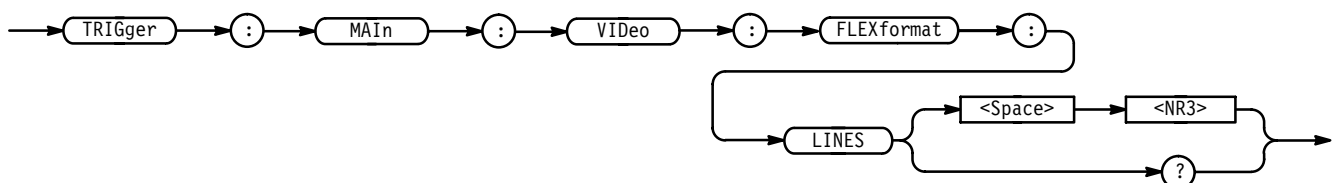

Arguments <NR3> the frame lines.

Examples TRIGGER:MAIN:VIDEO:FLEXFORMAT:LINES?
 returns the specified number of lines.

TRIGger:MAIn:VIDeo:FLEXformat:NEGSyncwidth

TDS 5XXA, 6XXA, & 7XXA Option 5 Only

Sets or queries the flexible-format negative sync width. The HDTV horizontal sync is a tri-level sync. The first of the two consecutive sync pulses used is negative and the second is positive. The positive sync pulse starts on the rising edge of the negative sync. The two pulses have the same width such that specifying the negative pulse is only required. Setting the width is equivalent to pressing **Setup** from the video main menu (with **FlexFmt** as the **Standard**), **Sync Width** from the side menu, and entering the value with the keypad or the general purpose knob.

Group Trigger

Syntax TRIGger:MAIn:VIDeo:FLEXformat:NEGSyncwidth <NR3>
 TRIGger:MAIn:VIDeo:FLEXformat:NEGSyncwidth?

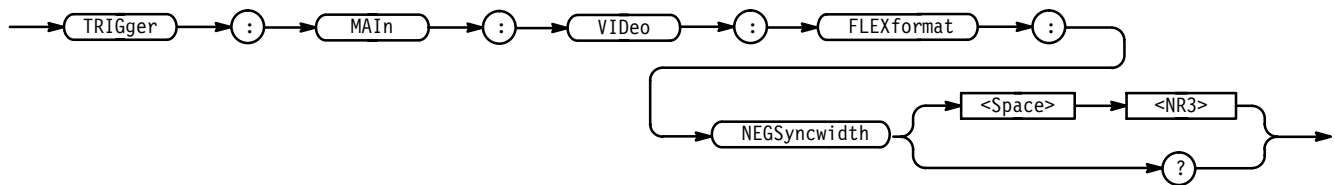

Arguments <NR3> the negative sync width.

Examples TRIGGER:MAIN:VIDEO:FLEXFORMAT:NEGSYNCWIDTH?
 returns the specified flexible-format negative sync width.

TRIGger:MAIn:VIDeo:FLEXformat:V1STArtime

TDS 5XXA, 6XXA, & 7XXA Option 5 Only

Sets or queries the time from the positive edge of the tri-sync pulse for the last line in the selected field (t_0) to the leading edge (negative) of the first negative vertical sync pulse. This is equivalent to selecting **Setup** from the video main menu (with **FlexFmt** as the **Standard**), pressing the **V1 Start Time** in the side menu, and entering a value with the keypad or the general purpose knob.

Group Trigger

Syntax TRIGger:MAIn:VIDeo:FLEXformat:V1StArttime <NR3>
TRIGger:MAIn:VIDeo:FLEXformat:V1StArttime?

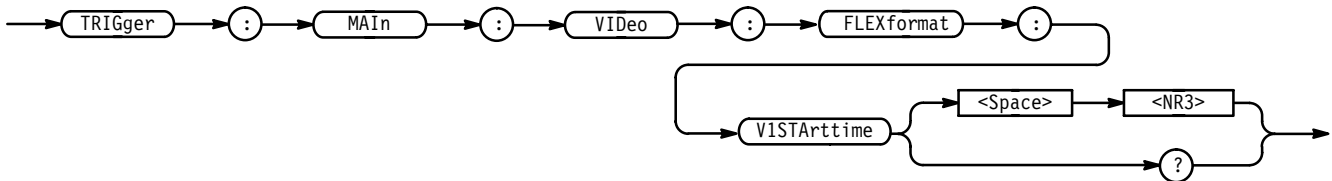

Arguments <NR3> the v1 starttime.

Examples TRIGGER:MAIN:VIDEO:FLEXFORMAT:V1STARTTIME?
returns the specified HDTV v1starttime.

TRIGger:MAIn:VIDeo:FLEXformat:V1StOptime

TDS 5XXA, 6XXA, & 7XXA Option 5 Only

Sets or queries the time from t_0 to the trailing edge (positive) of the first negative vertical sync pulse. This is equivalent selecting **Setup** from the video main menu (with **FlexFmt** as the **Standard**), pressing the **V1 Stop Time** in the side menu, and entering a value with the keypad or the general purpose knob.

Group Trigger

Syntax TRIGger:MAIn:VIDeo:FLEXformat:V1StOptime <NR3>
TRIGger:MAIn:VIDeo:FLEXformat:V1StOptime?

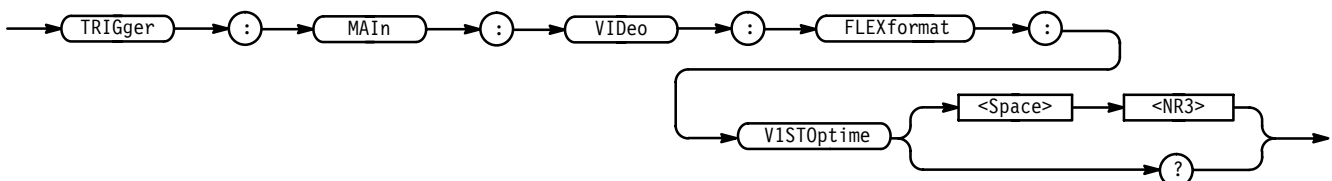

Arguments <NR3> the v1 stoptime.

Examples TRIGGER:MAIN:VIDEO:FLEXFORMAT:V1STOPTIME?
 returns the specified v1stoptime.

TRIGger:MAIn:VIDeo:FLEXformat:V2STArttime

TDS 5XXA, 6XXA, & 7XXA Option 5 Only

Sets or queries the time from the positive edge of the tri-sync pulse for the last line in the selected field (t_0) to the leading edge (positive) of the second vertical sync pulse. Note: the second pulse may be a negative pulse or the negative portion of a tri-sync pulse that is within the last line (usually located at the $\frac{1}{2}$ line point). This is equivalent to selecting **Setup** from the video main menu (with **FlexFmt** as the **Standard**), pressing the **V2 Start Time** in the side menu, and entering a value with the keypad or the general purpose knob.

Group Trigger

Syntax TRIGger:MAIn:VIDeo:FLEXformat:V2STArttime <NR3>
 TRIGger:MAIn:VIDeo:FLEXformat:V2STArttime?

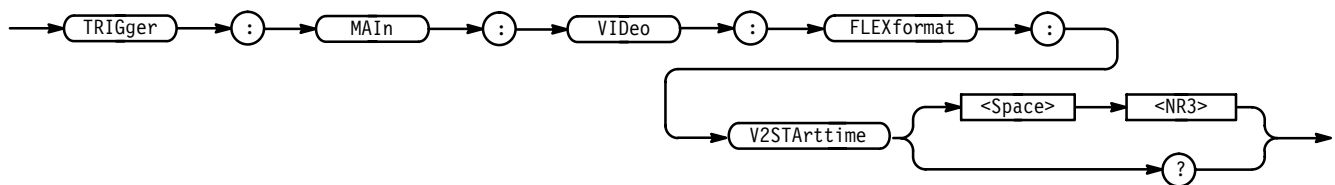

Arguments <NR3> the v2 starttime.

Examples TRIGGER:MAIN:VIDEO:FLEXFORMAT:V2STARTTIME?
 returns the specified v2 starttime.

TRIGger:MAIn:VIDeo:FLEXformat:V2STOptime

TDS 5XXA, 6XXA, & 7XXA Option 5 Only

Sets or queries the time from t_0 to the trailing edge (positive) of the second negative vertical sync pulse. This is equivalent selecting **Setup** from the video main menu (with **FlexFmt** as the **Standard**), pressing the **V2 Stop Time** in the side menu, and entering a value with the keypad or the general purpose knob.

Group Trigger

Syntax TRIGger:MAIn:VIDeo:FLEXformat:V2STOptime <NR3>
 TRIGger:MAIn:VIDeo:FLEXformat:V2STOptime?

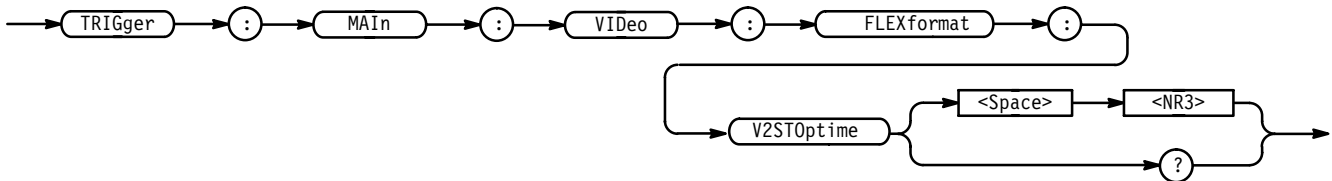

Arguments <NR3> the v2 stoptime.

Examples TRIGGER:MAIN:VIDEO:FLEXFORMAT:V2STOPTIME?
 returns the specified v2 stoptime.

TRIGger:MAIn:VIDeo:HDTv

TDS 5XXA, 6XXA, & 7XXA Option 5 Only

Sets or queries the high definition TV frame rate. This is equivalent to toggling **HDTV** from the Video main-menu **Standard** pop-up, pressing **Format**, and then selecting a frame rate from the side menu.

Group Trigger

Syntax TRIGger:MAIn:VIDeo:HDTv <NR1>
 TRIGger:MAIn:VIDeo:HDTv?

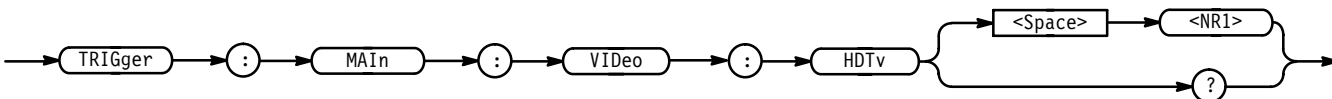

Arguments <NR1> specifies the frame rate. More precisely, 787 selects a 787/59.94/2:1 format. 1050 selects a 1050/59.94/2:1 format. 1125 selects a 1125/60/2:1 format. 1250 selects a 1250/50/2:1 format.

Examples TRIGGER:MAIN:VIDEO:HDTV 787
specifies 787/59.94/2:1 format.

TRIGger:MAIn:VIDeo:HOLdoff? (Query Only)

TDS 4XXA Option 5 Only

Returns the video trigger holdoff value.

Group Trigger

Syntax TRIGger:MAIn:VIDeo:HOLdoff?

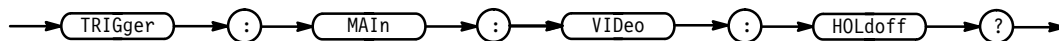

Examples TRIGGER:MAIN:VIDEO:HOLDOFF?
might return :TRIGGER:MAIN:VIDEO:HOLDOFF:VALUE 0.

TRIGger:MAIn:VIDeo:HOLdoff:VALue

TDS 4XXA Option 5 Only

Sets or queries the video trigger holdoff value. This is equivalent to setting **Holdoff** in the Mode & Holdoff side menu of the video trigger menu.

Group Trigger

Syntax TRIGger:MAIn:VIDeo:HOLdoff:VALue <NR1>

TRIGger:MAIn:VIDeo:HOLdoff:VALue?

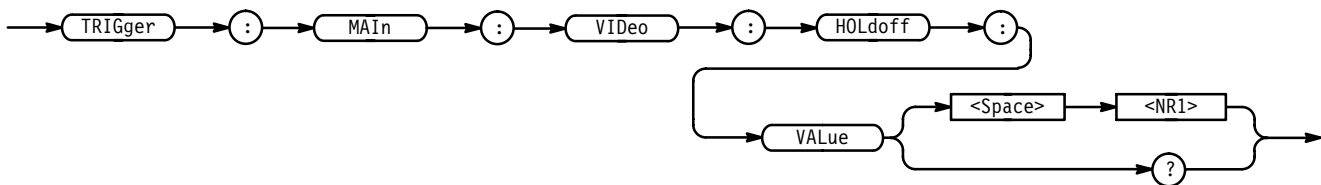

Arguments <NR1> is from 0 to 100, and is a percent of the holdoff range.

Examples TRIGGER:MAIN:HOLDOFF:VALUE 10
set the holdoff value to be 10% of the holdoff range.

TRIGger:MAIn:VIDeo:INTERLAcE

TDS 4XXA Option 5 Only

Sets or queries the video trigger interlace format. This is equivalent to setting **Interlace** in the **Scan Rate and Interlace** main menu of the video trigger menu when **Class** is set to **Custom**.

Group Trigger

Syntax TRIGger:MAIn:VIDeo:INTERLAcE { FIELD1 | FIELD2 | FIELDEither | OFF }

TRIGger:MAIN:VIDeo:INTERLAcE?

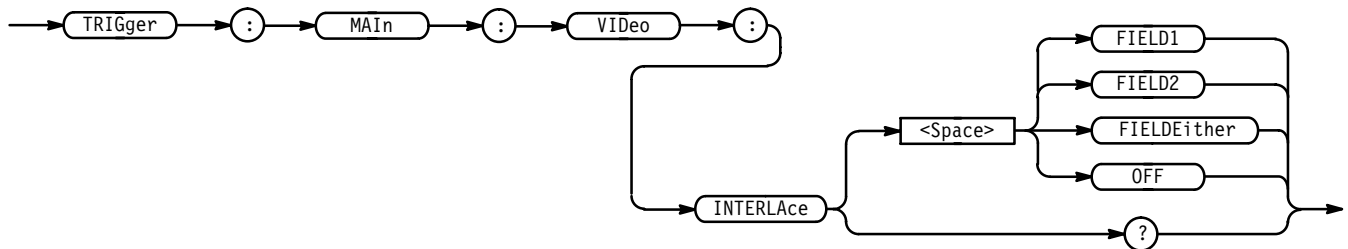

TRIGger:MAIn:VIDeo:LINE

Option 5 Only

Sets or queries the video trigger in terms of a number of lines. This is equivalent to pressing the **Line (TV Delay Mode)** in the TDS 4XXA) item in the video main menu, pressing **Line** in the side menu (if needed), and entering a value with the keypad or the general purpose knob. The minimum line number is the starting line in the field. For PAL, field 1 (odd fields in the TDS 4XXA) has line 2 (1 in the TDS 4XXA) as the minimum, and field 2 (even fields in the TDS 4XXA) has line 315 (314 in the TDS 4XXA).

Group Trigger

Syntax TRIGger:MAIn:VIDeo:LINE <NR1>

TRIGger:MAIn:VIDeo:LINE?

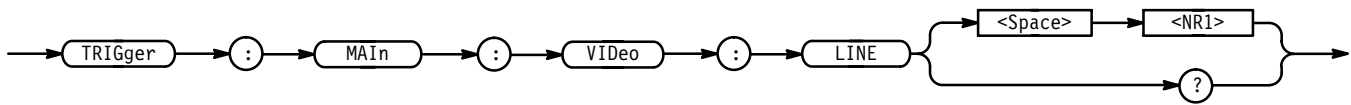

Arguments <NR1> specifies a number of lines to delay by.

Examples TRIGGER:MAIN:VIDEO:LINE 5
selects 5 lines for the desired delay period.

TRIGGER:MAIN:VIDEO:LINES

TDS 4XXA Option 5 Only

Sets or queries the video trigger delay in terms of a number of lines. This is equivalent to entering data in the **Line** item in the Video **TV Delay Mode** side menu. This command is available for backwards compatibility.

Group Trigger

Syntax TRIGGER:MAIN:VIDEO:LINES <NR3>
TRIGGER:MAIN:VIDEO:LINES?

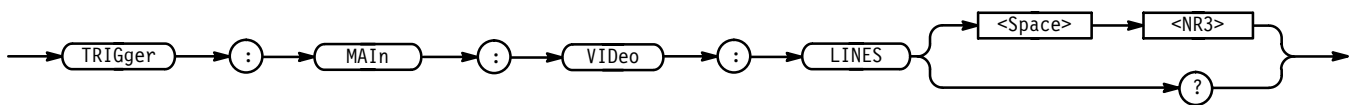

Arguments <nr3> specifies a number of lines to delay by.

Examples TRIGGER:MAIN:VIDEO:LINES 5
selects 5 lines for the desired delay period.

TRIGGER:MAIN:VIDEO:NTSC

TDS 5XXA, 6XXA, & 7XXA Option 5 Only

Sets or queries the NTSC mode selection. This is equivalent to choosing **525/NTSC** in the video main-menu pop-up, **Mode** in the main menu, and a side menu item (**NTSC** or **Mono**).

Group Trigger

Syntax TRIGger:MAIn:VIDeo:NTSc { MONo | COLOr }

TRIGger:MAIn:VIDeo:NTSc?

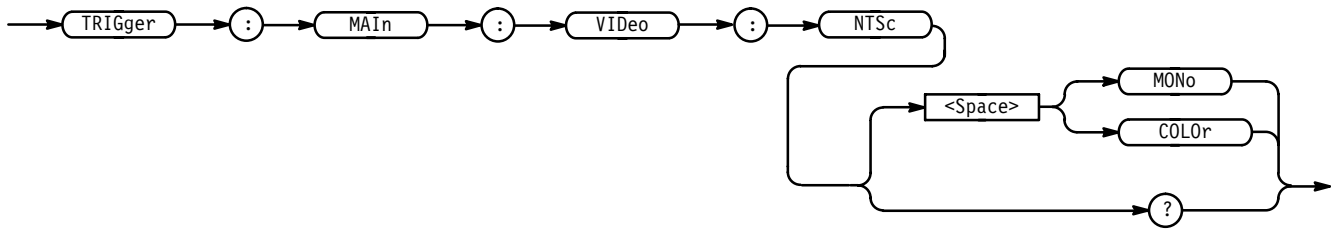

Arguments MONo specifies mode for noncolor signals.

COLOr specifies mode for color field triggering and enables numeric triggering.

Examples TRIGGER:MAIN:VIDEO:NTSC MONO
specifies numeric fields are invalid.

TRIGger:MAIn:VIDeo:PAL

TDS 5XXA, 6XXA, & 7XXA Option 5 Only

Sets or queries the PAL video trigger mode selection. This is equivalent to toggling **625/PAL** in the video main-menu pop-up, **Mode** in the main menu, and a side menu item (**PAL**, **Mono**, or **SECAM**).

Group Trigger

Syntax TRIGger:MAIn:VIDeo:PAL { MONo | COLOr | SECAm }

TRIGger:MAIn:VIDeo:PAL?

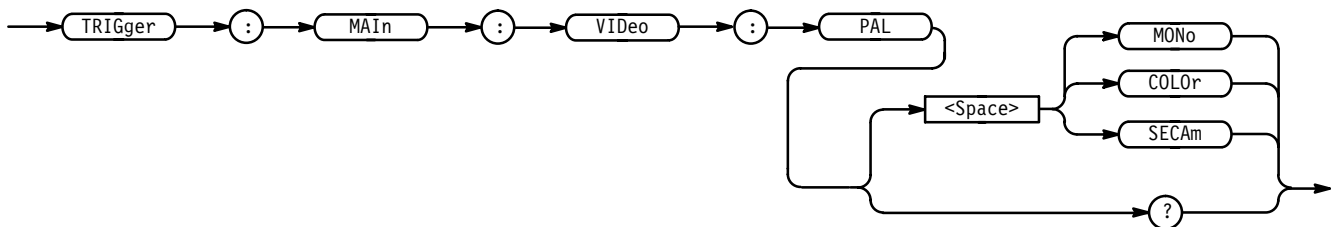

Arguments MONo specifies mode for non-color signals.

COLOr specifies mode for color field triggering and enables numeric triggering.

SECAm specifies mode for SECAM signals.

Examples TRIGGER:MAIN:VIDEO:PAL MONO
specifies non-color PAL signals.

TRIGger:MAIn:VIDeo:SCAN

TDS 4XXA Option 5 Only

Sets or queries the video trigger scan parameters. This is equivalent to using the Video **Scan Parameters** side menu.

Group Trigger

Syntax TRIGger:MAIn:VIDeo:SCAN { RATE1 | RATE2 | RATE3 | RATE4 }
TRIGger:MAIn:VIDeo:SCAN?

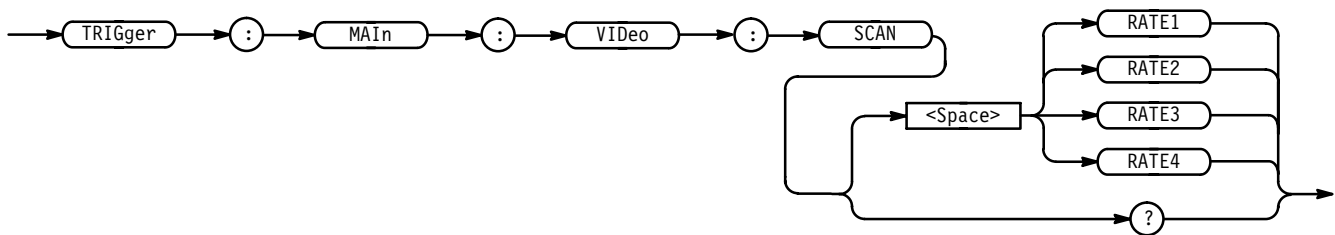

Arguments RATE1 specifies a 15 to 20 kHz video line rate.
RATE2 specifies a 20 to 25 kHz video line rate.
RATE3 specifies a 25 to 35 kHz video line rate.
RATE4 specifies a 35 to 64 kHz video line rate.

Examples TRIGGER:MAIN:VIDEO:SCAN RATE1
selects rate 1.

TRIGger:MAIn:VIDeo:SCANPeriod

TDS 4XXA Option 5 Only

Sets or queries the video trigger scan period.

Group	Trigger
Syntax	TRIGger:MAIn:VIDeo:SCANPeriod <NR3> TRIGger:MAIn:VIDeo:SCANPeriod?

TRIGger:MAIn:VIDeo:SOURce

Option 05 Only

Sets or queries the source for the main video trigger. This is equivalent to selecting the **Source** in the video main menu and a desired channel from the side menu.

Group	Trigger
Syntax	TRIGger:MAIn:VIDeo:SOURce CH<x> TRIGger:MAIn:VIDeo:SOURce?

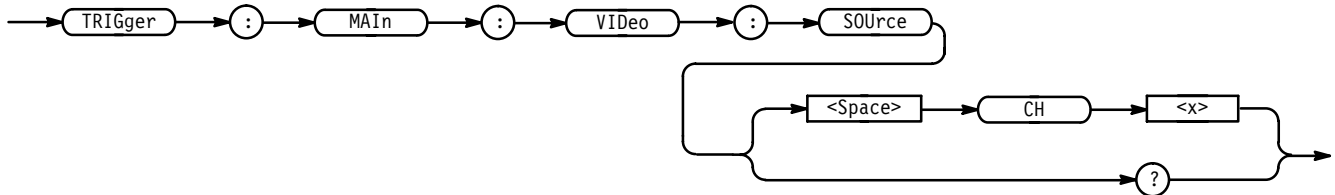

Arguments CH<x> specifies one of the input channels (CH1, CH2, CH3, or CH4; or CH1, CH2, AUX1, or AUX2 on the TDS 520A, 524A, & 620A).

Examples TRIGGER:MAIN:VIDEO:SOURCE CH1
selects channel 1 as the source for the main video trigger.

TRIGger:MAIn:VIDeo:STANdard

TDS 5XXA, 6XXA, & 7XXA Option 5 Only

Sets or queries the video trigger standard. This is equivalent to selecting the standard in the video **Standard** pop-up (**525/NTSC**, **625/PAL**, **HDTV**, or **FlexFmt**).

Group	Trigger
--------------	---------

Syntax TRIGger:MAIn:VIDeo:STANdard { NTSc | PAL | HDTv | FLEXformat }
 TRIGger:MAIn:VIDeo:STANdard?

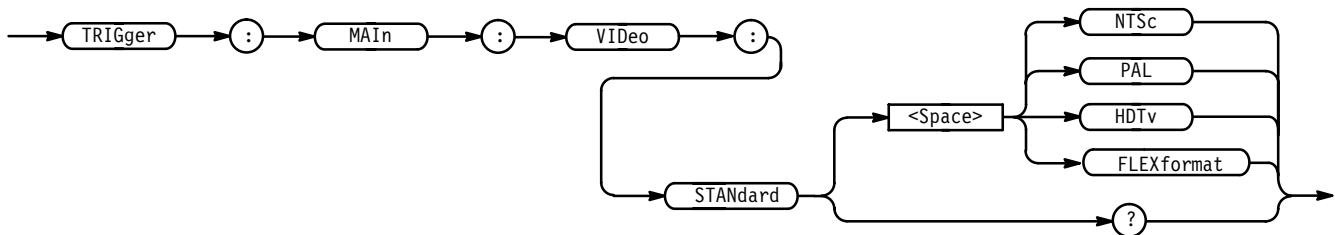

Arguments NTSc specifies the NTSC 525/59.94/2:1 standard.
 PAL specifies the PAL 625/59.94/2:1 standard.
 HDTv allows selection of the following HDTV formats: 787/59.94/1:1, 1050/59.94/2:1, 1050/59.94/2:1, 1125/60/2:1, 1250/50/2:1.
 FLEXformat allows the user to specify the video parameters. The default table is 1050/59.94/2:1.

Examples TRIGGER:MAIN:VIDEO:STANDARD NTSC
 selects the NTSC video format.

TRIGger:MAIn:VIDeo:SYNc

Option 05 Only

Sets or queries the video trigger sync polarity. This is equivalent to selecting **Sync Polarity** from the video main menu and a side-menu item (**Neg Sync** or **Pos Sync**).

Group Trigger

Syntax TRIGger:MAIn:VIDeo:SYNc { POSITIVe | NEGATIVe }
 TRIGger:MAIn:VIDeo:SYNc?

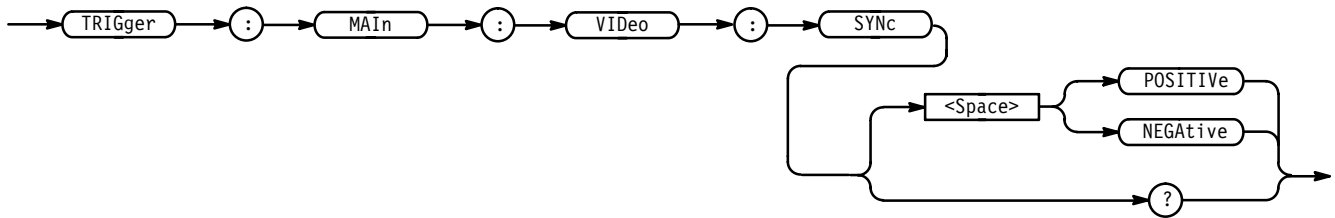

Arguments POSITIVE specifies a positive going voltage.
 NEGAtive specifies a negative going voltage.

Examples TRIGGER:MAIN:VIDEO:SYNC POSITIVE
 selects a positive going voltage for the desired synchronization pulse.

TRIGGER:MAIN:VIDEO:SYSTEM

TDS 4XXA Option 5 Only

Sets or queries the video trigger class. This is equivalent to selecting the class in the **Video Class** side menu of the Video menu.

Group Trigger

Syntax TRIGGER:MAIN:VIDEO:SYSTEM { NTSc | PAL | SECAM | CUSTom }
 TRIGGER:MAIN:VIDEO:SYSTEM?

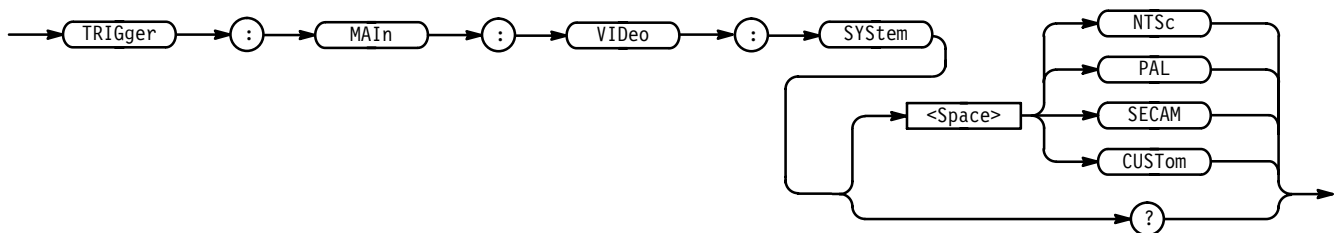

Arguments NTSc selects a condition that adheres to the National Television System Committee standards. Specifically, it assumes a line rate of 525 lines per frame and a frame rate of 30 Hz.

PAL selects a condition that adheres to the Phase Alternate Line standard. Specifically, it assumes a line rate of 625 lines per frame and a frame rate of 25 Hz.

SECAM selects a condition that adheres to the SECAM standard.

CUSTOM selects a condition that adheres to the frequency range of the video signal as you have defined them from the available ranges.

Examples TRIGGER:MAIN:SYSTEM NTSC
 selects triggering to occur on an NTSC compatible signal.

TRIGger:MAIn:VIDeo:TIME

TDS 4XXA Option 5 Only

Sets or queries the video trigger delay time. This is equivalent to entering the time in the **Delay by Time** item of the Video **TV Delay Mode** side menu.

Group Trigger

Syntax TRIGger:MAIn:VIDeo:TIME <NR3>
 TRIGger:MAIn:VIDeo:TIME?

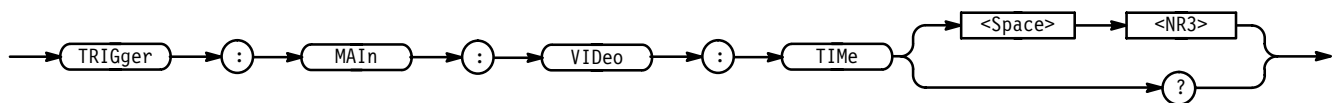

Arguments <NR3> specifies a delay time.

Examples TRIGGER:MAIN:VIDEO:TIME 5E-6
 selects 5 μ s for the desired delay time.

TRIGger:STATE? (Query Only)

Returns the current state of the triggering system.

Group Trigger

Syntax TRIGger:STATE?

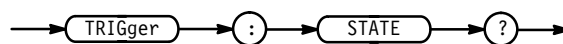

Returns **ARMed** indicates that the instrument is acquiring pretrigger information. All triggers are ignored when **TRIGger:STATE** is **ARMING**.

AUTO indicates that the digitizing oscilloscope is in auto mode and acquires data even in the absence of a trigger.

FASTframe (TDS 5XXA and 7XXA only) indicates that the instrument is in FastFrame mode. This means normal trigger status monitoring is turned off. The digitizing oscilloscope will not return armed, partial, ready, trigger, or auto while in this state.

INStavu (TDS 7XXA only) indicates that the instrument is in InstaVu mode.

PARTial indicates that the main trigger has occurred and the digitizing oscilloscope is waiting for trigger(s) for the delay by events.

REAdy indicates that all pretrigger information has been acquired and the digitizing oscilloscope is ready to accept a trigger.

SAVe indicates that the digitizing oscilloscope is in save mode and is not acquiring data.

TRIGger indicates that the digitizing oscilloscope has seen a trigger and is acquiring the posttrigger information.

Examples **TRIGGER:STATE?**
might return **ARMED**, indicating that pretrigger data is being acquired.

*TRG (No Query Form)

(Trigger) executes commands that are defined by *DDT.

The Group Execute Trigger (GET) interface message has the same effect as the *TRG command.

Group Miscellaneous

Related Commands Alias commands, *DDT

Syntax *TRG

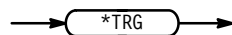

Examples *TRG
 immediately executes all commands that have been defined by *DDT.

*TST? (Query Only)

(Self-Test) Tests the GPIB interface and returns a 0.

Group Miscellaneous

Syntax *TST?



Returns <NR1> and is always 0.

UNLock (No Query Form)

Unlocks the front panel. This command is equivalent to LOCK NONE.

NOTE. If the digitizing oscilloscope is in the Remote With Lockout State (RWLS), the UNLOCK command has no effect. For more information see the ANSI-IEEE Std. 488.1-1987 Standard Digital Interface for Programmable Instrumentation, section 2.8.3 on RL State Descriptions.

Group Miscellaneous

Related Commands LOCK

Syntax UNLock ALL

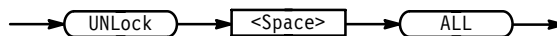

Arguments ALL specifies all front-panel buttons and knobs.

VERBose

Sets and queries the Verbose State that controls the length of keywords on query responses. Keywords can be both headers and arguments. This command does not affect IEEE Std 488.2-1987 Common Commands (those starting with an asterisk).

Group Miscellaneous

Related Commands HEADer, *LRN?, SET?

Syntax VERBose { OFF | ON | <NR1> }
VERBose?

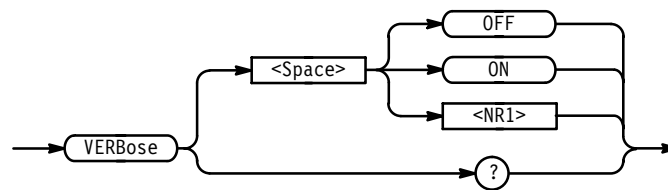

Arguments ON or <NR1> $\neq 0$ sets the Verbose State true, which returns full-length keywords for applicable setting queries.

OFF or <NR1> = 0 sets the Verbose State false, which returns minimum-length keywords for applicable setting queries.

Examples VERBOSE ON
sets the Verbose State true.

VERBOSE?
might return the value 1, showing that the Verbose State is true.

*WAI (No Query Form)

(Wait) Prevents the digitizing oscilloscope from executing further commands or queries until all pending operations finish. This command allows you to synchronize the operation of the digitizing oscilloscope with your application program. Synchronization methods are described on page 3–7.

Group Status and Error

Related Commands BUSY?, *OPC

Syntax *WAI



WAVFrm? (Query Only)

Returns WFMPre? and CURVe? data for the waveform or waveforms as specified by the DATA:SOURce command. This command is equivalent to sending WFMPre?; CURVe?

TDS 4XXA: when the TDS 4XXA is in external clock mode, the time-per-div field will contain 50 c1ks/div.

Group Waveform

Related Commands CURVe?, DATA:SOURce, WFMPre?

Syntax WAVFrm?

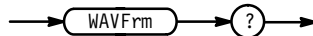

WFMPre? (Query Only)

Returns the waveform formatting data for the first ordered waveform as specified by the DATA:SOURce command. The channel and math waveforms selected by the data:source command must be displayed.

TDS 4XXA: when the TDS 4XXA is in external clock mode, the time-per-div field will contain 50 c1ks/div.

Group Waveform

Related Commands WAVFrm?

Syntax WFMPre?

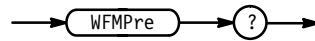

Returns The format of the response is:

```

BYT_Nr <NR1>;BIT_Nr <NR1>;ENCdg { ASC | BIN };
BN_Fmt { RI | RP };BYT_Or { LSB | MSB };
<wfm>:WFID <Qstring>;NR_PT <NR1>;PT_FMT { ENV | Y };
XUNit <QString>;XINcr <NR3>;PT_Off <NR1>;YUNit <QString>;YMUlt
<NR3>; YOff <NR3>;YZEro<NR3>[;<wfm>:
WFID <Qstring>;NR_PT <NR1>;PT_FMT{ ENV | Y };
XUNit<QString>;XINcr <NR3>;PT_Off <NR1>;YUNit <QString>;
YMUlt <NR3>; YOff <NR3>;YZEro <NR3>...]
```

WFMPre:BIT_Nr

Returns the number of bits per binary waveform point for the first ordered waveform as specified by the DATA:SOURce command. The WFMPre:BIT_Nr command is ignored on input.

Group Waveform

Related Commands DATA:WIDth, WFMPre:BYT_Nr

Syntax WFMPre:BIT_Nr <NR1>

WFMPre:BIT_Nr?

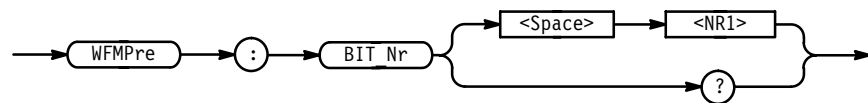

Arguments <NR1> is either 8 or 16, and is equivalent to WFMPre:BYT_Nr * 8.

Examples WFMPRE:BIT_NR?
might return 8, indicating that there are 8 bits per waveform point.

WFMPre:BN_Fmt

Sets or queries the format of binary data for the first ordered waveform as specified by the DATA:SOURce command.

Group Waveform

Related Commands DATA:ENCdg, WFMPre:BYT_Or, WFMPre:ENCdg

Syntax WFMPre:BN_Fmt { RI | RP }
 WFMPre:BN_Fmt?

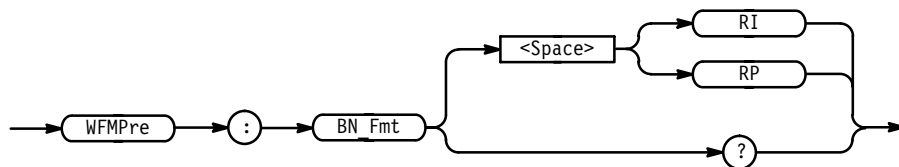

Arguments RI specifies signed integer data-point representation.
 RP specifies positive integer data-point representation.

Examples WFMPRE:BN_FMT RP
 specifies that the binary waveform data are positive integer data-points.
 WFMPRE:BN_FMT?
 returns either RI or RP as the current waveform data format.

WFMPre:BYT_Nr

Sets or queries the binary field data width for the first ordered waveform as specified by the DATA:SOURce command. This command is equivalent to the DATA:WIDth command.

Group Waveform

Related Commands DATA:WIDth, WFMPre:BIT_Nr

Syntax WFMPre:BYT_Nr <NR1>
 WFMPre:BYT_Nr?

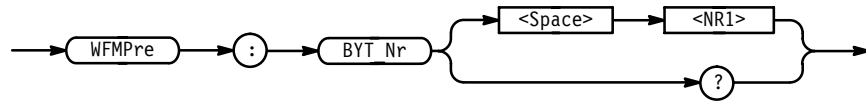

Arguments <NR1> is the number of bytes per point and can be 1 or 2.

Examples WFMPre:BYT_Nr 2
specifies that there are 2 bytes per waveform data point.

WFMPre:BYT_Or

Selects which byte of binary waveform data is transmitted first during a waveform data transfer when DATA:WIDTH (or WFMPre:BYT_Nr) is set to 2.

Group Waveform

Related Commands DATA:ENCdg, WFMPre:BN_Fmt, WFMPre:ENCdg

Syntax WFMPre:BYT_Or { LSB | MSB }
WFMPre:BYT_Or?

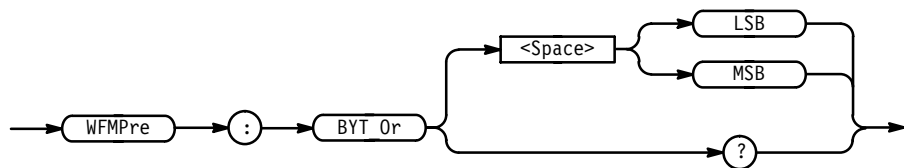

Arguments LSB selects the least significant byte to be transmitted first.
MSB selects the most significant byte to be transmitted first.

Examples WFMPre:BYT_OR MSB
specifies that the most significant byte in the waveform data will be transferred first.
WFMPre:BYT_OR?
returns either MSB or LSB depending on which data byte is transferred first.

WFMPre:ENCdg

Sets or queries the type of encoding for waveform data transferred with the CURVe command.

Group Waveform

Related Commands DATA:ENCdg, WFMPre:BYT_Or, WFMPre:BN_Fmt

Syntax WFMPre:ENCdg { ASC | BIN }
WFMPre:ENCdg?

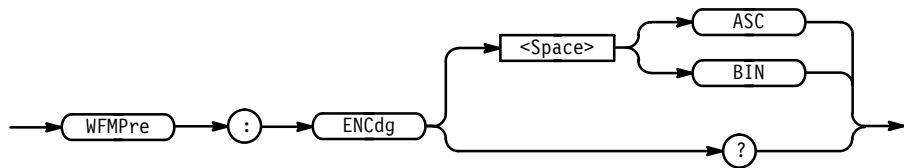

Arguments ASC specifies ASCII curve data.
BIN specifies binary curve data.

Examples WFMPRE:ENCDG ASC
specifies that the waveform data is in ASCII format.

WFMPRE:ENCDG?
might return BIN, indicating that the waveform data is in binary format.

WFMPre:PT_Fmt (No Query Form)

Selects the point format of the waveform data for the first ordered waveform as specified by the DATA:SOURce command.

Group Waveform

Syntax WFMPre:PT_Fmt { ENV | Y }

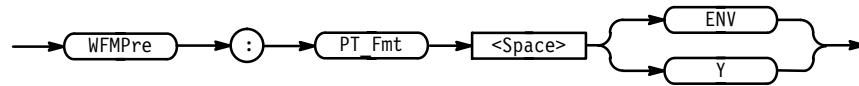

Arguments ENV specifies that the waveform is transmitted as maximum and minimum point pairs. Only y values are explicitly transmitted. Absolute coordinates are given by:

$$X_n = 0 + XINcr (n - PT_Off)$$

$$Y_{n_{max}} = YZEro + YMUlt (y_{n_{max}} - YOOf)$$

$$Y_{n_{min}} = YZEro + YMUlt (y_{n_{min}} - YOOf)$$

Y specifies a normal waveform where one ASCII or binary data point is transmitted for each point in the waveform record. Only y values are explicitly transmitted. Absolute coordinates are given by:

$$X_n = 0 + XINcr (n - PT_Off)$$

$$Y_n = YZEro + YMUlt (y_n - YOOf)$$

Examples WFMPre:PT_Fmt ENV
sets the waveform data point format to enveloped.

WFMPre:PT_Off (No Query Form)

Specifies the trigger point within the waveform record for the reference waveform specified by the DATA:DESTINATION command.

Group Waveform

Related Commands HORizontal:TRIGger:POsition

Syntax WFMPre:PT_Off <NR1>

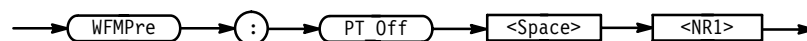

Arguments <NR1> = 0 to the recordlength, and is the position of the trigger point relative to DATA:STARt.

Examples WFMPre:PT_Off 1
specifies that the trigger point is the first point in the waveform record.

WFMPre:XINcr (No Query Form)

Specifies the horizontal sampling interval for the reference waveform specified by the DATA:DESTINATION command.

Group Waveform

Syntax WFMPre:XINcr <NR3>

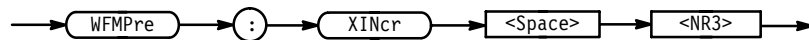

Arguments <NR3> is the sampling interval in seconds per point.

WFMPre:YMUIt (No Query Form)

Specifies the vertical scale factor for the reference waveform specified by the DATA:DESTINATION command.

Group Waveform

Syntax WFMPre:YMUIt <NR3>

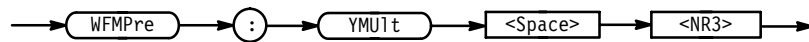

Arguments <NR3> is the vertical scale factor in YUNits (usually volts) per division.

WFMPre:YOff (No Query Form)

Specifies the offset of the vertical component for the reference waveform specified by the DATA:DESTINATION command.

Group Waveform

Syntax WFMPre:YOff <NR3>

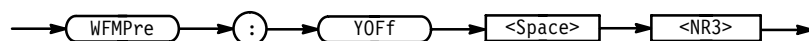

Arguments <NR3> is the vertical offset in digitizing levels.

WFMPre:YZero (No Query Form)

Specifies the offset voltage for the reference waveform specified by the DATA:DESTINATION command.

Group Waveform

Syntax WFMPre:YZero <NR3>

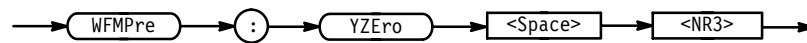

Arguments <NR3> is of the offset in YUNits (usually volts).

Table 2–32 lists additional WFMPre commands that are included for compatibility purposes.

NOTE. These commands do not support a query form and all information is ignored.

Table 2–32: Additional WFMPre Commands

Command	Argument	Description
WFMPre:CRVchk	{CHKsmo NONE}	Binary curve error check
WFMPre:NR_PT	<NR1>	Number of waveform points
WFMPre:WFId	<QString>	Waveform identifier
WFMPre:XUNit	<QString>	Horizontal units
WFMPre:XMUlt	<NR3>	Horizontal (X-axis) scale factor
WFMPre:XOff	<NR3>	Horizontal (X-axis) offset
WFMPre:XZEro	<NR3>	Horizontal (X-axis) origin offset
WFMPre:YUNit	<QString>	Vertical units
WFMPre:ZMUlt	<NR3>	Z-axis scale factor
WFMPre:ZOff	<NR3>	Z-axis offset
WFMPre:ZUNit	<QString>	Z-axis units
WFMPre:ZZEro	<NR3>	Z-axis origin offset

NOTE. When returning `WFMPRE:<wfm>` information from the oscilloscope, `<wfm>` specifies the waveform source (`CH<x>`, `MATH<x>`, or `REF<x>`). The source must also be set using the `DATA:SOURce` command. When sending `WFMPRE:<wfm>` information to the scope, the `<wfm>` specification is ignored and the reference location specified by `DATA:DESTination` is used instead.

WFMPre:<wfm>? (Query Only)

Returns the waveform formatting data for first ordered waveform as specified by the `DATA:SOURce` command. Channel and math waveforms must be displayed before they can be queried. Querying an invalid reference waveform generates an execution error.

Group Waveform

Syntax `WFMPre:<wfm>?`

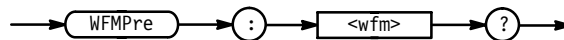

Returns The format of the response is:

```

<wfm>:WFID <Qstring>;NR_PT <NR1>;PT_FMT { ENV | Y };
XUNit <QString>;XINcr <NR3>;PT_Off <NR1>;YUNit <QString>;YMUlt
<NR3>;YOff <NR3>;YZero <NR3>
[;<wfm>:WFID <Qstring>;NR_PT <NR1>;
PT_FMT { ENV | Y };XUNit <QString>;XINcr <NR3>;
PT_Off <NR1>;YUNit <QString>;YMUlt <NR3>;YOff <NR3>;
YZero <NR3>...]
  
```

WFMPre:<wfm>:NR_Pt

Sets or queries the number of points that are in the transmitted waveform record. This value is ignored on input.

Related Commands `DATA:DESTination`

Group Waveform

Syntax `WFMPre:<wfm>:NR_Pt <NR1>`

WFMPre:<wfm>:NR_Pt?

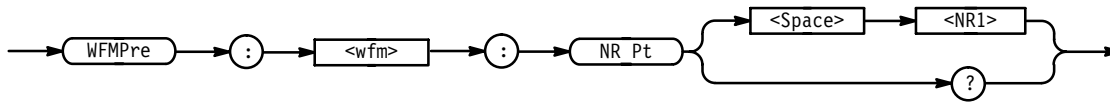

Arguments <NR1> is the number of data points. If DATA:WIDTH is 2 then there are twice as many bytes.

<NR1> = 0 means that the waveform record is of an unspecified length.

Examples WFMPRE:CH1:NR_Pt?
might return 5000 as the number of data points in the waveform record transferred from channel 1.

WFMPre:<wfm>:PT_Fmt

Selects the data point format for the first ordered waveform as selected by the DATA:SOURce command. On input <wfm> always defaults to the reference location specified by DATA:DESTination regardless of what is sent.

Group Waveform

Related Commands DATA:DESTination

Syntax WFMPre:<wfm>:PT_Fmt { ENV | Y }

WFMPre:<wfm>:PT_Fmt?

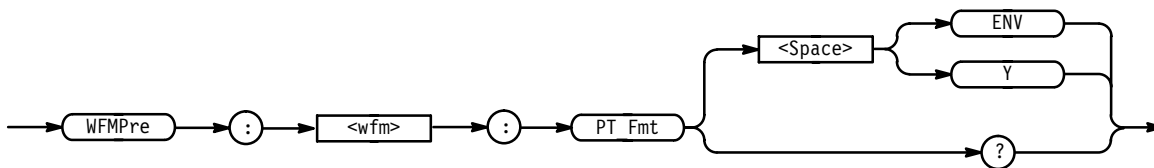

Arguments ENV specifies that the waveform is transmitted as minimum and maximum point pairs. Only y values are explicitly transmitted. Absolute coordinates are given by:

$$X_n = 0 + XINcr (n - PT_Off)$$

$$Y_{n_{min}} = YZero + YMult (y_{n_{min}} - YOYf)$$

$$Y_{n_{max}} = YZEro + YMult (y_{n_{max}} - YOFf)$$

Y specifies a normal waveform where one ASCII or binary data point is transmitted for each point in the waveform record. Only y values are explicitly transmitted. Absolute coordinates are given by:

$$X_n = 0 + XINcr (n - PT_Off)$$

$$Y_n = YZEro + YMult (y_n - YOFf)$$

Examples WFMPre:MATH1:PT_FMT?
 might return ENV, indicating that the MATH1 waveform data format is enveloped.

WFMPre:<wfm>:PT_Off

Returns the trigger point within the waveform record. On input <wfm> always defaults to the reference location specified by DATA:DESTINATION regardless of what is sent.

Group Waveform

Syntax WFMPre:<wfm>:PT_Off <NR1>
 WFMPre:<wfm>:PT_Off?

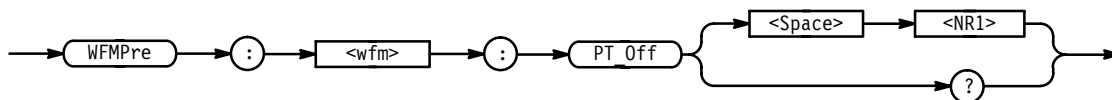

Arguments <NR1> = 0 to the recordlength, and is the position of the trigger point relative to DATA:START when queried.

Examples WFMPre:CH1:PT_OFF?
 returns 0 indicating the trigger position within the waveform record.

WFMPre:<wfm>:WFId

Returns information about the waveform such as input coupling, volts per division, time per division, acquisition mode, and record length.

The WFMPre:<wfm>:WFId command is ignored on input.

TDS 4XXA: when the TDS 4XXA is in external clock mode, the time-per-div field will contain “50 clks/div”.

Group Waveform

Syntax WFMPre:<wfm>:WFId <QString>

WFMPre:<wfm>:WFId?

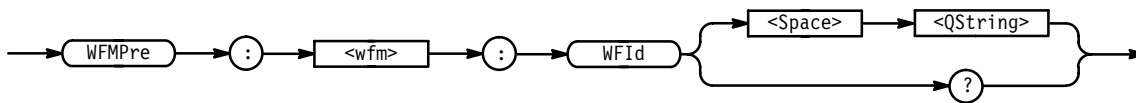

Arguments <QString> is the waveform identifier string.

WFMPre:<wfm>:XINcr

Sets or queries the horizontal sampling interval. On input <wfm> always defaults to the reference location specified by DATA:DESTINATION regardless of what is sent.

TDS 4XXA: when the TDS 4XXA is in external clock mode, the time-per-div field will contain “50 clks/div”.

Group Waveform

Syntax WFMPre:<wfm>:XINcr <NR3>

WFMPre:<wfm>:XINcr?

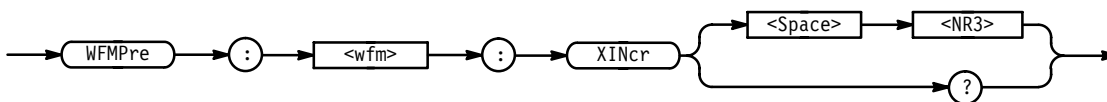

Arguments <NR3> is the sampling interval.

WFMPre:<wfm>:XUNit

Returns the horizontal (X-axis) units of the waveform data at the time of creation.

The WFMPre:<wfm>:XUNit command is ignored on input.

TDS 4XXA: when the TDS 4XXA is in external clock mode, the time-per-div field will contain "50 clks/div".

Group Waveform

Syntax WFMPre:<wfm>:XUNit <QString>

WFMPre:<wfm>:XUNit?

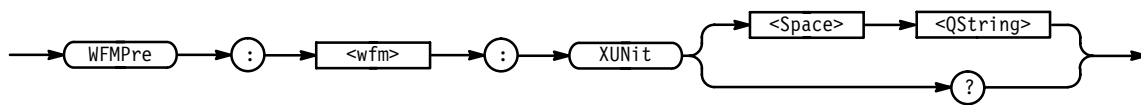

Arguments <QString> is "s" for seconds and specifies the units.

Examples WFMPRE:CH1:XUNIT?
 might return "s", indicating that the horizontal units for channel 1 are seconds.

WFMPre:<wfm>:YMUIt

Sets or queries the vertical scale factor, in YUNit per unscaled data point value. On input <wfm> always defaults to the reference location specified by DATA:DESTination regardless of what is sent.

Group Waveform

Syntax WFMPre:<wfm>:YMUIt <NR3>

WFMPre:<wfm>:YMUIt?

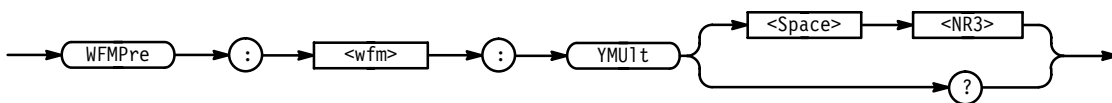

Arguments <NR3> is the scale factor, in YUNits (usually volts), per digitizing level.

WFMPre:<wfm>:YOff

Sets or queries the vertical position of the waveform. On input <wfm> always defaults to the reference location specified by DATA:DESTINATION regardless of what is sent.

Group Waveform

Syntax WFMPre:<wfm>:YOff <NR3>

WFMPre:<wfm>:YOff?

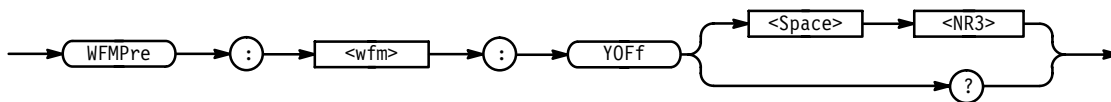

Arguments <NR3> is the position in digitizing levels.

WFMPre:<wfm>:YUnit

Returns the vertical (Y-axis) units of the waveform data at the time of creation. The WFMPre:<wfm>:YUnit command is ignored on input.

Group Waveform

Syntax WFMPre:<wfm>:YUnit <QString>

WFMPre:<wfm>:YUnit?

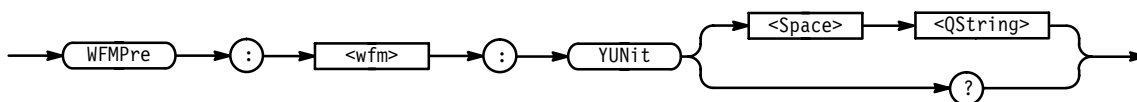

Arguments <QString> is "V" for volts or "VV" for volts², and specifies the units.

Examples WFMPRE:CH2:YUNIT?
might return "V", meaning that the units for the vertical component of the channel 2 waveform data are volts.

WFMPre:<wfm>:YZero

Sets or queries the vertical (Y-axis) offset voltage. On input <wfm> always defaults to the reference location specified by DATA:DESTINATION regardless of what is sent.

Group Waveform

Syntax WFMPre:<wfm>:YZero <NR3>

WFMPre:<wfm>:YZero?

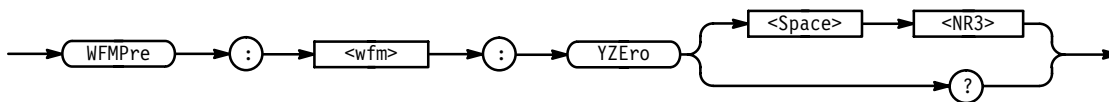

Arguments <NR3> is the offset in YUNits (usually volts).

ZOOM

Resets the zoom transforms to default values for all traces or live traces. The ZOOM query returns the current vertical and horizontal positioning and scaling of the display. This command is equivalent to selecting **Reset All Factors** or **Reset Live Factors** in the TDS 7XXA Zoom Reset menu or selecting **Reset Zoom Factors** in the Zoom menu of other TDS oscilloscopes.

Group Zoom

Syntax ZOOM { RESET | RESETLive (TDS 4XXA and 7XXA only) }

ZOOM?

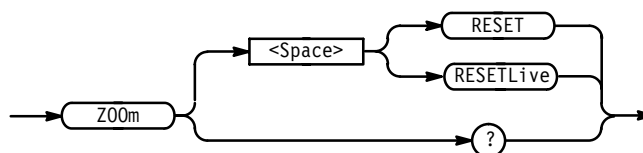

Arguments RESET resets the zoom transforms to default values for all traces.

RESETLive (TDS 4XXA and 7XXA only) resets the zoom transforms to default values for live traces.

Examples ZOOM?
 might return :ZOOM:STATE OFF;HORIZONTAL:SCALE 2.00E+0;POSITION 500.0E-3;LOCK LIVE;;ZOOM:VERTICAL:SCALE 2.0E+0;POSITION 0.0E+0.

ZOOM:DUAL

TDS 4XXA & 7XXA Only

Turns Dual Zoom mode on and off.

Group Zoom

Syntax ZOOM:DUAL { OFF | ON | <NR1> }
 ZOOM:DUAL?

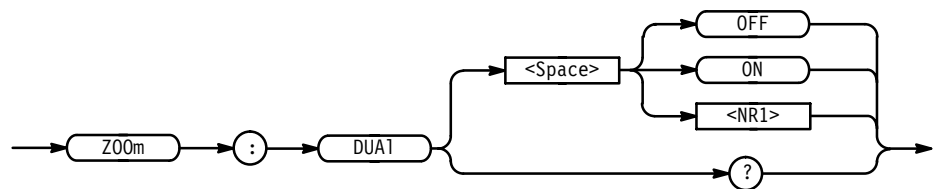

Arguments OFF or <NR1> = 0 turns Dual Zoom mode off.
 ON or <NR1> \neq 0 turns Dual Zoom mode on.

Examples ZOOM:DUAL ON
 enables the Dual Zoom feature.
 ZOOM:DUAL?
 returns either 0 or 1 depending on the state of Dual Zoom mode.

ZOOM:DUAL:OFFSet

TDS 4XXA & 7XXA Only

Adjusts the requested horizontal offset between the centers of the main and second zoom boxes.

Group Zoom

Syntax ZOOM:DUAL:OFFSet <NR3>

ZOOM:DUAL:OFFSet?

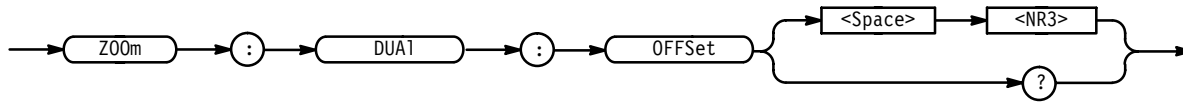

Arguments <NR3> is the offset time in seconds.

Examples ZOOM:DUAL:OFFSET 100.0E-6
adjusts the offset time in seconds between the centers of the main and second zoom boxes.

ZOOM:GRAticule

TDS 4XXA & 7XXA Only

Selects between the upper and lower graticule for use by the zoom preview state. If you select the lower graticule, horizontal and vertical knob changes will affect the underlying acquisition system. If you select the upper graticule, horizontal and vertical knob changes will affect the zoom factors.

Group Zoom

Syntax ZOOM:GRAticule { LOWEr | UPPer }

ZOOM:GRAticule?

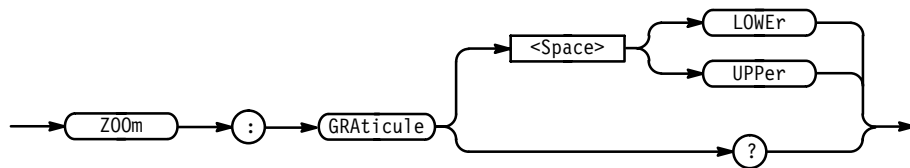

Arguments LOWEr selects the lower graticule.

UPPer selects the upper graticule.

Examples ZOOM:GRATICULE?
might return UPPER, indicating that the upper graticule is selected.

ZOOM:HORIZONTAL:LOCK

Specifies the waveforms that the horizontal zoom parameters affect. This is equivalent to setting **Horizontal Lock** in the Zoom side menu.

Group Zoom

Syntax ZOOM:HORIZONTAL:LOCK { ALL | LIVE | NONE }
ZOOM:HORIZONTAL:LOCK?

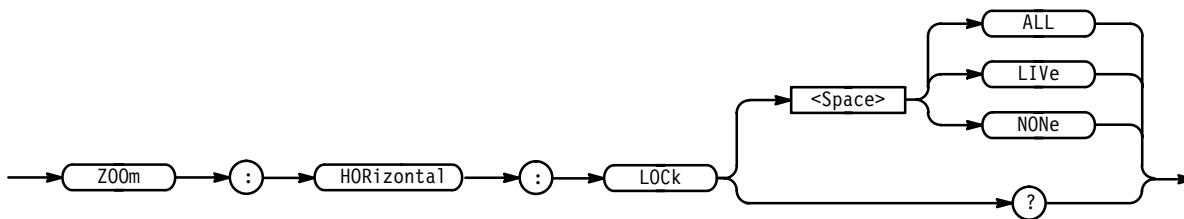

Arguments LIVE specifies that all live (CH<x>) waveforms will be horizontally positioned and scaled together.

NONE specifies that only the selected waveform is positioned and scaled using the horizontal zoom parameters.

ALL specifies that all (CH<x>, Ref<x>, Math<x>) waveforms will be horizontally positioned and scaled together.

Examples ZOOM:HORIZONTAL:LOCK LIVE
specifies that all live waveforms are positioned and scaled together.

ZOOM:HORIZONTAL:LOCK?
returns either ALL, LIVE, or NONE.

ZOOM:HORIZONTAL:POSITION

Sets or queries the horizontal position of zoomed waveforms. The setting of the ZOOM:HORIZONTAL:LOCK command determine the waveforms affected. For example, if ZOOM:HORIZONTAL:LOCK is set to LIVE then only live (as opposed to reference and math) waveforms are affected.

Group Zoom

Syntax ZOOM:HORizontal:POSition <NR3>
 ZOOM:HORizontal:POSition?

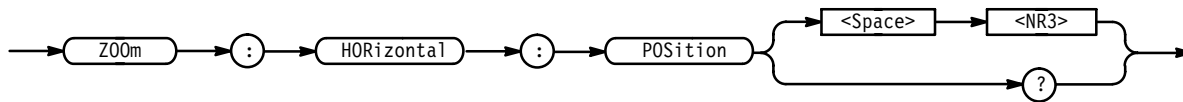

Arguments <NR3> is from 0 to 100, and is the percent of the waveform that is to the left of screen center when the zoom factor is 1x or greater.

It is the percent of the graticule to the right of the waveform center when the zoom factor is less than 1. It can be less than 1 when using Fit to Screen.

Examples ZOOM:HORIZONTAL:POSITION 50
 centers the waveform on the display.

ZOOM:HORizontal:SCALE

Sets or queries the horizontal expansion factor. This command is equivalent to using the front-panel **Horizontal Scale** knob when Zoom is on. It is also equivalent to using **Zoom Preview** with the upper graticule selected in the TDS 7XXA.

Group Zoom

Syntax ZOOM:HORizontal:SCALE <NR3>
 ZOOM:HORizontal:SCALE?

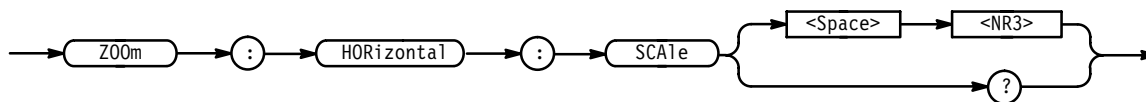

Arguments <NR3> is the amount of expansion in the horizontal direction.

It is less than 1 if there is horizontal compression.

It is more than 1 if there is horizontal expansion.

Examples ZOOM:HORIZONTAL:SCALE?
might return 1.00E+0 as the horizontal scale factor.

ZOOM:STATE

Turns Zoom mode on and off. When Zoom mode is on, the horizontal and vertical position and scale commands affect the waveform display, not the acquisition. This is the only way to position and scale math and reference waveforms. This command is equivalent to turning **Zoom** on and off in the Zoom side menu.

Group Zoom

Syntax ZOOM:STATE { <NR1> | OFF | ON | PREView (TDS 4XXA and 7XXA) }
ZOOM:STATE?

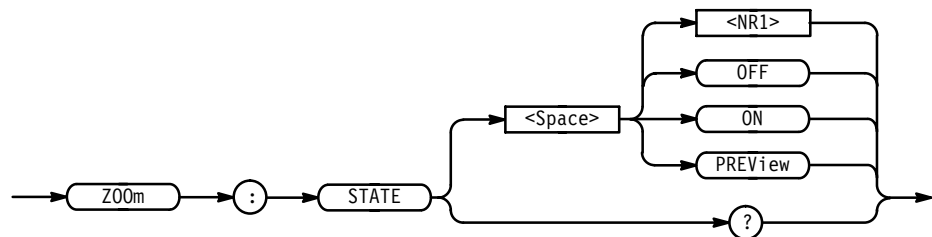

Arguments OFF or <NR1> = 0 turns Zoom mode off.

ON or <NR1> \neq 0 turns Zoom mode on. When InstaVu is in use, the state value becomes a requested value, to be restored when InstaVu is switched off. Do not use this condition if InstaVu is on. InstaVu overrides the zoom on state.

PREView (TDS 4XXA and 7XXA) sets ZOOM:STATE to preview. Also, it causes the oscilloscope to display both the ZOOM:STATE OFF and ZOOM:STATE ON traces simultaneously in dual, half-height graticules. Do not use this condition if InstaVu is on. InstaVu overrides the zoom preview state.

Examples ZOOM:STATE ON
enables the Zoom feature.

ZOOM:STATE?
returns either 0 or 1 (OFF, PREVIEW, or ON for the TDS 4XXA and 7XXA) depending on the state of Zoom mode.

ZOOM:VERTICAL:POSITION

Sets or queries the vertical position of waveforms.

Group Zoom

Syntax ZOOM:VERTICAL:POSITION <NR3>
ZOOM:VERTICAL:POSITION?

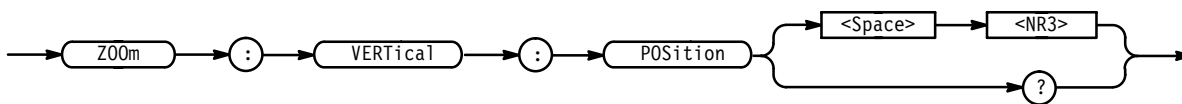

Arguments <NR3> is the vertical position in divisions.

Examples ZOOM:VERTICAL:POSITION?
might return :ZOOM:VERTICAL:POSITION 0.0E+0

ZOOM:VERTICAL:SCALE

Sets or queries the vertical expansion and compression factor.

Group Zoom

Related Commands ACQUIRE:MODE

Syntax ZOOM:VERTICAL:SCALE <NR3>
ZOOM:VERTICAL:SCALE?

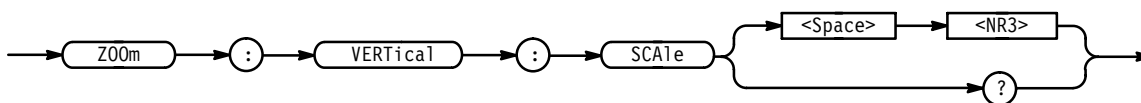

Arguments <NR3> is the amount of vertical expansion or compression.

Examples ZOOM:VERTICAL:SCALE?
might return :ZOOM:VERTICAL:SCALE 2.0E+0

Status and Events

The digitizing oscilloscope provides a status and event reporting system for the GPIB interface. This system informs you of certain significant events that occur within the digitizing oscilloscope.

The digitizing oscilloscope status handling system consists of five 8-bit registers and two queues. This section describes these registers and components. It also explains how the event handling system operates.

Registers

The registers in the event handling system fall into two functional groups:

- Status Registers contain information about the status of the digitizing oscilloscope. They include the Standard Event Status Register (SESR) and the Status Byte Register (SBR).
- Enable Registers determine whether selected types of events are reported to the Status Registers and the Event Queue. They include the Device Event Status Enable Register (DESER), the Event Status Enable Register (ESER), and the Service Request Enable Register (SRER).

Status Registers

The Standard Event Status Register (SESR) and the Status Byte Register (SBR) record certain types of events that may occur while the digitizing oscilloscope is in use. IEEE Std 488.2–1987 defines these registers.

Each bit in a Status Register records a particular type of event, such as an execution error or service request. When an event of a given type occurs, the digitizing oscilloscope sets the bit that represents that type of event to a value of one. (You can disable bits so that they ignore events and remain at zero. See the Enable Registers section on page 3–3.) Reading the status registers tells you what types of events have occurred.

The Standard Event Status Register (SESR). The SESR, shown in Figure 3–1, records eight types of events that can occur within the digitizing oscilloscope. Use the *ESR? query to read the SESR register. Reading the register clears the bits of the register so that the register can accumulate information about new events.

7	6	5	4	3	2	1	0
PON	URQ	CME	EXE	DDE	QYE	RQC	OPC

Figure 3–1: The Standard Event Status Register (SESR)

Table 3–1: SESR Bit Functions

Bit	Function
7 (MSB)	PON (Power On). Shows that the digitizing oscilloscope was powered on. The completion of the diagnostic tests also sets this bit.
6	URQ (User Request). Shows that an Application menu button was pressed.
5	CME (Command Error). Shows that an error occurred while the digitizing oscilloscope was parsing a command or query. Command error messages are listed in Table 3–4 on page 3–12.
4	EXE (Execution Error). Shows that an error occurred while the digitizing oscilloscope was executing a command or query. Execution error messages are listed in Table 3–5 on page 3–14.
3	DDE (Device Error). Shows that a device error occurred. Device error messages are listed in Table 3–6 on page 3–17.
2	QYE (Query Error). Shows that either an attempt was made to read the Output Queue when no data was present or pending, or that data in the Output Queue was lost.
1	RQC (Request Control). Not used.
0 (LSB)	OPC (Operation Complete). Shows that the operation is complete. This bit is set when all pending operations complete following an *OPC command.

The Status Byte Register (SBR) — shown in Figure 3–2, records whether output is available in the Output Queue, whether the digitizing oscilloscope requests service, and whether the SESR has recorded any events.

Use a Serial Poll or the *STB? query to read the contents of the SBR. The bits in the SBR are set and cleared depending on the contents of the SESR, the Event Status Enable Register (ESER), and the Output Queue. When you use a Serial Poll to obtain the SBR, bit 6 is the RQS bit. When you use the *STB? query to obtain the SBR, bit 6 is the MSS bit. Reading the SBR does not clear the bits.

7	6	5	4	3	2	1	0
—	RQS	ESB	MAV	—	—	—	—
	MSS						

Figure 3–2: The Status Byte Register (SBR)

Table 3–2: SBR Bit Functions

Bit	Function
7 (MSB)	Not used.
6	RQS (Request Service), obtained from a serial poll. Shows that the digitizing oscilloscope requests service from the GPIB controller.
6	MSS (Master Status Summary), obtained from *STB? query. Summarizes the ESB and MAV bits in the SBR.
5	ESB (Event Status Bit). Shows that status is enabled and present in the SESR.
4	MAV (Message Available). Shows that output is available in the Output Queue.
3 – 0	Not used.

Enable Registers

DESER, ESER, and SRER allow you to select which events are reported to the Status Registers and the Event Queue. Each Enable Register acts as a filter to a Status Register (the DESER also acts as a filter to the Event Queue) and can prevent information from being recorded in the register or queue.

Each bit in an Enable Register corresponds to a bit in the Status Register it controls. In order for an event to be reported to its bit in the Status Register, the corresponding bit in the Enable Register must be set to one. If the bit in the Enable Register is set to zero, the event is not recorded.

Various commands set the bits in the Enable Registers. The Enable Registers and the commands used to set them are described below.

The Device Event Status Enable Register (DESER) — is shown in Figure 3–3. This register controls which types of events are reported to the SESR and the Event Queue. The bits in the DESER correspond to those in the SESR, as described earlier.

Use the DESE command to enable and disable the bits in the DESER. Use the DESE? query to read the DESER.

7	6	5	4	3	2	1	0
PON	URQ	CME	EXE	DDE	OYE	RQC	OPC

Figure 3–3: The Device Event Status Enable Register (DESER)

The Event Status Enable Register (ESER) — is shown in Figure 3–4. It controls which types of events are summarized by the Event Status Bit (ESB) in the SBR.

Use the *ESE command to set the bits in the ESER. Use the *ESE? query to read it.

7	6	5	4	3	2	1	0
PON	URQ	CME	EXE	DDE	QYE	RQC	OPC

Figure 3-4: The Event Status Enable Register (ESER)

The Service Request Enable Register (SRER) — is shown in Figure 3-5. It controls which bits in the SBR generate a Service Request and are summarized by the Master Status Summary (MSS) bit.

Use the *SRE command to set the SRER. Use the *SRE? query to read it. The RQS bit remains set to one until either the Status Byte Register is read with a Serial Poll or the MSS bit changes back to a zero.

7	6	5	4	3	2	1	0
—	—	ESB	MAV	—	—	—	—

Figure 3-5: The Service Request Enable Register (SRER)

The Enable Registers and the *PSC Command

The *PSC command controls the Enable Registers contents at power-on. Sending *PSC 1 sets the Enable Registers at power on as follows:

- DESER 255 (equivalent to a DESe 255 command)
- ESER 0 (equivalent to an *ESE 0 command)
- SRER 0 (equivalent to an *SRE 0 command)

Sending *PSC 0 lets the Enable Registers maintain their values in non-volatile memory through a power cycle.

NOTE. To enable the PON (Power On) event to generate a Service Request, send *PSC 0, use the DESe and *ESE commands to enable PON in the DESER and ESER, and use the *SRE command to enable bit 5 in the SRER. Subsequent power-on cycles will generate a Service Request.

Queues

The digitizing oscilloscope status and event reporting system contains two queues: the Output Queue and the Event Queue.

The Output Queue

The digitizing oscilloscope stores query responses in the Output Queue. It empties this queue each time it receives a new command or query message after an <EOM>. The controller must read a query response before it sends the next command (or query) or it will lose responses to earlier queries.



WARNING. When a controller sends a query, an <EOM>, and a second query, the digitizing scope normally clears the first response and outputs the second while reporting a Query Error (QYE bit in the ESR) to indicate the lost response. A fast controller, however, may receive a part or all of the first response as well. To avoid this situation, the controller should always read the response immediately after sending any terminated query message or send a DCL (Device Clear) before sending the second query.

The Event Queue

The Event Queue stores detailed information on up to 20 events. If more than 20 events stack up in the Event Queue, the 20th event is replaced by event code 350, “Too many events.”

Read the Event Queue with the EVENT? query (which returns only the event number), with the EVMSG? query (which returns the event number and a text description of the event), or with the ALLEV? query (which returns all the event numbers along with a description of the event). Reading an event removes it from the queue.

Before reading an event from the Event Queue, you must use the *ESR? query to read the summary of the event from the SESR. This makes the events summarized by the *ESR? read available to the EVENT? and EVMSG? queries, and empties the SESR.

Reading the SESR erases any events that were summarized by previous *ESR? reads but not read from the Event Queue. Events that follow an *ESR? read are put in the Event Queue but are not available until *ESR? is used again.

Event Handling Sequence

Figure 3–6, on page 3–6, shows how to use the status and event handling system. In the explanation that follows, numbers in parentheses refer to numbers in Figure 3–6.

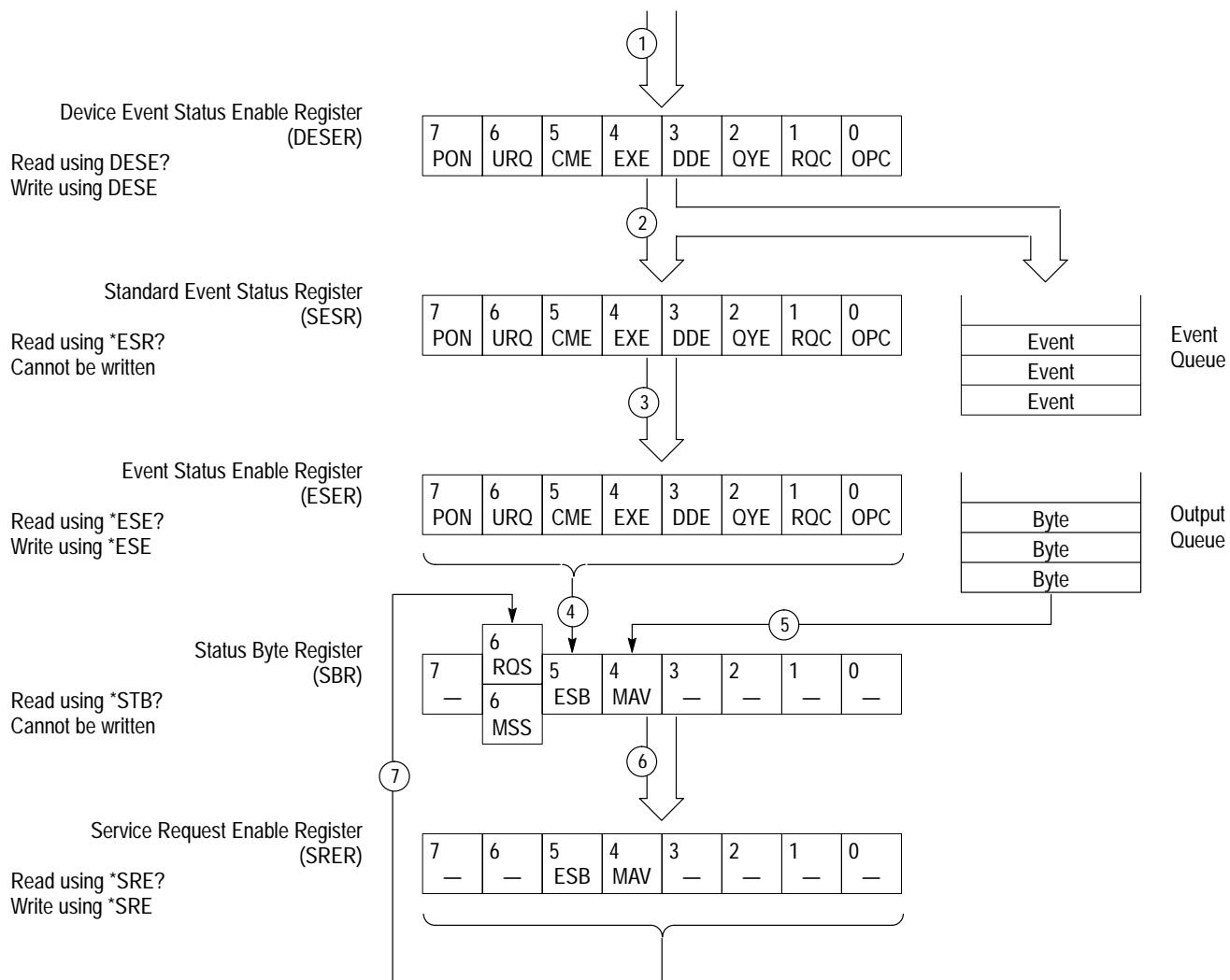

Figure 3–6: Status and Event Handling Process

When an event occurs, a signal is sent to the DESER (1). If that type of event is enabled in the DESER (that is, if the bit for that event type is set to 1), the appropriate bit in the SESR is set to one, and the event is recorded in the Event Queue (2). If the corresponding bit in the ESER is also enabled (3), then the ESB bit in the SBR is set to one (4).

When output is sent to the Output Queue, the MAV bit in the SBR is set to one (5).

When a bit in the SBR is set to one and the corresponding bit in the SRER is enabled (6), the MSS bit in the SBR is set to one and a service request is generated (7).

Synchronization Methods

Although most GPIB commands are completed almost immediately after being received by the digitizing oscilloscope, some commands start a process that requires more time. For example, once a **HARDCOPY START** command is executed it may be a few seconds before the hardcopy operation is complete. Rather than remain idle while the operation is in process, the digitizing oscilloscope will continue processing other commands. This means that some operations will not be completed in the order that they were sent.

Sometimes the result of an operation depends on the result of an earlier operation. A first operation must complete before the next one gets processed. The digitizing oscilloscope status and event reporting system provide ways to do this.

For example, a typical application might involve acquiring a single-sequence waveform and then taking a measurement on the acquired waveform. You could use the following command sequence to do this:

```
/** Set up single-sequence acquisition **/  
SELECT:CH1 ON  
HORIZONTAL:RECORDLENGTH 500  
ACQUIRE:MODE NORMALSAMPLE  
ACQUIRE:STOPAFTER SEQUENCE  
/** Acquire waveform data **/  
ACQUIRE:STATE ON  
/** Set up the measurement parameters **/  
MEASUREMENT:IMMED:TYPE AMPLITUDE  
MEASUREMENT:IMMED:SOURCE CH1  
/** Take amplitude measurement on acquired data **/  
MEASUREMENT:IMMED:VALUE?
```

The acquisition of the waveform requires extended processing time. It may not finish before the digitizing oscilloscope takes an amplitude measurement (See Figure 3-7). This can result in an incorrect amplitude value.

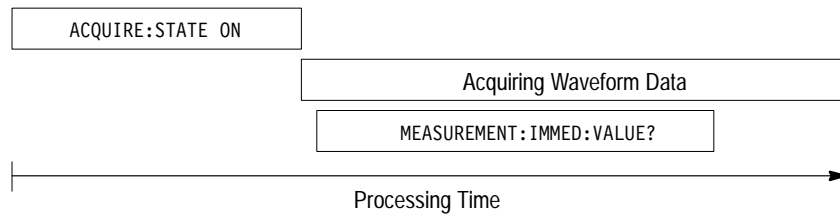

Figure 3-7: Command Processing Without Using Synchronization

To ensure the digitizing oscilloscope completes waveform acquisition before taking the measurement on the acquired data, you can synchronize the program. Figure 3-8 shows the desired processing sequence.

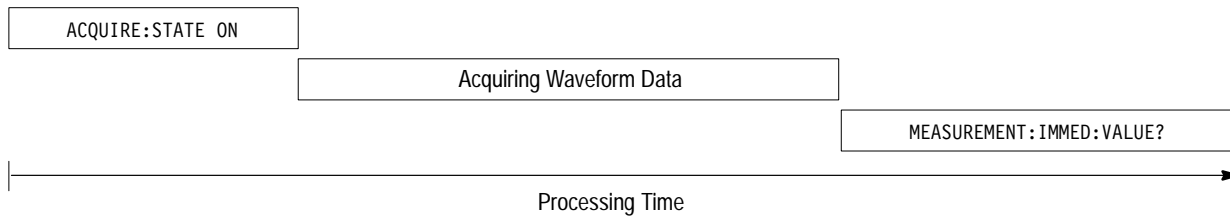

Figure 3-8: Processing Sequence With Synchronization

You can use four commands to synchronize the operation of the digitizing oscilloscope with your application program: `*WAI`, `BUSY?`, `*OPC`, and `*OPC?`.

Using the `*WAI` Command

You can force commands to execute sequentially by using the `*WAI` command. This command forces completion of the previous commands before processing new ones.

The same command sequence using the `*WAI` command for synchronization looks like this:

```

/* Set up single-sequence acquisition */
SELECT:CH1 ON
HORIZONTAL:RECORDLENGTH 500
ACQUIRE:MODE NORMALSAMPLE
ACQUIRE:STOPAFTER SEQUENCE
/* Acquire waveform data */
ACQUIRE:STATE ON
/* Set up the measurement parameters */
MEASUREMENT:IMMED:TYPE AMPLITUDE
MEASUREMENT:IMMED:SOURCE CH1
/* Wait until the acquisition is complete before taking the measurement */
*WAI
    
```

```
/* Take amplitude measurement on acquired data */
MEASUREMENT:IMMED:VALUE?
```

Though **WAI* is one of the easiest ways to achieve synchronization, it is also the most costly. The processing time of the digitizing oscilloscope is slowed since it is processing a single command at a time. This time could be spent doing other tasks.

The controller can continue to write commands to the input buffer of the digitizing oscilloscope, but the commands will not be processed by the digitizing oscilloscope until all operations in process are complete. If the input buffer becomes full, the controller will be unable to write more commands to the buffer. This can cause a time-out.

Using the BUSY Query

The *BUSY?* query allows you to find out whether the digitizing oscilloscope is busy processing a command that has an extended processing time such as single-sequence acquisition.

The same command sequence using the *BUSY?* query for synchronization looks like this:

```
/* Set up single-sequence acquisition */
SELECT:CH1 ON
HORIZONTAL:RECORDLENGTH 500
ACQUIRE:MODE NORMALSAMPLE
ACQUIRE:STOPAFTER SEQUENCE
/* Acquire waveform data */
ACQUIRE:STATE ON
/* Set up the measurement parameters */
MEASUREMENT:IMMED:TYPE AMPLITUDE
MEASUREMENT:IMMED:SOURCE CH1
/* Wait until the acquisition is complete before taking the measurement */
While BUSY? keep looping
/* Take amplitude measurement on acquired data */
MEASUREMENT:IMMED:VALUE?
```

This sequence lets you create your own wait loop rather than using the **WAI* command. The *BUSY?* query helps you avoid time-outs caused by writing too many commands to the input buffer. The controller is still tied up, though, and the repeated *BUSY?* query will result in more bus traffic.

Using the *OPC Command

If the corresponding status registers are enabled, the **OPC* command sets the OPC bit in the Standard Event Status Register (SESR) when an operation is complete. You achieve synchronization by using this command with either a serial poll or service request handler.

Serial Poll Method. Enable the OPC bit in the Device Event Status Enable Register (DESER) and the Event Status Enable Register (ESER) using the DESE and *ESE commands. When the operation is complete, the OPC bit in the Standard Event Status Register (SESR) will be enabled and the Event Status Bit (ESB) in the Status Byte Register will be enabled.

The same command sequence using the *OPC command for synchronization with serial polling looks like this:

```

/* Set up single-sequence acquisition */
SELECT:CH1 ON
HORIZONTAL:RECORDLENGTH 500
ACQUIRE:MODE SAMPLE
ACQUIRE:STOPAFTER SEQUENCE
/* Enable the status registers */
DESE 1
*ESE 1
*SRE 0
/* Acquire waveform data */
ACQUIRE:STATE ON
/* Set up the measurement parameters */
MEASUREMENT:IMMED:TYPE AMPLITUDE
MEASUREMENT:IMMED:SOURCE CH1
/* Wait until the acquisition is complete before taking the measurement. */
*OPC
While serial poll = 0, keep looping
/* Take amplitude measurement on acquired data */
MEASUREMENT:IMMED:VALUE?

```

This technique requires less bus traffic than did looping on BUSY?.

Service Request Method. Enable the OPC bit in the Device Event Status Enable Register (DESER) and the Event Status Enable Register (ESER) using the DESE and *ESE commands. You can also enable service requests by setting the ESB bit in the Service Request Enable Register (SRER) using the *SRE command. When the operation is complete, a Service Request will be generated.

The same command sequence using the *OPC command for synchronization looks like this:

```

/* Set up single-sequence acquisition */
SELECT:CH1 ON
HORIZONTAL:RECORDLENGTH 500
ACQUIRE:MODE SAMPLE
ACQUIRE:STOPAFTER SEQUENCE
/* Enable the status registers */
DESE 1

```



```

*ESE 1
*SRE 32
/* Acquire waveform data */
ACQUIRE:STATE ON
/* Set up the measurement parameters */
MEASUREMENT:IMMED:TYPE AMPLITUDE
MEASUREMENT:IMMED:SOURCE CH1
/* Wait until the acquisition is complete before taking the measurement */
*OPC
Program can now do different tasks such as talk to other
devices. The SRQ, when it comes, interrupts those tasks and
returns control to this task.
/* Take amplitude measurement on acquired data */
MEASUREMENT:IMMED:VALUE?

```

This technique is more efficient but requires more sophisticated programming.

Using the *OPC? Query

The *OPC? query places a 1 in the Output Queue once an operation is complete. A timeout could occur if you try to read the output queue before there is any data in it.

The same command sequence using the *OPC? query for synchronization looks like this:

```

/* Set up single-sequence acquisition */
SELECT:CH1 ON
HORIZONTAL:RECORDLENGTH 500
ACQUIRE:MODE SAMPLE
ACQUIRE:STOPAFTER SEQUENCE
/* Acquire waveform data */
ACQUIRE:STATE ON
/* Set up the measurement parameters */
MEASUREMENT:IMMED:TYPE AMPLITUDE
MEASUREMENT:IMMED:SOURCE CH1
/* Wait until the acquisition is complete before taking the measurement */
*OPC?
Wait for read from Output Queue.
/* Take amplitude measurement on acquired data */
MEASUREMENT:IMMED:VALUE?

```

This is the simplest approach. It requires no status handling or loops. However, you must set the controller time-out for longer than the acquisition operation.

Messages

Tables 3–3 through 3–9 list all the programming interface messages the digitizing oscilloscope generates in response to commands and queries.

For most messages, a secondary message from the digitizing oscilloscope gives more detail about the cause of the error or the meaning of the message. This message is part of the message string, and is separated from the main message by a semicolon.

Each message is the result of an event. Each type of event sets a specific bit in the SESR and is controlled by the equivalent bit in the DESER. Thus, each message is associated with a specific SESR bit. In the message tables that follow, the associated SESR bit is specified in the table title, with exceptions noted with the error message text.

Table 3–3 shows the messages when the system has no events or status to report. These have no associated SESR bit.

Table 3–3: No Event Messages

Code	Message
0	No events to report – queue empty
1	No events to report – new events pending *ESR?

Table 3–4 shows the error messages generated by improper command syntax. Check that the command is properly formed and that it follows the rules in *Command Syntax* starting on page 2–1.

Table 3–4: Command Error Messages – CME Bit 5

Code	Message
100	Command error
101	Invalid character
102	Syntax error
103	Invalid separator
104	Data type error
105	GET not allowed
106	Invalid program data separator
108	Parameter not allowed
109	Missing parameter
110	Command header error

Table 3-4: Command Error Messages – CME Bit 5 (Cont.)

Code	Message
111	Header separator error
112	Program mnemonic too long
113	Undefined header
118	Query not allowed
120	Numeric data error
121	Invalid character in number
123	Exponent too large
124	Too many digits
128	Numeric data not allowed
130	Suffix error
131	Invalid suffix
134	Suffix too long
138	Suffix not allowed
140	Character data error
141	Invalid character data
144	Character data too long
148	Character data not allowed
150	String data error
151	Invalid string data
152	String data too long
158	String data not allowed
160	Block data error
161	Invalid block data
168	Block data not allowed
170	Expression error
171	Invalid expression
178	Expression data not allowed
180	Alias error
181	Invalid outside alias definition
183	Invalid inside alias definition
184	Command in alias requires more/fewer parameters

Table 3–5 lists the execution errors that are detected during execution of a command. In these error messages, you should read “macro” as “alias.”

Table 3–5: Execution Error Messages – EXE Bit 4

Code	Message
200	Execution error
201	Invalid while in local
202	Settings lost due to rtl
210	Trigger error
211	Trigger ignored
212	Arm ignored
220	Parameter error
221	Settings conflict
222	Data out of range
223	Too much data
224	Illegal parameter value
230	Data corrupt or stale
240	Hardware error
241	Hardware missing
242	Hardware configuration error
243	Hardware I/O device error
250	Mass storage error
251	Missing mass storage
252	Missing media
253	Corrupt media
254	Media full
255	Directory full
256	File name not found
257	File name error
258	Media protected
260	Expression error
261	Math error in expression
2200	Measurement error, Measurement system error
2201	Measurement error, Zero period
2202	Measurement error, No period found

Table 3-5: Execution Error Messages – EXE Bit 4 (Cont.)

Code	Message
2203	Measurement error, No period, second waveform
2204	Measurement error, Low signal amplitude
2205	Measurement error, Low amplitude, second waveform
2206	Measurement error, Invalid gate
2207	Measurement error, Measurement overflow
2208	Measurement error, Waveform does not cross Mid Ref
2209	Measurement error, No second Mid Ref crossing
2210	Measurement error, No Mid Ref crossing, second waveform
2211	Measurement error, No backwards Mid Ref crossing
2212	Measurement error, No negative crossing
2213	Measurement error, No positive crossing
2214	Measurement error, No crossing
2215	Measurement error, No crossing, second waveform
2216	Measurement error, No crossing, target waveform
2217	Measurement error, Constant waveform
2218	Measurement error, Unused
2219	Measurement error, No valid edge – No arm sample
2220	Measurement error, No valid edge – No arm cross
2221	Measurement error, No valid edge – No trigger cross
2222	Measurement error, No valid edge – No second cross
2223	Measurement error, Waveform mismatch
2224	Measurement error, WAIT calculating
2225	Measurement error, No waveform to measure
2226	Null Waveform
2227	Positive and Negative Clipping
2228	Measurement error, Positive Clipping
2229	Measurement error, Negative Clipping
2230	Measurement error, High Ref < Low Ref
2235	Math error, Invalid math description
2236	Math error, Reference waveform is invalid
2237	Math error, Out of acquisition memory
2240	Invalid password
2241	Waveform requested is invalid

Table 3-5: Execution Error Messages – EXE Bit 4 (Cont.)

Code	Message
2242	Data start and stop > record length
2243	Waveform requested is not a data source
2244	Waveform requested is not turned on
2245	Saveref error, Selected channel is turned off
2246	Saveref error, Selected channel data invalid
2247	Saveref error, Out of reference memory
2248	Saveref error, Source reference data invalid
2249	Reference deletion error, Waveform in use for math
2260	Calibration error
2270	Alias error
2271	Alias syntax error
2272	Alias execution error
2273	Illegal alias label
2274	Alias parameter error
2275	Alias definition too long
2276	Alias expansion error
2277	Alias redefinition not allowed
2278	Alias header not found
2279	Alias label too long
2280	Alias table full
2285	TekSecure® Pass
2286	TekSecure® Fail
2290	Limit error, Reference in use
2291	Limit error, Reference data invalid
2292	Limit error, Out of reference memory
2293	Limit error, Selected channel is turned off
2301	Cursor error, Off-screen
2302	Cursor error, cursors in different frames
2311	Group requested has not been selected or has been deleted

Table 3–6 lists the device errors that can occur during digitizing oscilloscope operation. These errors may indicate that the oscilloscope needs repair.

Table 3–6: Device Error Messages – DDE Bit 3

Code	Message
300	Device-specific error
310	System error
311	Memory error
312	PUD memory lost
313	Calibration memory lost
314	Save/recall memory lost
315	Configuration memory lost
350	Queue overflow (does not set DDE bit)

Table 3–7 lists the system event messages. These messages are generated whenever certain system conditions occur.

Table 3–7: System Event Messages

Code	Message
400	Query event
401	Power on (PON bit 7 set)
402	Operation complete (OPC bit 0 set)
403	User request (URQ bit 6 set)
404	Power fail (DDE bit 3 set)
405	Request control
410	Query INTERRUPTED (QYE bit 2 set)
420	Query UNTERMINATED (QYE bit 2 set)
430	Query DEADLOCKED (QYE bit 2 set)
440	Query UNTERMINATED after indefinite response (QYE bit 2 set)
450	Right menu button #1 pushed (URQ bit 6 set)
451	Right menu button #2 pushed (URQ bit 6 set)
452	Right menu button #3 pushed (URQ bit 6 set)
453	Right menu button #4 pushed (URQ bit 6 set)
454	Right menu button #5 pushed (URQ bit 6 set)
460	Bottom menu button #1 pushed (URQ bit 6 set)

Table 3–7: System Event Messages (Cont.)

Code	Message
461	Bottom menu button #2 pushed (URQ bit 6 set)
462	Bottom menu button #3 pushed (URQ bit 6 set)
463	Bottom menu button #4 pushed (URQ bit 6 set)
464	Bottom menu button #5 pushed (URQ bit 6 set)
465	Bottom menu button #6 pushed (URQ bit 6 set)
466	Bottom menu button #7 pushed (URQ bit 6 set)

Table 3–8 lists warning messages that do not interrupt the flow of command execution. These notify you that you may get unexpected results.

Table 3–8: Execution Warning Messages – EXE Bit 4

Code	Message
500	Execution warning
510	String data too long, truncated
525	Parameter underrange
526	Parameter overrange
527	Parameter rounded
528	Parameter out of range
530	Data stop > stop, Values swapped internally
531	Data stop > record length, Curve truncated
532	Curve data too long, Curve truncated
540	Measurement warning
541	Measurement warning, Low signal amplitude
542	Measurement warning, Unstable histogram
543	Measurement warning, Low resolution
544	Measurement warning, Uncertain edge
545	Measurement warning, Invalid in minmax
546	Measurement warning, Need 3 edges
547	Measurement warning, Clipping positive/negative
548	Measurement warning, Clipping positive
549	Measurement warning, Clipping negative

Table 3–8: Execution Warning Messages – EXE Bit 4 (Cont.)

Code	Message
550	InstaVu active – deactivate to see change
551	InstaVu active – deactivate to use math

Table 3–9 shows internal errors that indicate an internal fault in the digitizing oscilloscope.

Table 3–9: Internal Warning Messages

Code	Message
600	Internal warning
620	Internal warning, Bad thermistor
630	Internal warning, 50 Ω overload

Programming Examples

The example programs illustrate methods you can use to control the digitizing oscilloscope from the GPIB interface. The diskettes that come with this manual contain listings for these programs written in Microsoft QuickBASIC 4.5 and Microsoft QuickC 2.5.

The programs run on a PC-compatible system equipped with a Tektronix (National Instruments) GPIB board and associated drivers. For example, the programs will work with a Tektronix S3FG210 (National Instruments GPIB-PCII/IIA) GPIB package (See Figure 4–1).

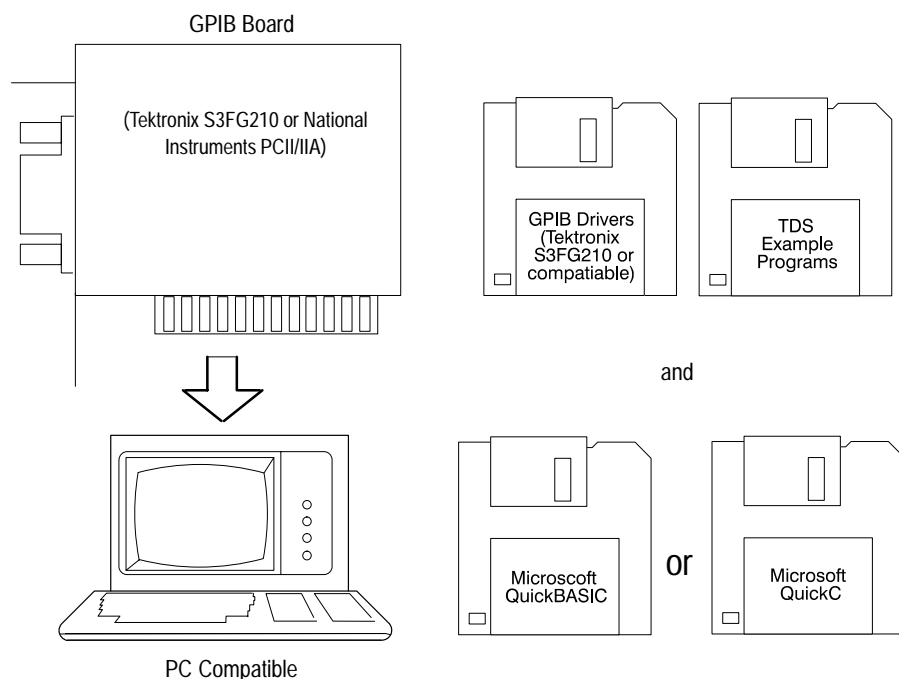

Figure 4–1: Equipment Needed to Run the Example Programs

All the example programs assume that the GPIB system recognizes the digitizing oscilloscope as DEV1 and the PC (controller) as GPIB0. You can use the IBCNF.EXE program to assign these names.

The example software includes:

- MEAS: automatically measures waveform parameters.
- COMM: shows communication between controller and oscilloscope.

- GETWFM: reads a waveform from an oscilloscope and stores it in a file.
- CURSOR: uses cursors to measure waveform parameters.
- TL: a talker-listener program.

Compiling the Example Programs

The example programs diskette contains programs written in Microsoft QuickBASIC 4.5 and Microsoft QuickC 2.5.

Executable versions of the programs are in the PROGRAMS directory. Source versions are in the SOURCES directory. Within this directory, the QuickBASIC programs are in the Q-BASIC subdirectory and the QuickC programs are in the QUICK-C subdirectory.

A README file in each directory explains how to build executable code from the source files provided.

The QuickC directory also comes with sample MAKE files and sample executable files. These have the suffix .MAK.

If you wish to develop code, you will need to use files that come with the GPIB system. Specifically, the QuickBASIC programs use QBDECL.BAS and QBIB.OBJ. The QuickC programs use DECL.H and MCIB.OBJ.

NOTE. *The programs you compile in the Sources directory work with the Tektronix S3FG210 (National Instruments GPIB-PCII-IIA) GPIB system. It may take extra steps or changes to get them to work with older Tektronix GURU and other GPIB systems.*

Compiling and Linking Your Example Quick-C Programs

To make an executable for any example, perform the following:

1. Install QuickC. Select the SMALL memory model. Be sure to set up your path so DOS can access the QuickC directory.
2. Install the Tektronix S3FG210 (National Instruments GPIB-PCII-IIA) GPIB board and drivers. Remember to identify the GPIB device as DEV1. You can use the IBCONF.EXE program to do this.
3. Copy the files from the examples diskette to your hard disk. You might also create a special directory to store them. For example, if the current drive is hard disk C, you want to store the examples in drive C, and the examples diskette is in drive B, you might type:

```
mkdir examples
```

```
cd examples
```

```
copy B:\quick-c\*. * .
```

4. For this installation, you will also want to copy DECL.H and MCIB.OBJ from your Tektronix S3FG210 (National Instruments GPIB-PCII/IIA) GPIB drivers directory to this directory. For example, if the GPIB drivers are in the gpib-pc directory and you are in the example programs directory, you would type:

```
copy \gpib-pc\decl.h .
```

```
copy \gpib-pc\mcib.obj .
```

5. To compile and link your TDS sample C programs, simply type: nmake <file name>.mak

where <file name> refers to the name of the example program you wish to compile and link. Specifically:

To compile and link MEAS.C, type: nmake meas.mak

To compile and link COMM.C, type: nmake comm.mak

To compile and link GETWFM.C, type: nmake getwfm.mak

To compile and link CURSOR.C, type: nmake cursor.mak

To compile and link TL.C, type: nmake t1.mak

6. Run the program by simply typing the program name.

To run meas, type: meas

To run comm, type: comm

To run getwfm, type: getwfm

To run cursor, type: cursor

To run t1, type: t1

Compiling and Linking Your Example QuickBASIC Programs

To make an executable for any of the following files, perform the following:

1. Install QuickBASIC.
2. Install the Tektronix S3FG210 (National Instruments GPIB-PCII/IIA) GPIB board and drivers. Remember to reboot your PC to initialize the GPIB drivers.
3. Copy the files from the examples diskette to your hard disk. You might also create a special directory to store them. For example, if the current drive is

hard disk C, you want to store the examples in drive C, and the examples diskette is in drive B, you might type:

```
mkdir examples
cd examples
copy b:\q-basic\*. * .
```

4. For this installation, you will also want to copy QBDECL.BAS and QBIB.OBJ from your Tektronix S3FG210 (National Instruments GPIB-PCII/IIA) GPIB drivers directory to the directory your example programs are in. For example, if the GPIB drivers are in the `gpiB-pc` directory and you are in the example programs directory, you would type:

```
copy \gpiB-pc\qbdecl.bas .
copy \gpiB-pc\qbib.obj .
```

5. Perform the following two steps for example programs:
 - a. Compile the program by using the following command:

```
bc /o <file>.bas;
```

where `<file>` is one of the example program names.

To compile MEAS.BAS, type: `bc /o meas.bas;`

To compile COMM.BAS, type: `bc /o comm.bas;`

To compile GETWFM.BAS, type: `bc /o getwfm.bas;`

To compile CURSOR.BAS, type: `bc /o cursor.bas;`

To compile TL.BAS, type: `bc /o tl.bas;`

- b. Link the compiled program with the `qbib.obj` module to create the executable program (file.EXE) by using the following command:

```
link <file>.obj+qbib.obj;
```

where `<file>` is one of the above program names.

To link MEAS.OBJ, type: `link meas.obj+qbib.obj;`

To link COMM.OBJ, type: `link comm.obj+qbib.obj;`

To link GETWFM.OBJ, type: `link getwfm.obj+qbib.obj;`

To link CURSOR.OBJ, type: `link cursor.obj+qbib.obj;`

To link TL.OBJ, type: `link tl.obj+qbib.obj;`

GPIBIO.BAS is a collection of input/output routines used by the other programs and is included for proper file compilation.

6. Run the program by simply typing the program name.

To run meas, type: meas

To run comm, type: comm

To run getwfm, type: getwfm

To run cursor, type: cursor

To run t1, type: t1

NOTE. *The example programs disable front-panel operation while they are running and reenables it when they terminate. If your program terminates prematurely, front-panel operation may remain disabled. To reenables front-panel operation, do one of the following: cycle power on the digitizing oscilloscope or send the GPIB command UNLOCK ALL to unlock the front panel. You can send the UNLOCK ALL command with the TL program included in your sample programs disk.*

Appendix A: Character Charts

The characters in Table A-1 are available for the digitizing oscilloscope. Numbers in the lower left corners are character widths in pixels.

Table A-1: The TDS Character Set

	0	1	2	3	4	5	6	7
0	NUL 0 0	√ 12 16	space 5 32	0 10 48	@ 14 64	P 10 80	' 5 96	p 11 112
1	— 251 1	Ω 14 17	! 5 33	1 10 49	A 12 65	Q 13 81	a 8 97	q 10 113
2	¿ 7 2	Δ 15 18	" 7 34	2 10 50	B 10 66	R 10 82	b 11 98	r 7 114
3	Ç 8 3	BW 11 19	# 10 35	3 10 51	C 10 67	S 9 83	c 8 99	s 8 115
4	.. 10 4	∫ 12 20	\$ 10 36	4 10 52	D 12 68	T 10 84	d 10 100	t 7 116
5	` 10 5	∖ 12 21	% 12 37	5 10 53	E 9 69	U 12 85	e 9 101	u 11 117
6	ƒ 12 6	μ 12 22	& 12 38	6 10 54	F 9 70	V 11 86	f 6 102	v 10 118
7	' 5 7	˘ 10 23	' 5 39	7 10 55	G 11 71	W 15 87	g 10 103	w 14 119
8	i 5 8	— 16 24	(6 40	8 10 56	H 13 72	X 10 88	h 11 104	x 9 120
9	HT 0 9	— 16 25) 6 41	9 10 57	I 6 73	Y 10 89	i 5 105	y 10 121
A	LF 0 10	∞ 12 26	* 8 42	: 6 58	J 7 74	Z 10 90	j 5 106	z 8 122
B	' 10 11	ESC 0 27	+ 11 43	; 6 59	K 10 75	[6 91	k 10 107	{ 6 123
C	± 11 12	¯ 9 28	' 6 44	< 11 60	L 8 76	∖ 9 92	l 5 108	l 6 124
D	CR 0 13	≠ 11 29	— 11 45	= 11 61	M 15 77] 6 93	m 15 109	} 6 125
E	— 10 14	~ 10 30	· 6 46	> 11 62	N 13 78	^ 11 94	n 11 110	~ 11 126
F	● 7 15	° 10 31	/ 9 47	? 7 63	O 13 79	— 11 95	o 10 111	 3 127

Table A-2: ASCII & GPIB Code Chart

B7 B6 B5 BITS B4 B3 B2 B1	0 0 0	0 0 1	0 1 0	0 1 1	1 0 0	1 0 1	1 1 0	1 1 1		
	CONTROL		NUMBERS SYMBOLS		UPPER CASE		LOWER CASE			
0 0 0 0	0 NUL 0	20 DLE 10 16	40 SP 20 32	60 LA16 30 48	100 TA0 40 64	120 TA16 50 80	140 SA0 60 96	160 SA16 70 112		
0 0 0 1	1 GTL 1 SOH 1	21 LLO 11 DC1 17	41 LA1 21 33	61 LA17 31 49	101 TA1 41 65	121 TA17 51 81	141 SA1 61 97	161 SA17 71 113		
0 0 1 0	2 STX 2	22 DC2 12 18	42 LA2 22 34	62 LA18 32 50	102 TA2 42 66	122 TA18 52 82	142 SA2 62 98	162 SA18 72 114		
0 0 1 1	3 ETX 3	23 DC3 13 19	43 LA3 23 35	63 LA19 33 51	103 TA3 43 67	123 TA19 53 83	143 SA3 63 99	163 SA19 73 115		
0 1 0 0	4 SDC 4 EOT 4	24 DCL 14 DC4 20	44 LA4 24 36	64 LA20 34 52	104 TA4 44 68	124 TA20 54 84	144 SA4 64 100	164 SA20 74 116		
0 1 0 1	5 PPC 5 ENQ 5	25 PPU 15 NAK 21	45 LA5 25 37	65 LA21 35 53	105 TA5 45 69	125 TA21 55 85	145 SA5 65 101	165 SA21 75 117		
0 1 1 0	6 ACK 6	26 SYN 16 22	46 LA6 26 38	66 LA22 36 54	106 TA6 46 70	126 TA22 56 86	146 SA6 66 102	166 SA22 76 118		
0 1 1 1	7 BEL 7	27 ETB 17 23	47 LA7 27 39	67 LA23 37 55	107 TA7 47 71	127 TA23 57 87	147 SA7 67 103	167 SA23 77 119		
1 0 0 0	10 GET 8 BS 8	30 SPE 18 CAN 24	50 LA8 28 40	70 LA24 38 56	110 TA8 48 72	130 TA24 58 88	150 SA8 68 104	170 SA24 78 120		
1 0 0 1	11 TCT 9 HT 9	31 SPD 19 EM 25	51 LA9 29 41	71 LA25 39 57	111 TA9 49 73	131 TA25 59 89	151 SA9 69 105	171 SA25 79 121		
1 0 1 0	12 LF A 10	32 SUB 1A 26	52 LA10 2A 42	72 LA26 3A 58	112 TA10 4A 74	132 TA26 5A 90	152 SA10 6A 106	172 SA26 7A 122		
1 0 1 1	13 VT B 11	33 ESC 1B 27	53 LA11 2B 43	73 LA27 3B 59	113 TA11 4B 75	133 TA27 5B 91	153 SA11 6B 107	173 SA27 7B 123		
1 1 0 0	14 FF C 12	34 FS 1C 28	54 LA12 2C 44	74 LA28 3C 60	114 TA12 4C 76	134 TA28 5C 92	154 SA12 6C 108	174 SA28 7C 124		
1 1 0 1	15 CR D 13	35 GS 1D 29	55 LA13 2D 45	75 LA29 3D 61	115 TA13 4D 77	135 TA29 5D 93	155 SA13 6D 109	175 SA29 7D 125		
1 1 1 0	16 SO E 14	36 RS 1E 30	56 LA14 2E 46	76 LA30 3E 62	116 TA14 4E 78	136 TA30 5E 94	156 SA14 6E 110	176 SA30 7E 126		
1 1 1 1	17 SI F 15	37 US 1F 31	57 LA15 2F 47	77 UNL 3F 63	117 TA15 4F 79	137 UNT 5F 95	157 SA15 6F 111	177 RUBOUT (DEL) 7F 127		
	ADDRESSED COMMANDS		UNIVERSAL COMMANDS		LISTEN ADDRESSES		TALK ADDRESSES		SECONDARY ADDRESSES OR COMMANDS	

KEY

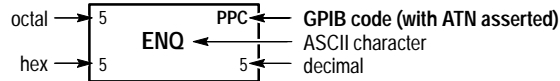

Tektronix

REF: ANSI STD X3.4-1977
IEEE STD 488.1-1987
ISO STD 646-2973

Appendix B: Reserved Words

The following is a list of the reserved words of the digitizing oscilloscope. Do not use these words for aliases. Capital letters identify the required minimum spelling. Hint: Use the full spelling for the most robust code as the minimum spelling rules may change over time and from model to model.

*CAL	BACKGround	CLEARSNapshot	DISPlay
*CLS	BACKWards	CLEARSpool	DOTs
*DDT	BANdwidth	CLOCK	DPU411
*ESE	BASe	CMEan	DPU412
*ESR	BAUd	COLLision	DUAI
*IDN	BELI	COLOr	ECL
*LRN	BIN	COMPARE	EDGE
*OPC	BIT_Nr	CONTRast	EDGE1
*PSC	BLAckman	CONTROI	EDGE2
*PUD	BMP	COPy	EITHer
*RCL	BMPCOLOR	COUNT	ENCdg
*RST	BN_Fmt	COUPling	ENV
*SAV	BOLd	CPU	ENVELOpe
*SRE	BOTH	CRMs	EPSColor
*STB	BOTTOM1	CROSSHair	EPSCOLmg
*TRG	BOTTOM2	CRVchk	EPSImage
*TST	BOTTOM3	CURRent	EPSMono
*WAI	BOTTOM4	CURSor	EPSON
ABOrt	BOTTOM5	CURSOR1	EVEN
ABSolute	BOTTOM6	CURSOR2	EVENT
AC	BOTTOM7	CURVe	EVENTS
ACCept	BOX	CUSTom	EVENTSTime
ACQuire	BURst	CWD	EVMsg
ACQUISition	BUSY	DATA	EVQty
ACTivate	BY	DATE	EXECute
ACTUAl	BYCONTents	DC	FACTory
ALlAs	BYT_Nr	DEFAult	FALL
ALL	BYT_Or	DEFINE	FALSe
ALLEv	CALibrate	DELay	FASTERthan
ALLOcate	CATalog	DELAYEd	FASTframe
AMPLitude	CAREa	DELEte	FFT
AND	CENtronicS	DELTA	FIELD
APPMenu	CH1	DELTATime	FIELD1
AREa	CH2	DELWarn	FIELD2
ARMed	CH3	DESE	FIELDEither
ASC	CH4	DESKJet	FIELDRATE
ASCLi	CHKsm0	DESTination	FIELDS
AUTO	CLAss	DIAG	FIELDType
AUTOSet	CLEAr	DIR	FIFTy
AUXiliary	CLEARMenu	DIREction	
AVErage			

Appendix B: Reserved Words

FILEName	INTENSIFied	NANd	PROcEssing
FILESystem	INTENSITy	NDUty	PT_Fmt
FILTer	INTERLAcE	NEGAtive	PT_Off
FIRSt	INTERLeaf	NEGSynchwidth	PULse
FITtoscreen	INVert	NEWpass	PWIdth
FLAg	IRE	NOISErej	RATE1
FLEXformat	LABel	NONe	RATE2
FORCe	LANdscAPE	NOR	RATE3
FORMat	LASERJet	NORMal	RATE4
FORWards	LAYout	NOVershoot	REAdy
FPANel	LENGth	NR_Pt	RECAIl
FRAMe	LESSLimit	NTSc	RECOrdlength
FREE	LESSThan	NUMACq	RECTangular
FREEspace	LEVel	NUMAVg	REF
FREQuency	LFRej	NUMEnv	REF1
FULI	LIMit	NUMERic	REF2
FUNCTion	LINE	NWIdth	REF3
GATing	LINES	ODD	REF4
GLItch	LINEAr	OFF	REFLevel
GND	LIVe	OFFSet	REGular
GPIb	LOCK	ON	REJect
GRAticule	LOG	ONCe	REM
GRAYscale	LOGIc	OR	REName
GRId	LONG	OPTion	REPEt
HALt	LOW	OUTside	RESET
HAMming	LOWLimit	OVERAll	RESETAll
HARDCopy	LSB	OVERWrite	RESUlT
HARDFlagging	MAIn	PALred	RI
HBArS	MAP	PAL	RIBinary
HDELTA	MATH	PALEtte	RIGHT1
HDR	MATH1	PARity	RIGHT2
HDTv	MATH2	PARTial	RIGHT3
HEADer	MATH3	PASSWord	RIGHT4
HERtz	MAXimum	PATtern	RIGHT5
HFRej	MAXRate	PCX	RISe
HIGH	MEAN	PCXCOLOR	RLE
HIGHLimit	MEAS1	PDUty	RMDir
HIRes	MEAS2	PEAKdetect	RMS
HIStoqram	MEAS3	PERCent	ROLL
HOLDoff	MEAS4	PERIod	RP
HOLDTime	MEASurement	PERSistence	RPBinary
HORizontal	MEG	PHAsE	RS232
HPGI	MESSage	PK2pk	RUN
HPOS1	METHod	POLarity	RUNSAfter
HPOS2	MID	PORT	RUNSTop
HUNdred	MID2	PORTrait	RUNT
ID	MINimum	POSition	SAMple
IMMed	MINMax	POSITION1	SAVe
IMPedance	MKDir	POSITION2	SCAle
INDependent	MODE	POSITIVe	SCAN
INFINite	MONo	POVershoot	SCANPeriod
INFPersist	MORELimit	PREView	SCROLLBAR
INIT	MOREThan	PRInt	SCROLLTEXT
INPut	MSB		
NS...	NUM		

SECAm	STANdard	TRIGger	WFId
SECdiv	START	TRIGT	WFMPre
SECOnds	STATE	TRUe	WHEn
SELEct	STOP	TTL	WIDth
SEQUence	STOPAfter	TWEnty	WIThin
SET	STOPBits	TWOifty	X
SETHold	STORe	TYPe	XINcr
SETLevel	STYle	UNITS	XMUlt
SETTime	SYNc	UNITSTring	XOFF
SETUp	SYStem	UNLock	XUNit
SHORt	TARget	VALue	XY
SHOW	TEKSecure	VARpersist	XZEro
SINX	TEMPErature	VBArs	Y
SLEWRate	TEMPLate	VDELTA	YMUlt
SLOpe	TEXT	VECTors	YOFF
SLOWERthan	THInkjet	VERBose	YT
SNAP	THReshold	VERTical	YUNit
SNAPShot	TIFf	VIDeo	YZEro
SOFTFlagging	TIMe	VOLts	ZMUlt
SOUrce	TITLe	V1STArttime	ZOFF
SOURCE1	TO	V1STOptime	ZONe
SOURCE2	TOLerance	V2STArttime	ZOOM
SPECTral	TRACk	V2STOptime	ZUNit
SRIbinary	TRIGAAfter	WAVEform	ZZEro
SRPbinary	TRIGBar	WAVFrm	

Appendix C: Interface Specifications

This appendix describes details of the GPIB remote interface of the digitizing oscilloscope. Normally, you will not need this information to use the digitizing oscilloscope, but the information is useful when connecting to controllers of unusual configuration.

GPIB Function Subsets

The digitizing oscilloscope supports many GPIB function subsets, as listed below. Some of the listings describe subsets that the digitizing oscilloscope does not support.

- SH1 (Source Handshake). The digitizing oscilloscope can transmit multiline messages across the GPIB.
- AH1 (Acceptor Handshake). The digitizing oscilloscope can receive multiline messages across the GPIB.
- T5 (Talker). The digitizing oscilloscope becomes a talker when its talk address is sent with the ATN (Attention) line asserted. It can send both response data and status information when responding to a serial poll. It ceases to be a talker when the talk address of another device is sent with ATN asserted. The digitizing oscilloscope has talk-only capability for hardcopy operation.
- L4 (Listener). The digitizing oscilloscope becomes a listener when its listen address is sent with the ATN (Attention) line asserted. The digitizing oscilloscope does not have listen-only capability.
- SR1 (Service Request). The digitizing oscilloscope asserts an SRQ (Service Request) line to notify the controller when it requires service.
- RL1 (Remote/Local). The digitizing oscilloscope responds to both the GTL (Go To Local) and LLO (Local Lock Out) interface messages.
- PP0 (Parallel Poll). The digitizing oscilloscope has no parallel poll capability. It does not respond to the following interface messages: PPC, PPD, PPE, and PPU. The digitizing oscilloscope does not send out a status message when the ATN (Attention) and EOI (End or Identify) lines are asserted simultaneously.
- DC1 (Device Clear). The digitizing oscilloscope responds to the DCL (Device Clear) and, when made a listener, the SDC (Selected Device Clear) interface messages.

- DT1 (Device Trigger). When acting as a listener, the digitizing oscilloscope responds to the GET (Group Execute Trigger) interface message.
- C0 (Controller). The digitizing oscilloscope cannot control other devices.
- E2 (Electrical). The digitizing oscilloscope uses tristate buffers to provide optimal high-speed data transfer.

Interface Messages

Table C–1 shows the standard interface messages that are supported by the digitizing oscilloscope.

Table C–1: TDS Family Oscilloscope Standard Interface Message

Message	GPIB
DCL	Yes
GET	Yes
GTL	Yes
LLO	Yes
PPC	No
PPD	No
PPE	No
PPU	No
SDC	Yes
SPD	Yes
SPE	Yes
TCT	No
UNL	Yes
UNT	Yes
Listen Addresses	Yes
Talk Addresses	Yes

Appendix D: Factory Initialization Settings

The factory initialization settings provide you a known state for the digitizing oscilloscope.

Factory initialization sets values as shown in Table D–1.

Table D–1: Factory Initialization Settings

Control	Changed by Factory Init to
Acquire mode	Sample
Acquire repetitive signal (TDS 4XXA, 5XXA, & 7XXA)	ON (Enable ET)
Acquire stop after	RUN/STOP button only
Acquire # of averages	16
Acquire # of envelopes	10
Channel selection	Channel 1 on, all others off
Cursor H Bar 1 position	10% of graticule height (–3.2 divs from the center)
Cursor H Bar 2 position	90% of the graticule height (+3.2 divs from the center)
Cursor V Bar 1 position	10% of the record length
Cursor V Bar 2 position	90% of the record length
Cursor amplitude units	Base
Cursor function	Off
Cursor mode	Independent
Cursor time units	Seconds
Date and time	No change
Delay events, triggerable after main	TDS 4XXA: 1 TDS 5XXA, 6XXA, & 7XXA: 2
Delay time, delayed runs after main	TDS 4XXA: 10 ns TDS 5XXA, 6XXA, & 7XXA: 16 ns
Delay time, delayed triggerable after main	TDS 4XXA: 60 ns TDS 5XXA, 6XXA, & 7XXA: 16 ns
Delay trigger average #	16
Delay trigger envelope #	10
Delayed, delay by ...	Delay by Time

Table D-1: Factory Initialization Settings (Cont.)

Control	Changed by Factory Init to
Delayed edge trigger coupling All except TDS 684A & 7XXA	DC Main Trigger
Delayed edge trigger level	0 V
Delayed edge trigger slope	Rising
Delayed edge trigger source	Channel 1
Delayed, time base mode	Delayed Runs After Main
Display clock	No Change
Display color – collision contrast (TDS 524A, 544A, 644A, 684A, & 7XXA)	Off
Display color – map math colors (TDS 524A, 544A, 644A, 684A, & 7XXA)	Color 'Math'
Display color – map reference colors (TDS 524A, 544A, 644A, 684A, & 7XXA)	Color 'Ref'
Display color – palette (TDS 524A, 544A, 644A, 684A, & 7XXA)	Normal
Display color – palette colors (TDS 524A, 544A, 644A, 684A, & 7XXA)	All palette colors are reset to factory hue, saturation, and lightness (HLS) values
Display color – persistence palette (TDS 524A, 544A, 644A, 684A, & 7XXA)	Temperature
Display format	YT
Display graticule type	Full
Display instavu persistence	Varpersist
Display instavu style	Vectors
Display instavu varpersist	500 e-3
Display intensity – contrast (TDS 4XXA, 5X0A, & 6X0A)	150%
Display intensity – text	TDS 524A, 544A, 644A, 684A, & 7XXA: 100% TDS 4XXA, 520A, & 540A, 620A, & 640A: 60%
Display intensity – waveform	TDS 524A, 544A, 644A, 684A, & 7XXA: 100% TDS 4XXA, 520A, 540A, 620A, & 640A: 75%
Display intensity – overall (TDS 4XXA, 5X0A, & 6X0A)	85%
Display interpolation filter	Sin(x)/x
Display mode	Normal
Display style	Vectors
Display trigger bar style	Short

Table D-1: Factory Initialization Settings (Cont.)

Control	Changed by Factory Init to
Display trigger "T"	On
Display variable persistence	500 ms
Edge trigger coupling	DC
Edge trigger level	0.0 V
Edge trigger slope	Rising
Edge trigger source	Channel 1
GPIB parameters	No change
Hardcopy Format	Unchanged
Layout	Unchanged
Palette	Unchanged
Port	Unchanged
Horizontal – delay time/division	50 μ s
Horizontal – delay trigger position	50%
Horizontal – delay trigger record length	500 points (10 divs)
Horizontal – fit to screen	Off
Horizontal – FastFrame (TDS 520A, 524A, 540A, 544A, & 7XXA)	Off
Horizontal – FastFrame, frame count (TDS 520A, 524A, 540A, 544A, & 7XXA)	2
Horizontal – FastFrame, frame length (TDS 520A, 524A, 540A, 544A, & 7XXA)	500
Horizontal – main time/division	500 μ s
Horizontal – main trigger position	50%
Horizontal – main trigger record length	500 points (10 divs)
Horizontal – time base	Main only
Limit template \pm V Limit	40 mdiv
\pm H Limit	40 mdiv
Limit template destination	Ref1
Limit template source	Ch1
Limit test sources	Ch1 compared to Ref1; all others compared to none.
Limit Testing	Off
Limit Testing – hardcopy if condition met	Off
Limit Testing – ring bell if condition met	Off
Logic pattern trigger Ch4 (Ax2) input (TDS 5XXA, 6XXA, & 7XXA)	X (do not care)

Table D-1: Factory Initialization Settings (Cont.)

Control	Changed by Factory Init to
Logic state trigger Ch4 (Ax2) input (TDS 5XXA, 6XXA, & 7XXA)	Rising edge
Logic trigger input (pattern and state) (TDS 5XXA, 6XXA, & 7XXA)	Channel 1 = H (high), Channels 2 & 3 (Ax1) = X (do not care)
Logic trigger pattern time qualification Lower limit Upper limit (TDS 5XXA, 6XXA, & 7XXA)	5 ns 5 ns
Logic trigger sources and levels (Setup/Hold) (TDS 684A & 7XXA)	Data Source = Channel 1 = 1.4 V Clock Source = Channel 2 = 1.4 V (Source levels are clipped to 1.2 V at the default volts/division setting established by Factory Init) Clock Edge = Rising
Logic trigger threshold (all channels) (pattern and state) (TDS 5XXA, 6XXA, & 7XXA)	1.4 V (when 10X probe attached)
Logic trigger class (TDS 5XXA, 6XXA, & 7XXA)	Pattern
Logic trigger logic (pattern and state) (TDS 5XXA, 6XXA, & 7XXA)	AND
Logic trigger triggers when ... (pattern and state) (TDS 5XXA, 6XXA, & 7XXA)	Goes TRUE
Main trigger holdoff	0%
Main trigger mode	Auto
Main trigger type	Edge
Math1 definition	Ch 1 + Ch 2
Math1 extended processing (TDS 5XXA, 6XXA, & 7XXA)	No extended processing
Math2 definition	Ch 1 – Ch 2 (FFT of Ch 1 for instruments with Option 2F Advanced DSP Math)
Math2 extended processing (TDS 5XXA, 6XXA, & 7XXA)	No extended processing
Math3 definition	Inv of Ch 1
Math3 extended processing (TDS 5XXA, 6XXA, & 7XXA)	No extended processing

Table D-1: Factory Initialization Settings (Cont.)

Control	Changed by Factory Init to
Measure Delay edges	Both rising and forward searching
Measure Delay to	Channel 1 (Ch1)
Measure Gating	Off
Measure High Ref	90% and 0 V (units)
Measure High-Low Setup	Histogram
Measure Low Ref	10% and 0 V (units)
Measure Mid Ref	50% and 0 V (units)
Measure Mid2 Ref	50% and 0 V (units)
Pulse glitch filter state (TDS 5XXA, 6XXA, & 7XXA)	On (Accept glitch)
Pulse glitch trigger polarity (TDS 5XXA, 6XXA, & 7XXA)	Positive
Pulse glitch width (TDS 5XXA, 6XXA, & 7XXA)	2.0 ns
Pulse runt high threshold (TDS 5XXA, 6XXA, & 7XXA)	1.2 V
Pulse runt low threshold (TDS 5XXA, 6XXA, & 7XXA)	0.8 V
Pulse runt trigger polarity (TDS 5XXA, 6XXA, & 7XXA)	Positive
Pulse slew rate Delta Time	2.0 ns
Pulse slew rate polarity	Positive
Pulse slew rate setting	
Pulse slew rate thresholds Upper Lower	Trig if faster than 1.80 V 800 mV
Pulse slew rate triggers when ...	Trig if faster than
Pulse trigger class (TDS 5XXA, 6XXA, & 7XXA)	Glitch
Pulse trigger level (TDS 5XXA, 6XXA, & 7XXA)	0.0 V
Pulse trigger source (Glitch, runt, and width) (TDS 5XXA, 6XXA, & 7XXA)	Channel 1 (Ch1)
Pulse width lower limit (TDS 5XXA, 6XXA, & 7XXA)	2.0 ns

Table D-1: Factory Initialization Settings (Cont.)

Control	Changed by Factory Init to
Pulse width trigger polarity (TDS 5XXA, 6XXA, & 7XXA)	Positive
Pulse width trigger when ... (TDS 5XXA, 6XXA, & 7XXA)	Within limits
Pulse width upper limit (TDS 5XXA, 6XXA, & 7XXA)	2.0 ns
RS-232 parameters	No change
Saved setups	No change
Saved waveforms	No change
Stop after	R/S button
Vertical bandwidth (all channels)	Full
Vertical coupling (all channels)	DC
Vertical impedance (termination) (all channels)	1 M Ω
Vertical offset (all channels)	0 V
Vertical position (all channels)	0 divs.
Vertical volts per division (all channels)	100 mV per division
Zoom dual	Off
Zoom dual offset	5 e-3
Zoom graticule	Upper
Zoom horizontal (all channels)	1.0X
Zoom horizontal lock	All
Zoom horizontal position (all channels)	50% = 0.5 (the middle of the display)
Zoom state	Off
Zoom vertical (all channels)	1.0X
Zoom vertical position (all channels)	0 divs.

Glossary

ASCII

Acronym for the American Standard Code for Information Interchange. Controllers transmit commands to the digitizing oscilloscope using ASCII character encoding.

Address

A 7-bit code that identifies an instrument on the communication bus. The digitizing oscilloscope must have a unique address for the controller to recognize and transmit commands to it.

Backus-Naur Form (BNF)

A standard notation system for command syntax diagrams. The syntax diagrams in this manual use BNF notation.

Controller

A computer or other device that sends commands to and accepts responses from the digitizing oscilloscope.

EOI

A mnemonic referring to the control line “End or Identify” on the GPIB interface bus. One of the two possible end-of-message terminators.

EOM

A generic acronym referring to the end-of-message terminator. The end-of-message terminator can be either an EOI or the ASCII code for line feed (LF).

Equivalent-time sampling (ET)

A sampling mode in which the oscilloscope acquires signals over many repetitions of the event. The TDS Family Series Digitizing Oscilloscopes use a type of equivalent time sampling called *random equivalent time sampling*. It utilizes an internal clock that runs asynchronously with respect to the input signal and the signal trigger. The oscilloscope takes samples continuously, independent of the trigger position, and displays them based on the time difference between the sample and the trigger. Although the samples are taken sequentially in time, they are random with respect to the trigger.

Real-time sampling

A sampling mode where the digitizing oscilloscope samples fast enough to completely fill a waveform record from a single trigger event. Use real-time sampling to capture single-shot or transient events.

GPIB

Acronym for General Purpose Interface Bus, the common name for the communications interface system defined in IEEE Std 488.

IEEE

Acronym for the Institute for Electrical and Electronic Engineers.

QuickBASIC

A computer language (distributed by Microsoft) that is based on the Beginner's All-Purpose Symbolic Instruction Code.

QuickC

A computer language (distributed by Microsoft) that is based on C.

TEKSecure

A Tektronix custom command that initializes both waveform and setup memories. This overwrites any previously stored data.

Index

A

Abbreviating, command, 2-4
ACQUIRE?, 2-39
ACQUIRE:AUTOSAVE, 2-39
ACQUIRE:MODE, 2-40
ACQUIRE:NUMACQ?, 2-42
ACQUIRE:NUMAVG, 2-43
ACQUIRE:NUMENV, 2-43
ACQUIRE:REPET, 2-44
ACQUIRE:STATE, 2-45
ACQUIRE:STOPAFTER, 2-46
Acquisition command group, 2-11, 2-12
Acquisition commands
 ACQUIRE?, 2-39
 ACQUIRE:AUTOSAVE, 2-39
 ACQUIRE:MODE, 2-40
 ACQUIRE:NUMACQ?, 2-42
 ACQUIRE:NUMAVG, 2-43
 ACQUIRE:NUMENV, 2-43
 ACQUIRE:REPET, 2-44
 ACQUIRE:STATE, 2-45
 ACQUIRE:STOPAFTER, 2-46
Address, Definition of, *Glossary-1*
ALIAS, 2-47
Alias commands
 ALIAS, 2-47
 ALIAS:CATALOG?, 2-48
 ALIAS:DEFINE, 2-48
 ALIAS:DELETE, 2-50
 ALIAS:DELETE:ALL, 2-50
 ALIAS:DELETE:NAME, 2-50
 ALIAS:STATE, 2-51
ALIAS:CATALOG?, 2-48
ALIAS:DEFINE, 2-48
ALIAS:DELETE, 2-50
ALIAS:DELETE:ALL, 2-50
ALIAS:DELETE:NAME, 2-50
ALIAS:STATE, 2-51
ALLEV?, 2-51
ALLOCATE?, 2-52
ALLOCATE:WAVEFORM?, 2-53
ALLOCATE:WAVEFORM:FREE?, 2-53
ALLOCATE:WAVEFORM:REF<x>, 2-54
Application menu command group, 2-12
Application menu commands
 APPMENU, 2-55
 APPMENU:LABEL, 2-56
 APPMENU:LABEL:BOTTOM, 2-56
 APPMENU:LABEL:RIGHT, 2-57

 APPMENU:LABEL:TITLE, 2-58
APPMENU, 2-55
APPMENU:LABEL, 2-56
APPMENU:LABEL:BOTTOM, 2-56
APPMENU:LABEL:RIGHT, 2-57
APPMENU:LABEL:TITLE, 2-58
Argument, command, 2-2
ASCII, 2-1, *Glossary-1*
Audio indicator, 2-59
AUTOSAVE, 2-39

B

Backus-Naur Form, 2-1
 Definition of, *Glossary-1*
BELL, 2-59
Block, command argument, 2-9
BNF, *Glossary-1*
BNF (Backus-Naur form), 2-1
Break, 2-3
BUSY?, 2-60

C

*CAL?, 2-60
Calibration and diagnostic command group, 2-13
Calibration and diagnostic commands
 *CAL?, 2-60
 DIAG:RESULT:FLAG?, 2-97
 DIAG:RESULT:LOG?, 2-98
 DIAG:SELECT:ACQUISITION, 2-99
 DIAG:SELECT:ALL, 2-99
 DIAG:SELECT:CPU, 2-99
 DIAG:SELECT:DISPLAY, 2-100
 DIAG:SELECT:FPANEL, 2-100
 DIAG:STATE, 2-101
CH<x>?, 2-61
CH<x>:BANDWIDTH, 2-61
CH<x>:COUPLING, 2-62
CH<x>:IMPEDANCE, 2-63
CH<x>:OFFSET, 2-64
CH<x>:POSITION, 2-65
CH<x>:PROBE?, 2-66
CH<x>:SCALE, 2-66
CH<x>:VOLTS, 2-67
Channel, command mnemonic, 2-7
CH<x>, command mnemonic, 2-7
Clear Status, 2-68
CLEARMENU, 2-68

- *CLS, 2-68
- Command
 - Abbreviating, 2-4
 - Argument, 2-2
 - Block argument, 2-9
 - Common, 2-21, 2-23
 - Concatenating, 2-4
 - Header, 2-2
 - Message, 2-2
 - Mnemonic, 2-2
 - Query, 2-1
 - Rules for forming, 2-1
 - Separator, 2-2
 - Set, 2-1
 - Syntax, 2-1
 - BNF (Backus-Naur form), 2-1
- Command argument
 - Numeric, 2-7
 - Quoted string, 2-8
- Command Descriptions, 1-1
- Command group
 - Acquisition, 2-11, 2-12
 - Application menu, 2-12
 - Calibration and diagnostic, 2-13
 - Cursor, 2-13
 - Display, 2-14
 - File system, 2-16
 - Hardcopy, 2-17
 - Horizontal, 2-17
 - Limit test, 2-19
 - Measurement, 2-19
 - Miscellaneous, 2-21
 - RS-232, 2-22
 - Save and recall, 2-22
 - Status and error, 2-23
 - Trigger, 2-24
 - Vertical, 2-31
 - Waveform, 2-32
 - Zoom, 2-37
- Command Groups, 1-1
- Command mnemonic
 - Channel, 2-7
 - CH<x>, 2-7
 - Cursor position, 2-6
 - Math waveform, 2-7
 - MATH<x>, 2-7
 - Measurement specifier, 2-6
 - MEAS<x>, 2-6
 - POSITION<x>, 2-6
 - Reference waveform, 2-7
 - REF<x>, 2-7
 - Waveform, 2-7
 - <wfm>, 2-7
- Command syntax, 2-1
 - BNF (Backus-Naur form), 2-1
- Commands, 1-1
 - Parts of, 1-1
 - Syntax diagrams, 1-1
- Common command, 2-21, 2-23
- Common GPIB commands
 - *CAL?, 2-60
 - *CLS, 2-68
- Concatenating, command, 2-4
- Configuration, Command query, 2-156
- Controller, Definition of, *Glossary-1*
- Cursor command group, 2-13
- Cursor commands
 - CURSOR?, 2-69
 - CURSOR:FUNCTION, 2-69
 - CURSOR:HBARS?, 2-70
 - CURSOR:HBARS:DELTA?, 2-70
 - CURSOR:HBARS:POSITION<x>, 2-71
 - CURSOR:HBARS:POSITION<x>PCNT, 2-71
 - CURSOR:HBARS:SELECT, 2-72
 - CURSOR:HBARS:UNITS, 2-73
 - CURSOR:MODE, 2-73
 - CURSOR:PAIRED, 2-74
 - CURSOR:PAIRED:HDELTA, 2-75
 - CURSOR:PAIRED:HPOS1, 2-75
 - CURSOR:PAIRED:HPOS2, 2-76
 - CURSOR:PAIRED:POSITION<x>, 2-76
 - CURSOR:PAIRED:POSITION<x>PCNT, 2-77
 - CURSOR:PAIRED:SELECT, 2-77
 - CURSOR:PAIRED:UNITS, 2-78
 - CURSOR:PAIRED:VDELTA, 2-79
 - CURSOR:VBARS, 2-79
 - CURSOR:VBARS:DELTA?, 2-80
 - CURSOR:VBARS:POSITION<x>, 2-81
 - CURSOR:VBARS:POSITION<x>PCNT, 2-81
 - CURSOR:VBARS:SELECT, 2-82
 - CURSOR:VBARS:UNITS, 2-83
 - CURSOR:VBARS:UNITSTring, 2-85
- Cursor position, command mnemonic, 2-6
- CURSOR?, 2-69
- CURSOR:FUNCTION, 2-69
- CURSOR:HBARS?, 2-70
- CURSOR:HBARS:DELTA?, 2-70
- CURSOR:HBARS:POSITION<x>, 2-71
- CURSOR:HBARS:POSITION<x>PCNT, 2-71
- CURSOR:HBARS:SELECT, 2-72
- CURSOR:HBARS:UNITS, 2-73
- CURSOR:MODE, 2-73
- CURSOR:PAIRED, 2-74
- CURSOR:PAIRED:HDELTA, 2-75
- CURSOR:PAIRED:HPOS1, 2-75
- CURSOR:PAIRED:HPOS2, 2-76

CURSOR:PAIRED:POSITION<x>, 2-76
 CURSOR:PAIRED:POSITION<x>PCNT, 2-77
 CURSOR:PAIRED:SELECT, 2-77
 CURSOR:PAIRED:UNITS, 2-78
 CURSOR:PAIRED:VDelta, 2-79
 CURSOR:VBARS, 2-79
 CURSOR:VBARS:DELTA?, 2-80
 CURSOR:VBARS:POSITION<x>, 2-81
 CURSOR:VBARS:POSITION<x>PCNT, 2-81
 CURSOR:VBARS:SELECT, 2-82
 CURSOR:VBARS:UNITS, 2-83
 CURSOR:VBARS:UNITString, 2-85
 CURVE, 2-85

D

DATA, 2-87
 DATA:DESTINATION, 2-87
 DATA:ENCDG, 2-88
 DATA:SOURCE, 2-90
 DATA:START, 2-91
 DATA:STOP, 2-92
 DATA:TARGET, 2-92
 DATA:WIDTH, 2-93
 DATE, 2-94
 DCL, C-2
 *DDT, 2-94
 Delayed trigger, 2-220, 2-221, 2-222, 2-223, 2-224,
 2-225, 2-226, 2-227
 DELETE:SETUP, 2-95
 DELETE:WAVEFORM, 2-96
 DESE command, 2-96, 3-3
 DESER register, 2-96, 2-202, 3-3
 Device Clear, 2-3, C-2
 DIAG:RESULT:FLAG?, 2-97
 DIAG:RESULT:LOG?, 2-98
 DIAG:SELECT:ACQUISITION, 2-99
 DIAG:SELECT:ALL, 2-99
 DIAG:SELECT:CPU, 2-99
 DIAG:SELECT:DISPLAY, 2-100
 DIAG:SELECT:FPANEL, 2-100
 DIAG:STATE, 2-101
 Diagram, syntax, 2-10
 Disks included with this manual, 1-2
 Display command group, 2-14
 Display commands
 CLEARMENU, 2-68
 DISPLAY?, 2-102
 DISPLAY:CLOCK, 2-102
 DISPLAY:COLOR:CONTRAST, 2-103
 DISPLAY:COLOR:MAP:item name:TO, 2-105
 DISPLAY:COLOR:MAP:item:BYCONTENTS, 2-104
 DISPLAY:COLOR:PALETTE:palette name:item name,
 2-108
 DISPLAY:COLOR:PALETTE:palette name:RESET,
 2-107
 DISPLAY:COLOR:PALETTE:PERSISTENCE, 2-106
 DISPLAY:COLOR:PALETTE:REGULAR, 2-106
 DISPLAY:COLOR:PALETTE:RESETALL, 2-107
 DISPLAY:DATE/TIME. *See DISPLAY:CLOCK*
 DISPLAY:FILTER, 2-110
 DISPLAY:FORMAT, 2-111
 DISPLAY:GRATICULE, 2-112
 DISPLAY:INSTAVU:PERSISTENCE, 2-113
 DISPLAY:INSTAVU:STYLE, 2-114
 DISPLAY:INSTAVU:VARPERSIST, 2-114
 DISPLAY:INTENSITY?, 2-115
 DISPLAY:INTENSITY:CONTRAST, 2-115
 DISPLAY:INTENSITY:OVERALL, 2-116
 DISPLAY:INTENSITY:TEXT, 2-117
 DISPLAY:INTENSITY:WAVEFORM, 2-117
 DISPLAY:MODE, 2-118
 DISPLAY:PERSISTENCE, 2-118
 DISPLAY:STYLE, 2-119
 DISPLAY:TRIGBAR, 2-120
 DISPLAY:TRIGT, 2-121
 MESSAGE, 2-196
 MESSAGE:BOX, 2-196
 MESSAGE:SHOW, 2-198
 MESSAGE:STATE, 2-199
 DISPLAY?, 2-102
 DISPLAY:CLOCK, 2-102
 DISPLAY:COLOR:CONTRAST, 2-103
 DISPLAY:COLOR:MAP:item name:TO, 2-105
 DISPLAY:COLOR:MAP:item:BYCONTENTS, 2-104
 DISPLAY:COLOR:PALETTE:palette name:item name,
 2-108
 DISPLAY:COLOR:PALETTE:palette name:RESET,
 2-107
 DISPLAY:COLOR:PALETTE:PERSISTENCE, 2-106
 DISPLAY:COLOR:PALETTE:REGULAR, 2-106
 DISPLAY:COLOR:PALETTE:RESETALL, 2-107
 DISPLAY:DATE/TIME. *See DISPLAY:CLOCK*
 DISPLAY:FILTER, 2-110
 DISPLAY:FORMAT, 2-111
 DISPLAY:GRATICULE, 2-112
 DISPLAY:INSTAVU:PERSISTENCE, 2-113
 DISPLAY:INSTAVU:STYLE, 2-114
 DISPLAY:INSTAVU:VARPERSIST, 2-114
 DISPLAY:INTENSITY?, 2-115

DISPLAY:COLOR:MAP:item:BYCONTENTS,
 2-104
 DISPLAY:COLOR:PALETTE:palette name:item
 name, 2-108
 DISPLAY:COLOR:PALETTE:palette name:RESET,
 2-107
 DISPLAY:COLOR:PALETTE:PERSISTENCE,
 2-106
 DISPLAY:COLOR:PALETTE:REGULAR, 2-106
 DISPLAY:COLOR:PALETTE:RESETALL, 2-107
 DISPLAY:DATE/TIME. *See DISPLAY:CLOCK*
 DISPLAY:FILTER, 2-110
 DISPLAY:FORMAT, 2-111
 DISPLAY:GRATICULE, 2-112
 DISPLAY:INSTAVU:PERSISTENCE, 2-113
 DISPLAY:INSTAVU:STYLE, 2-114
 DISPLAY:INSTAVU:VARPERSIST, 2-114
 DISPLAY:INTENSITY?, 2-115
 DISPLAY:INTENSITY:CONTRAST, 2-115
 DISPLAY:INTENSITY:OVERALL, 2-116
 DISPLAY:INTENSITY:TEXT, 2-117
 DISPLAY:INTENSITY:WAVEFORM, 2-117
 DISPLAY:MODE, 2-118
 DISPLAY:PERSISTENCE, 2-118
 DISPLAY:STYLE, 2-119
 DISPLAY:TRIGBAR, 2-120
 DISPLAY:TRIGT, 2-121
 MESSAGE, 2-196
 MESSAGE:BOX, 2-196
 MESSAGE:SHOW, 2-198
 MESSAGE:STATE, 2-199
 DISPLAY?, 2-102
 DISPLAY:CLOCK, 2-102
 DISPLAY:COLOR:CONTRAST, 2-103
 DISPLAY:COLOR:MAP:item name:TO, 2-105
 DISPLAY:COLOR:MAP:item:BYCONTENTS, 2-104
 DISPLAY:COLOR:PALETTE:palette name:item name,
 2-108
 DISPLAY:COLOR:PALETTE:palette name:RESET,
 2-107
 DISPLAY:COLOR:PALETTE:PERSISTENCE, 2-106
 DISPLAY:COLOR:PALETTE:REGULAR, 2-106
 DISPLAY:COLOR:PALETTE:RESETALL, 2-107
 DISPLAY:DATE/TIME. *See DISPLAY:CLOCK*
 DISPLAY:FILTER, 2-110
 DISPLAY:FORMAT, 2-111
 DISPLAY:GRATICULE, 2-112
 DISPLAY:INSTAVU:PERSISTENCE, 2-113
 DISPLAY:INSTAVU:STYLE, 2-114
 DISPLAY:INSTAVU:VARPERSIST, 2-114
 DISPLAY:INTENSITY?, 2-115

DISPLAY:INTENSITY:CONTRAST, 2-115
DISPLAY:INTENSITY:OVERALL, 2-116
DISPLAY:INTENSITY:TEXT, 2-117
DISPLAY:INTENSITY:WAVEFORM, 2-117
DISPLAY:MODE, 2-118
DISPLAY:PERSISTENCE, 2-118
DISPLAY:STYLE, 2-119
DISPLAY:TRIGBAR, 2-120
DISPLAY:TRIGT, 2-121

E

Edge trigger, 2-228, 2-229, 2-230, 2-265
End or Identify, *Glossary-1*
EOI, *Glossary-1*
EOM, *Glossary-1*
EOM (end of message), 2-5
Equivalent-time sampling, random, *Glossary-1*
Error message, programming interface, 3-12
Error messages, 1-2
*ESE, 2-121, 3-3
ESER register, 2-121, 2-202, 3-3
*ESR?, 2-122
*ESR? query, 3-1
Event handling, 3-1, 3-6
Event query, 2-123
Event queue, 2-123, 3-5
EVENT?, 2-123
EVMSG?, 2-123
EVQTY?, 2-124
Example programs, 1-2
 On disk, 1-2

F

FACTORY, 2-125
Factory initialization settings, *D-1-D-6*
FASTFRAME, 2-147, 2-148
File system command group, 2-16
File system commands
 FILESYSTEM:COPY, 2-126
 FILESYSTEM:CWD, 2-127
 FILESYSTEM:DELETE, 2-127
 FILESYSTEM:DELWARN, 2-128
 FILESYSTEM:DIR, 2-129
 FILESYSTEM:FORMAT, 2-129
 FILESYSTEM:FREESPACE, 2-129
 FILESYSTEM:MKDIR, 2-130
 FILESYSTEM:OVERWRITE, 2-130
 FILESYSTEM:PRINT, 2-131
 FILESYSTEM:RENAME, 2-132
 FILESYSTEM:RMDIR, 2-132

FILESYSTEM:COPY, 2-126
FILESYSTEM:CWD, 2-127
FILESYSTEM:DELETE, 2-127
FILESYSTEM:DELWARN, 2-128
FILESYSTEM:DIR, 2-129
FILESYSTEM:FORMAT, 2-129
FILESYSTEM:FREESPACE, 2-129
FILESYSTEM:MKDIR, 2-130
FILESYSTEM:OVERWRITE, 2-130
FILESYSTEM:PRINT, 2-131
FILESYSTEM:RENAME, 2-132
FILESYSTEM:RMDIR, 2-132
FITTOSCREEN, 2-149

G

GET, C-2
Glitch trigger, 2-249, 2-250, 2-251, 2-252
Go to local, C-2
GPIB, *Glossary-1*
 Configurations, 1-4
 Connection rules, 1-4
 EOM (end of message), 2-5
 Function subsets, C-1
Group execute trigger, C-2
GTL, C-2

H

HARDCOPY, 2-133
Hardcopy command group, 2-17
Hardcopy commands
 HARDCOPY, 2-133
 HARDCOPY:FILENAME, 2-134
 HARDCOPY:FORMAT, 2-135
 HARDCOPY:LAYOUT, 2-137
 HARDCOPY:PALETTE, 2-137
 HARDCOPY:PORT, 2-138
HARDCOPY:FILENAME, 2-134
HARDCOPY:FORMAT, 2-135
HARDCOPY:LAYOUT, 2-137
HARDCOPY:PALETTE, 2-137
HARDCOPY:PORT, 2-138
HDR, 2-139
HEADER, 2-139
Header
 Command, 2-2, 2-139
 Included in query response, 2-139, 2-287
Horizontal command group, 2-17
Horizontal commands
 HORIZONTAL?, 2-140
 HORIZONTAL:CLOCK, 2-141

HORIZONTAL:CLOCK:MAXRATE, 2-141
 HORIZONTAL:DELAY?, 2-142
 HORIZONTAL:DELAY:MODE, 2-142
 HORIZONTAL:DELAY:SCALE, 2-143
 HORIZONTAL:DELAY:SECDIV, 2-144
 HORIZONTAL:DELAY:TIME, 2-144
 HORIZONTAL:DELAY:TIME?, 2-145
 HORIZONTAL:DELAY:TIME:RUNSAFTER,
 2-145
 HORIZONTAL:DELAY:TIME:TRIGAFTER, 2-146
 HORIZONTAL:FASTFRAME:COUNT, 2-147
 HORIZONTAL:FASTFRAME:LENGTH, 2-147
 HORIZONTAL:FASTFRAME:POSITION, 2-148
 HORIZONTAL:FASTFRAME:STATE, 2-148
 HORIZONTAL:FITTOSCREEN, 2-149
 HORIZONTAL:MAIN?, 2-150
 HORIZONTAL:MAIN:SCALE, 2-150
 HORIZONTAL:MAIN:SECDIV, 2-151
 HORIZONTAL:MODE, 2-152
 HORIZONTAL:POSITION, 2-153
 HORIZONTAL:RECORDLENGTH, 2-153
 HORIZONTAL:SCALE, 2-154
 HORIZONTAL:SECDIV, 2-155
 HORIZONTAL:TRIGGER?, 2-155
 HORIZONTAL:TRIGGER:POSITION, 2-155
 HORIZONTAL?, 2-140
 HORIZONTAL:CLOCK, 2-141
 HORIZONTAL:CLOCK:MAXRATE, 2-141
 HORIZONTAL:DELAY?, 2-142
 HORIZONTAL:DELAY:MODE, 2-142
 HORIZONTAL:DELAY:SCALE, 2-143
 HORIZONTAL:DELAY:SECDIV, 2-144
 HORIZONTAL:DELAY:TIME, 2-144
 HORIZONTAL:DELAY:TIME?, 2-145
 HORIZONTAL:DELAY:TIME:RUNSAFTER, 2-145
 HORIZONTAL:DELAY:TIME:TRIGAFTER, 2-146
 HORIZONTAL:FASTFRAME:COUNT, 2-147
 HORIZONTAL:FASTFRAME:LENGTH, 2-147
 HORIZONTAL:FASTFRAME:POSITION, 2-148
 HORIZONTAL:FASTFRAME:STATE, 2-148
 HORIZONTAL:FITTOSCREEN, 2-149
 HORIZONTAL:MAIN?, 2-150
 HORIZONTAL:MAIN:SCALE, 2-150
 HORIZONTAL:MAIN:SECDIV, 2-151
 HORIZONTAL:MODE, 2-152
 HORIZONTAL:POSITION, 2-153
 HORIZONTAL:RECORDLENGTH, 2-153
 HORIZONTAL:SCALE, 2-154
 HORIZONTAL:SECDIV, 2-155
 HORIZONTAL:TRIGGER?, 2-155
 HORIZONTAL:TRIGGER:POSITION, 2-155

I

ID?, 2-156
 *IDN?, 2-156
 IEEE, *Glossary*-2
 IEEE Std 488.2-1987, 1-3, 2-1, 2-21, 2-23
 Instrument setup, 1-3
 Interface message, C-2

L

Limit test command group, 2-19
 Limit Test commands
 LIMIT:BELL, 2-157
 LIMIT:COMPARE:CH<x>, 2-158
 LIMIT:COMPARE:MATH<x>, 2-159
 LIMIT:HARDCOPY, 2-159
 LIMIT:STATE, 2-160
 LIMIT:TEMPLATE, 2-161
 LIMIT:TEMPLATE:DESTINATION, 2-162
 LIMIT:TEMPLATE:SOURCE, 2-162
 LIMIT:TEMPLATE:TOLERANCE: VERTICAL,
 2-164
 LIMIT:TEMPLATE:TOLERANCE:HORIZONTAL,
 2-163
 LIMIT:BELL, 2-157
 LIMIT:COMPARE:CH<X>, 2-158
 LIMIT:COMPARE:MATH<X>, 2-159
 LIMIT:HARDCOPY, 2-159
 LIMIT:STATE, 2-160
 LIMIT:TEMPLATE, 2-161
 LIMIT:TEMPLATE:DESTINATION, 2-162
 LIMIT:TEMPLATE:SOURCE, 2-162
 LIMIT:TEMPLATE:TOLERANCE: VERTICAL,
 2-164
 LIMIT:TEMPLATE:TOLERANCE:HORIZONTAL,
 2-163
 LLO, C-2
 Local lock out, C-2
 LOCK, 2-165
 Logic trigger, 2-234, 2-235, 2-236, 2-237, 2-238,
 2-239, 2-240, 2-241, 2-242, 2-243, 2-244,
 2-245, 2-246, 2-247, 2-265
 *LRN?, 2-165

M

Manual trigger, Simulation with command, 2-285
 Math waveform, command mnemonic, 2-7
 MATH<x>?, 2-166

- MATH<x>:DEFINE, 2-166
MATH<x>:NUMAVg, 2-168
MATH<x>:PROCCessing, 2-169
MATH<x>, command mnemonic, 2-7
Measurement command group, 2-19
Measurement commands
 MEASUREMENT?, 2-170
 MEASUREMENT:CLEARSNAPSHOT, 2-170
 MEASUREMENT:GATING, 2-171
 MEASUREMENT:IMMED?, 2-171
 MEASUREMENT:IMMED:DELAY?, 2-172
 MEASUREMENT:IMMED:DELAY:DIRECTION,
 2-172
 MEASUREMENT:IMMED:DELAY:EDGE1, 2-173
 MEASUREMENT:IMMED:DELAY:EDGE2, 2-174
 MEASUREMENT:IMMED:SOURCE1, 2-175
 MEASUREMENT:IMMED:SOURCE2, 2-176
 MEASUREMENT:IMMED:TYPE, 2-176
 MEASUREMENT:IMMED:UNITS?, 2-179
 MEASUREMENT:IMMED:VALUE?, 2-179
 MEASUREMENT:MEAS<x>?, 2-180
 MEASUREMENT:MEAS<x>: DELAY?, 2-180
 MEASUREMENT:MEAS<x>: DELAY:
 DIRECTION?, 2-180
 MEASUREMENT:MEAS<x>: DELAY:EDGE1,
 2-181
 MEASUREMENT:MEAS<x>: DELAY:EDGE2,
 2-182
 MEASUREMENT:MEAS<x>: DELAY:SOURCE1,
 2-183
 MEASUREMENT:MEAS<x>: DELAY:SOURCE2,
 2-184
 MEASUREMENT:MEAS<x>: STATE, 2-184
 MEASUREMENT:MEAS<x>: TYPE, 2-185
 MEASUREMENT:MEAS<x>: UNITS?, 2-188
 MEASUREMENT:MEAS<x>: VALUES?, 2-188
 MEASUREMENT:METHOD, 2-189
 MEASUREMENT:REFLEVEL?, 2-189
 MEASUREMENT:REFLEVEL:
 ABSOLUTE:HIGH, 2-190
 MEASUREMENT:REFLEVEL: ABSOLUTE:MID,
 2-191
 MEASUREMENT:REFLEVEL:
 ABSOLUTE:MID2, 2-192
 MEASUREMENT:REFLEVEL: METHOD, 2-192
 MEASUREMENT:REFLEVEL: PERCENT:HIGH,
 2-193
 MEASUREMENT:REFLEVEL: PERCENT:LOW,
 2-194
 MEASUREMENT:REFLEVEL: PERCENT:MID,
 2-194
 MEASUREMENT:REFLEVEL: PERCENT:MID2,
 2-195
 MEASUREMENT:REFLEVEL:ABSOLUTE:LOW,
 2-190
 MEASUREMENT:SNAPSHOT, 2-196
 Measurement specifier, command mnemonic, 2-6
 MEASUREMENT?, 2-170
 MEASUREMENT:CLEARSNAPSHOT, 2-170
 MEASUREMENT:GATING, 2-171
 MEASUREMENT:IMMED?, 2-171
 MEASUREMENT:IMMED:DELAY?, 2-172
 MEASUREMENT:IMMED:DELAY:DIRECTION,
 2-172
 MEASUREMENT:IMMED:DELAY:EDGE1, 2-173
 MEASUREMENT:IMMED:DELAY:EDGE2, 2-174
 MEASUREMENT:IMMED:SOURCE1, 2-175
 MEASUREMENT:IMMED:SOURCE2, 2-176
 MEASUREMENT:IMMED:TYPE, 2-176
 MEASUREMENT:IMMED:UNITS?, 2-179
 MEASUREMENT:IMMED:VALUE?, 2-179
 MEASUREMENT:MEAS<x>?, 2-180
 MEASUREMENT:MEAS<x>: DELAY?, 2-180
 MEASUREMENT:MEAS<x>: DELAY:DIRECTION?,
 2-180
 MEASUREMENT:MEAS<x>: DELAY:EDGE1, 2-181
 MEASUREMENT:MEAS<x>: DELAY:EDGE2, 2-182
 MEASUREMENT:MEAS<x>: DELAY:SOURCE1,
 2-183
 MEASUREMENT:MEAS<x>: DELAY:SOURCE2,
 2-184
 MEASUREMENT:MEAS<x>: STATE, 2-184
 MEASUREMENT:MEAS<x>: TYPE, 2-185
 MEASUREMENT:MEAS<x>: UNITS?, 2-188
 MEASUREMENT:MEAS<x>: VALUES?, 2-188
 MEASUREMENT:METHOD, 2-189
 MEASUREMENT:REFLEVEL?, 2-189
 MEASUREMENT:REFLEVEL:ABSOLUTE:HIGH,
 2-190
 MEASUREMENT:REFLEVEL:ABSOLUTE:LOW,
 2-190
 MEASUREMENT:REFLEVEL:ABSOLUTE:MID,
 2-191
 MEASUREMENT:REFLEVEL:ABSOLUTE:MID2,
 2-192
 MEASUREMENT:REFLEVEL:METHOD, 2-192
 MEASUREMENT:REFLEVEL:PERCENT:HIGH,
 2-193
 MEASUREMENT:REFLEVEL:PERCENT:LOW,
 2-194
 MEASUREMENT:REFLEVEL:PERCENT:MID,
 2-194

MEASUREMENT:REFLEVEL:PERCENT:MID2,
2-195

MEASUREMENT:SNAPSHOT, 2-196

MEAS<x>, command mnemonic, 2-6

MESSAGE, 2-196

Message

Command, 2-2

Command terminator, 2-5

Handling, 3-1

Table of program messages, 3-12

MESSAGE:BOX, 2-196

MESSAGE:SHOW, 2-198

MESSAGE:STATE, 2-199

Messages, Status and error, 1-2

Miscellaneous, LOCK, 2-165

Miscellaneous command group, 2-21

Miscellaneous commands

AUTOSET, 2-59

BELL, 2-59

DATE, 2-94

*DDT, 2-94

FACTORY, 2-125

HDR, 2-139

HEADER, 2-139

*IDN?, 2-156

*LRN?, 2-165

NEWPASS, 2-199

PASSWORD, 2-201

*PUD, 2-203

REM, 2-206

SET, 2-216

TEKSECURE, 2-218

TIME, 2-218

*TRG, 2-285

UNLOCK, 2-286

VERBOSE, 2-287

Mnemonic, command, 2-2

N

NEWPASS, 2-199

Numeric, command argument, 2-7

O

*OPC, 2-200

Operation complete command, 2-200

Operation complete wait, 2-287

*OPT, 2-201

Option Identification Query, 2-201

Output queue, 3-5

P

Parallel poll, C-2

Parts of commands, 1-1

PASSWORD, 2-201

Pattern trigger, 2-237, 2-238, 2-239, 2-240

POSITION<x>, command mnemonic, 2-6

Power-on status clear command, 2-202

PPC, C-2

PPD, C-2

PPE, C-2

PPU, C-2

Programming Examples, 1-2, 4-1

*PSC, 2-202

*PSC command, 3-4

*PUD, 2-203

Pulse trigger, 2-248, 2-249, 2-250, 2-251, 2-252,
2-253, 2-254, 2-255, 2-256, 2-257, 2-258,
2-259, 2-260, 2-261, 2-262, 2-263, 2-264, 2-265

Q

Query, Header in query response, 2-139, 2-287

Query command, 2-1

Queue

Event, 3-5

Output, 3-5

QuickBASIC, 4-1, *Glossary-2*

QuickC, 4-1, *Glossary-2*

Quoted string, command argument, 2-8

R

*RCL, 2-204

Real-time sampling, *Glossary-1*

Recall setting command, 2-204

RECALL:SETUP, 2-204

RECALL:WAVEFORM, 2-205

Reference waveform, command mnemonic, 2-7

REF<x>, command mnemonic, 2-7

Register

DESER, 2-96, 2-202, 3-3

ESER, 2-121, 2-202, 3-3

SBR, 2-217, 3-2

SESR, 2-68, 2-122, 2-200, 3-1

SRER, 2-202, 2-217, 3-4

REM, 2-206

Reset

Command, 2-206

Factory, 2-125

RS-232 command group, 2-22

- RS-232 commands
 - RS232?, 2-210
 - RS232:BAUD, 2-207
 - RS232:HARDFLAGGING, 2-208
 - RS232:PARITY, 2-208
 - RS232:SOFTFLAGGING, 2-209
 - RS232:STOPBITS, 2-210
 - RS232?, 2-210
 - RS232: BAUD, 2-207
 - RS232:HARDFLAGGING, 2-208
 - RS232:PARITY, 2-208
 - RS232:SOFTFLAGGING, 2-209
 - RS232:STOPBITS, 2-210
 - *RST, 2-206
 - Rules, command forming, 2-1
 - Runt trigger, 2-249, 2-252, 2-253, 2-254, 2-255, 2-256
- S**
- *SAV, 2-211
 - Save and recall command group, 2-22
 - Save and recall commands
 - ALLOCATE?, 2-52
 - ALLOCATE:WAVEFORM?, 2-53
 - ALLOCATE:WAVEFORM:FREE?, 2-53
 - ALLOCATE:WAVEFORM:REF<x>, 2-54
 - DELETE.SETUP, 2-95
 - DELETE:WAVEFORM, 2-96
 - *RCL, 2-204
 - RECALL:SETUP, 2-204
 - RECALL:WAVEFORM, 2-205
 - *SAV, 2-211
 - SAVE:SETUP, 2-211
 - SAVE:WAVEFORM, 2-212
 - SAVE:WAVEFORM:FILEFORMT, 2-213
 - Save setting command, 2-211
 - SAVE:SETUP, 2-211
 - SAVE:WAVEFORM, 2-212
 - SAVE:WAVEFORM:FILEFORMT, 2-213
 - SBR register, 2-217, 3-2
 - SDC, C-2
 - SELECT?, 2-214
 - SELECT:<wfm>, 2-215
 - SELECT:CONTROL?, 2-215
 - Selected device clear, C-2
 - Self test, 2-286
 - Separator, command, 2-2
 - Serial poll, 3-2
 - Disable, C-2
 - Enable, C-2
 - Service request enable command, 2-217
 - Service request enable register, 2-217
 - Service Requests, 1-2
 - SESR register, 2-68, 2-122, 2-200, 3-1
 - Set command, 2-1
 - SET?, 2-216
 - Sethold trigger, 2-240, 2-241, 2-242, 2-243, 2-244
 - Setting
 - Command query, 2-165
 - Query, 2-165
 - Recall command, 2-204
 - Save command, 2-211
 - Setup, Instrument preparation, 1-3
 - Slewrates trigger, 2-249, 2-257, 2-258, 2-259, 2-260, 2-261
 - SPD, C-2
 - SPE, C-2
 - *SRE command, 2-217, 3-4
 - SRER register, 2-202, 2-217, 3-4
 - SRQ, 1-2
 - State trigger, 2-245, 2-246
 - Status, 3-1
 - Status and error command group, 2-23
 - Status and error commands
 - *OPT, 2-201
 - ALLEV?, 2-51
 - BUSY?, 2-60
 - *CLS, 2-68
 - DESE, 2-96, 3-3
 - *ESE, 2-121, 3-3
 - *ESR?, 2-122, 3-1
 - EVENT?, 2-123
 - EVMSG?, 2-123
 - EVQTY?, 2-124
 - ID?, 2-156
 - *OPC, 2-200
 - *PSC, 2-202, 3-4
 - *RST, 2-206
 - *SRE, 2-217, 3-4
 - *STB?, 2-217, 3-2
 - *TST?, 2-286
 - *WAI, 2-287
 - Status and Events, 1-2
 - *STB?, 2-217
 - *STB? query, 3-2
 - Syntax
 - BNF (Backus-Naur form), 2-1
 - Command, 2-1
 - Diagram, 2-10
 - Syntax and Commands, 1-1
 - Syntax diagrams, 1-1

T

Table, programming message, 3–12

TCT, C–2

Tek Standard Codes and Formats 1989, 2–23

TEKSECURE, 2–218

TEKSecure, *Glossary*–2

Terminator, command message, 2–5

TIME, 2–218

Time base, Manual trigger simulation, 2–285

*TRG, 2–285

TRIGGER, 2–219

Trigger command group, 2–24

Trigger commands

TRIGGER, 2–219

TRIGGER:DELAY, 2–220

TRIGGER:DELAY:BY, 2–221

TRIGGER:DELAY:EDGE?, 2–222

TRIGGER:DELAY:EDGE:COUPLING, 2–222

TRIGGER:DELAY:EDGE:SLOPE, 2–223

TRIGGER:DELAY:EDGE:SOURCE, 2–224

TRIGGER:DELAY:EVENTS?, 2–224

TRIGGER:DELAY:EVENTS:COUNT, 2–225

TRIGGER:DELAY:LEVEL, 2–225

TRIGGER:DELAY:TIME, 2–226

TRIGGER:DELAY:TYPE, 2–227

TRIGGER:MAIN, 2–227

TRIGGER:MAIN:EDGE?, 2–228

TRIGGER:MAIN:EDGE:COUPLING, 2–228

TRIGGER:MAIN:EDGE:SLOPE, 2–229

TRIGGER:MAIN:EDGE:SOURCE, 2–230

TRIGGER:MAIN:HOLDOFF?, 2–230

TRIGGER:MAIN:HOLDOFF:ACTUAL?, 2–231

TRIGGER:MAIN:HOLDOFF:BY, 2–231

TRIGGER:MAIN:HOLDOFF:TIME, 2–232

TRIGGER:MAIN:HOLDOFF:VALUE, 2–233

TRIGGER:MAIN:LEVEL, 2–233

TRIGGER:MAIN:LOGIC?, 2–234

TRIGGER:MAIN:LOGIC:CLASS, 2–234

TRIGGER:MAIN:LOGIC:CLOCK:LEVEL, 2–241

TRIGGER:MAIN:LOGIC:DATA:LEVEL, 2–242

TRIGGER:MAIN:LOGIC:FUNCTION, 2–235

TRIGGER:MAIN:LOGIC:INPUT?, 2–236

TRIGGER:MAIN:LOGIC:INPUT: CH<x>?, 2–237

TRIGGER:MAIN:LOGIC:PATTERN: INPUT:CH4?,
2–237

TRIGGER:MAIN:LOGIC:PATTERN: WHEN,
2–238

TRIGGER:MAIN:LOGIC:PATTERN:
WHEN:LESSLIMIT, 2–239

TRIGGER:MAIN:LOGIC:PATTERN: WHEN:
MORELIMIT, 2–240

TRIGGER:MAIN:LOGIC:

SETHOLD:CLOCK:EDGE, 2–240

TRIGGER:MAIN:LOGIC:

SETHOLD:CLOCK:SOURCE, 2–242

TRIGGER:MAIN:LOGIC:

SETHOLD:DATA:SOURCE, 2–243

TRIGGER:MAIN:LOGIC:SETHOLD:HOLDTIME,
2–244

TRIGGER:MAIN:LOGIC:SETHOLD:SETTIME,
2–244

TRIGGER:MAIN:LOGIC:STATE: INPUT:CH4?,
2–245

TRIGGER:MAIN:LOGIC:STATE:WHEN, 2–246

TRIGGER:MAIN:LOGIC:THRESHOLD?, 2–246

TRIGGER:MAIN:LOGIC:THRESHOLD:CH<x>,
2–247

TRIGGER:MAIN:LOGIC:WHEN, 2–247

TRIGGER:MAIN:MODE, 2–248

TRIGGER:MAIN:PULSE?, 2–248

TRIGGER:MAIN:PULSE:CLASS, 2–249

TRIGGER:MAIN:PULSE:GLITCH?, 2–250

TRIGGER:MAIN:PULSE:GLITCH:FILTER, 2–250

TRIGGER:MAIN:PULSE:GLITCH:POLARITY,
2–251

TRIGGER:MAIN:PULSE:GLITCH:WIDTH, 2–252

TRIGGER:MAIN:PULSE:RUNT?, 2–252

TRIGGER:MAIN:PULSE:RUNT:POLARITY,
2–253

TRIGGER:MAIN:PULSE:RUNT:THRESHOLD?,
2–253

TRIGGER:MAIN:PULSE:RUNT:

THRESHOLD:BOTH, 2–254

TRIGGER:MAIN:PULSE:RUNT:

THRESHOLD:HIGH, 2–254

TRIGGER:MAIN:PULSE:RUNT:

THRESHOLD:LOW, 2–255

TRIGGER:MAIN:PULSE:RUNT:WHEN, 2–256

TRIGGER:MAIN:PULSE:RUNT:WIDTH, 2–256

TRIGGER:MAIN:PULSE:SLEWRATE:

THRESHOLD:HIGH, 2–259

TRIGGER:MAIN:PULSE:SLEWRATE:

DELTATIME, 2–257

TRIGGER:MAIN:PULSE:SLEWRATE:POLARITY,
2–258

TRIGGER:MAIN:PULSE:SLEWRATE:
SLEWRATE, 2–258

TRIGGER:MAIN:PULSE:SLEWRATE:

THRESHOLD:BOTH, 2–259

TRIGGER:MAIN:PULSE:SLEWRATE:

THRESHOLD:LOW, 2–260

- TRIGGER:MAIN:PULSE:SLEWRATE:WHEN, 2–261
- TRIGGER:MAIN:PULSE:SOURCE, 2–261
- TRIGGER:MAIN:PULSE:WIDTH?, 2–262
- TRIGGER:MAIN:PULSE:WIDTH:HIGHLIMIT, 2–262
- TRIGGER:MAIN:PULSE:WIDTH:LOWLIMIT, 2–263
- TRIGGER:MAIN:PULSE:WIDTH:POLARITY, 2–263
- TRIGGER:MAIN:PULSE:WIDTH:WHEN, 2–264
- TRIGGER:MAIN:TYPE, 2–265
- TRIGGER:MAIN:VIDEO?, 2–266
- TRIGGER:MAIN:VIDEO:BY, 2–266
- TRIGGER:MAIN:VIDEO:FIELD, 2–267, 2–268
- TRIGGER:MAIN:VIDEO:FIELDTYPE, 2–269
- TRIGGER:MAIN:VIDEO:FLEXFORMAT?, 2–269
- TRIGGER:MAIN:VIDEO:FLEXFORMAT:FIELD, 2–270
- TRIGGER:MAIN:VIDEO:FLEXFORMAT:FRAMERATE, 2–270
- TRIGGER:MAIN:VIDEO:FLEXFORMAT:LINES, 2–271
- TRIGGER:MAIN:VIDEO:FLEXFORMAT:NEG-SYNCWIDTH, 2–272
- TRIGGER:MAIN:VIDEO:FLEXFORMAT:V1STARTTIME, 2–272
- TRIGGER:MAIN:VIDEO:FLEXFORMAT:V1STOPTIME, 2–273
- TRIGGER:MAIN:VIDEO:FLEXFORMAT:V2STARTTIME, 2–274
- TRIGGER:MAIN:VIDEO:FLEXFORMAT:V2STOPTIME, 2–274
- TRIGGER:MAIN:VIDEO:HDTV, 2–275
- TRIGGER:MAIN:VIDEO:HOLDOFF?, 2–276
- TRIGGER:MAIN:VIDEO:HOLDOFF:VALUE, 2–276, 2–277
- TRIGGER:MAIN:VIDEO:LINE, 2–277
- TRIGGER:MAIN:VIDEO:LINES, 2–278
- TRIGGER:MAIN:VIDEO:NTSC, 2–278
- TRIGGER:MAIN:VIDEO:PAL, 2–279
- TRIGGER:MAIN:VIDEO:SCAN, 2–280
- TRIGGER:MAIN:VIDEO:SCANPERIOD, 2–280
- TRIGGER:MAIN:VIDEO:SOURCE, 2–281
- TRIGGER:MAIN:VIDEO:STANDARD, 2–281
- TRIGGER:MAIN:VIDEO:SYNC, 2–282
- TRIGGER:MAIN:VIDEO:SYSTEM, 2–283
- TRIGGER:MAIN:VIDEO:TIME, 2–284
- TRIGGER:STATE?, 2–284
- TRIGGER:DELAY, 2–220
- TRIGGER:DELAY:BY, 2–221
- TRIGGER:DELAY:EDGE?, 2–222
- TRIGGER:DELAY:EDGE:COUPLING, 2–222
- TRIGGER:DELAY:EDGE:SLOPE, 2–223
- TRIGGER:DELAY:EDGE:SOURCE, 2–224
- TRIGGER:DELAY:EVENTS?, 2–224
- TRIGGER:DELAY:EVENTS:COUNT, 2–225
- TRIGGER:DELAY:LEVEL, 2–225
- TRIGGER:DELAY:TIME, 2–226
- TRIGGER:DELAY:TYPE, 2–227
- TRIGGER:MAIN, 2–227
- TRIGGER:MAIN:EDGE?, 2–228
- TRIGGER:MAIN:EDGE:COUPLING, 2–228
- TRIGGER:MAIN:EDGE:SLOPE, 2–229
- TRIGGER:MAIN:EDGE:SOURCE, 2–230
- TRIGGER:MAIN:HOLDOFF?, 2–230
- TRIGGER:MAIN:HOLDOFF:ACTUAL?, 2–231
- TRIGGER:MAIN:HOLDOFF:BY, 2–231
- TRIGGER:MAIN:HOLDOFF:TIME, 2–232
- TRIGGER:MAIN:HOLDOFF:VALUE, 2–233
- TRIGGER:MAIN:LEVEL, 2–233
- TRIGGER:MAIN:LOGIC?, 2–234
- TRIGGER:MAIN:LOGIC:CLASS, 2–234
- TRIGGER:MAIN:LOGIC:FUNCTION, 2–235
- TRIGGER:MAIN:LOGIC:INPUT?, 2–236
- TRIGGER:MAIN:LOGIC:INPUT:CH<x>?, 2–237
- TRIGGER:MAIN:LOGIC:PATTERN: INPUT:CH4?, 2–237
- TRIGGER:MAIN:LOGIC:PATTERN: WHEN, 2–238
- TRIGGER:MAIN:LOGIC:PATTERN: WHEN:LESSLIMIT, 2–239
- TRIGGER:MAIN:LOGIC:PATTERN: WHEN:MORELIMIT, 2–240
- TRIGGER:MAIN:LOGIC:SETHOLD:CLOCK:EDGE, 2–240
- TRIGGER:MAIN:LOGIC:SETHOLD:CLOCK:LEVEL, 2–241
- TRIGGER:MAIN:LOGIC:SETHOLD:CLOCK:SOURCE, 2–242
- TRIGGER:MAIN:LOGIC:SETHOLD:DATA:LEVEL, 2–242
- TRIGGER:MAIN:LOGIC:SETHOLD:DATA:SOURCE, 2–243
- TRIGGER:MAIN:LOGIC:SETHOLD:HOLDTIME, 2–244
- TRIGGER:MAIN:LOGIC:SETHOLD:SETTIME, 2–244
- TRIGGER:MAIN:LOGIC:STATE: INPUT:CH4?, 2–245
- TRIGGER:MAIN:LOGIC:STATE:WHEN, 2–246
- TRIGGER:MAIN:LOGIC:THRESHOLD?, 2–246
- TRIGGER:MAIN:LOGIC:THRESHOLD<x>, 2–247
- TRIGGER:MAIN:LOGIC:WHEN, 2–247
- TRIGGER:MAIN:MODE, 2–248

- TRIGGER:MAIN:PULSE?, 2-248
 TRIGGER:MAIN:PULSE:CLASS, 2-249
 TRIGGER:MAIN:PULSE:GLITCH?, 2-250
 TRIGGER:MAIN:PULSE:GLITCH:FILTER, 2-250
 TRIGGER:MAIN:PULSE:GLITCH:POLARITY,
 2-251
 TRIGGER:MAIN:PULSE:GLITCH:WIDTH, 2-252
 TRIGGER:MAIN:PULSE:RUNT?, 2-252
 TRIGGER:MAIN:PULSE:RUNT:POLARITY, 2-253
 TRIGGER:MAIN:PULSE:RUNT:THRESHOLD?,
 2-253
 TRIGGER:MAIN:PULSE:RUNT:
 THRESHOLD:BOTH, 2-254
 TRIGGER:MAIN:PULSE:RUNT:
 THRESHOLD:HIGH, 2-254
 TRIGGER:MAIN:PULSE:RUNT:THRESHOLD:LOW,
 2-255
 TRIGGER:MAIN:PULSE:RUNT:WHEN, 2-256
 TRIGGER:MAIN:PULSE:RUNT:WIDTH, 2-256
 TRIGGER:MAIN:PULSE:SLEWRATE:DELTATIME,
 2-257
 TRIGGER:MAIN:PULSE:SLEWRATE:POLARITY,
 2-258
 TRIGGER:MAIN:PULSE:SLEWRATE:SLEWRATE?,
 2-258
 TRIGGER:MAIN:PULSE:SLEWRATE:
 THRESHOLD:BOTH, 2-259
 TRIGGER:MAIN:PULSE:SLEWRATE:
 THRESHOLD:HIGH, 2-259
 TRIGGER:MAIN:PULSE:SLEWRATE:
 THRESHOLD:LOW, 2-260
 TRIGGER:MAIN:PULSE:SLEWRATE:WHEN, 2-261
 TRIGGER:MAIN:PULSE:SOURCE, 2-261
 TRIGGER:MAIN:PULSE:WIDTH?, 2-262
 TRIGGER:MAIN:PULSE:WIDTH:HIGHLIMIT,
 2-262
 TRIGGER:MAIN:PULSE:WIDTH:LOWLIMIT, 2-263
 TRIGGER:MAIN:PULSE:WIDTH:POLARITY, 2-263
 TRIGGER:MAIN:PULSE:WIDTH:WHEN, 2-264
 TRIGGER:MAIN:TYPE, 2-265
 TRIGGER:MAIN:VIDEO?, 2-266
 TRIGGER:MAIN:VIDEO:BY, 2-266
 TRIGGER:MAIN:VIDEO:FIELD, 2-267, 2-268
 TRIGGER:MAIN:VIDEO:FIELDTYPE, 2-269
 TRIGGER:MAIN:VIDEO:FLEXFORMAT?, 2-269
 TRIGGER:MAIN:VIDEO:FLEXFORMAT:FIELD,
 2-270
 TRIGGER:MAIN:VIDEO:FLEXFORMAT:
 FRAMERATE, 2-270
 TRIGGER:MAIN:VIDEO:FLEXFORMAT:LINES,
 2-271
 TRIGGER:MAIN:VIDEO:FLEXFORMAT:
 NEGSYNCWIDTH, 2-272
 TRIGGER:MAIN:VIDEO:FLEXFORMAT:
 V1STARTTIME, 2-272
 TRIGGER:MAIN:VIDEO:FLEXFORMAT:
 V1STOPTIME, 2-273
 TRIGGER:MAIN:VIDEO:FLEXFORMAT:
 V2STARTTIME, 2-274
 TRIGGER:MAIN:VIDEO:FLEXFORMAT:
 V2STOPTIME, 2-274
 TRIGGER:MAIN:VIDEO:HDTV, 2-275
 TRIGGER:MAIN:VIDEO:HOLDOFF?, 2-276
 TRIGGER:MAIN:VIDEO:HOLDOFF:VALUE, 2-276,
 2-277
 TRIGGER:MAIN:VIDEO:LINE, 2-277
 TRIGGER:MAIN:VIDEO:LINES, 2-278
 TRIGGER:MAIN:VIDEO:NTSC, 2-278
 TRIGGER:MAIN:VIDEO:PAL, 2-279
 TRIGGER:MAIN:VIDEO:SCAN, 2-280
 TRIGGER:MAIN:VIDEO:SCANPERIOD, 2-280
 TRIGGER:MAIN:VIDEO:SOURCE, 2-281
 TRIGGER:MAIN:VIDEO:STANDARD, 2-281
 TRIGGER:MAIN:VIDEO:SYNC, 2-282
 TRIGGER:MAIN:VIDEO:SYSTEM, 2-283
 TRIGGER:MAIN:VIDEO:TIME, 2-284
 TRIGGER:STATE?, 2-284
 *TST? query, 2-286
- ## U
- UNL, C-2
 Unlisten, C-2
 UNLOCK, 2-286
 UNT, C-2
 Untalk, C-2
- ## V
- VERBOSE, 2-287
 Vertical
 MATH<x>?, 2-166
 MATH<x>:DEFINE, 2-166
 MATH<x>:NUMAVg, 2-168
 MATH<x>:PROcEssing, 2-169
 Vertical bar cursors, 2-79
 Vertical command group, 2-31
 Vertical commands
 CH<x>?, 2-61
 CH<x>:BANDWIDTH, 2-61
 CH<x>:COUPLING, 2-62

CH<x>:IMPEDANCE, 2-63
 CH<x>:OFFSET, 2-64
 CH<x>:POSITION, 2-65
 CH<x>:PROBE?, 2-66
 CH<x>:SCALE, 2-66
 CH<x>:VOLTS, 2-67
 SELECT?, 2-214
 SELECT:<wfm>, 2-215
 SELECT:CONTROL?, 2-215
 Video trigger, 2-265, 2-266, 2-267, 2-268, 2-269,
 2-270, 2-271, 2-272, 2-273, 2-274, 2-275,
 2-276, 2-277, 2-278, 2-279, 2-280, 2-281,
 2-282, 2-283, 2-284

W

*WAI, 2-287
 Wait for operation complete, 2-287
 Waveform, command mnemonic, 2-7
 Waveform command group, 2-32
 Waveform commands
 CURVE, 2-85
 DATA, 2-87
 DATA:DESTINATION, 2-87
 DATA:ENCDG, 2-88
 DATA:SOURCE, 2-90
 DATA:START, 2-91
 DATA:STOP, 2-92
 DATA:TARGET, 2-92
 DATA:WIDTH, 2-93
 WAVFRM?, 2-288
 WFMPRE?, 2-288
 WFMPRE:<wfm>?, 2-296
 WFMPRE:<wfm>:NR_PT, 2-296
 WFMPRE:<wfm>:PT_FMT, 2-297
 WFMPRE:<wfm>:PT_OFF, 2-298
 WFMPRE:<wfm>:WFID, 2-298
 WFMPRE:<wfm>:XINCR, 2-299
 WFMPRE:<wfm>:XUNIT, 2-299
 WFMPRE:<wfm>:YMULT, 2-300
 WFMPRE:<wfm>:YOFF, 2-301
 WFMPRE:<wfm>:YUNIT, 2-301
 WFMPRE:<wfm>:YZERO, 2-302
 WFMPRE:BIT_NR, 2-289
 WFMPRE:BN_FMT, 2-289
 WFMPRE:BYT_NR, 2-290
 WFMPRE:BYT_OR, 2-291
 WFMPRE:CRVCHK, 2-295
 WFMPRE:ENCDG, 2-292
 WFMPRE:NR_PT, 2-295
 WFMPRE:PT_FMT, 2-292
 WFMPRE:PT_OFF, 2-293
 WFMPRE:WFID, 2-295
 WFMPRE:XINCR, 2-294
 WFMPRE:XMULT, 2-295
 WFMPRE:XOFF, 2-295
 WFMPRE:XUNIT, 2-295
 WFMPRE:XZERO, 2-295
 WFMPRE:YMULT, 2-294
 WFMPRE:YOFF, 2-294
 WFMPRE:YUNIT, 2-295
 WFMPRE:YZERO, 2-295
 WFMPRE:ZMULT, 2-295
 WFMPRE:ZOFF, 2-295
 WFMPRE:ZUNIT, 2-295
 WFMPRE:ZZERO, 2-295
 Width trigger, 2-249, 2-262, 2-263, 2-264

Z

ZOOM, 2–302

Zoom command group, 2–37

Zoom commands

 ZOOM, 2–302

 ZOOM:DUAL, 2–303

 ZOOM:DUAL:OFFSET, 2–303

 ZOOM:GRATICULE, 2–304

 ZOOM:HORIZONTAL:LOCK, 2–305

 ZOOM:HORIZONTAL:POSITION, 2–305

 ZOOM:HORIZONTAL:SCALE, 2–306

 ZOOM:STATE, 2–307

 ZOOM:VERTICAL:POSITION, 2–308

 ZOOM:VERTICAL:SCALE, 2–308

ZOOM GRATICULE, 2–304

ZOOM:DUAL, 2–303

ZOOM:DUAL:OFFSET, 2–303

ZOOM:HORIZONTAL:LOCK, 2–305

ZOOM:HORIZONTAL:POSITION, 2–305

ZOOM:HORIZONTAL:SCALE, 2–306

ZOOM:STATE, 2–307

ZOOM:VERTICAL:POSITION, 2–308

ZOOM:VERTICAL:SCALE, 2–308

