



# DIAGNOSTICS OF RF BREAKDOWNS IN HIGH-GRADIENT ACCELERATING STRUCTURES

A. Palaia, Uppsala University, Sweden

V. Dolgashev, J. Lewandowski, S. Weathersby, SLAC National Accelerator Laboratory, CA, USA

The resonant ring at ASTA allows high power structure testing in a two-arm wave guide loop meant to recirculate the field such that it constructively interferes with itself increasing the power level in the structure at every turn.

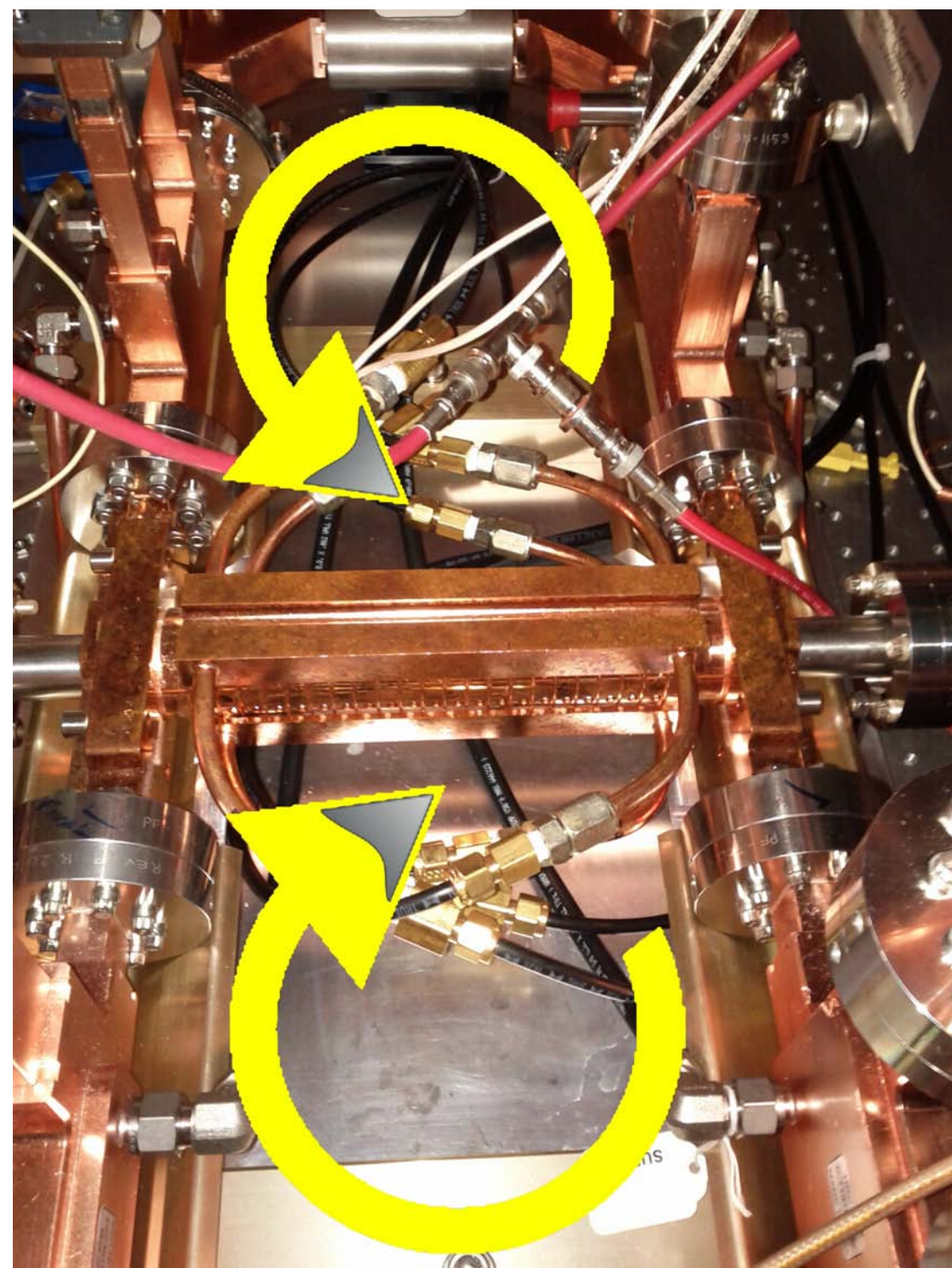

The T18\_vg2.6\_disk is a  $2\pi/3$  travelling wave X-band structure based on CLIC requirements (100 MV/m). It is the result of the CERN-SLAC-KEK collaboration.

The diagnostics built for the resonant ring allows power level and field measurements as well as the measurement of currents emitted during and after a breakdown.

RF signal processing (IQ demodulation and envelope detection) is numerically realized off-line.

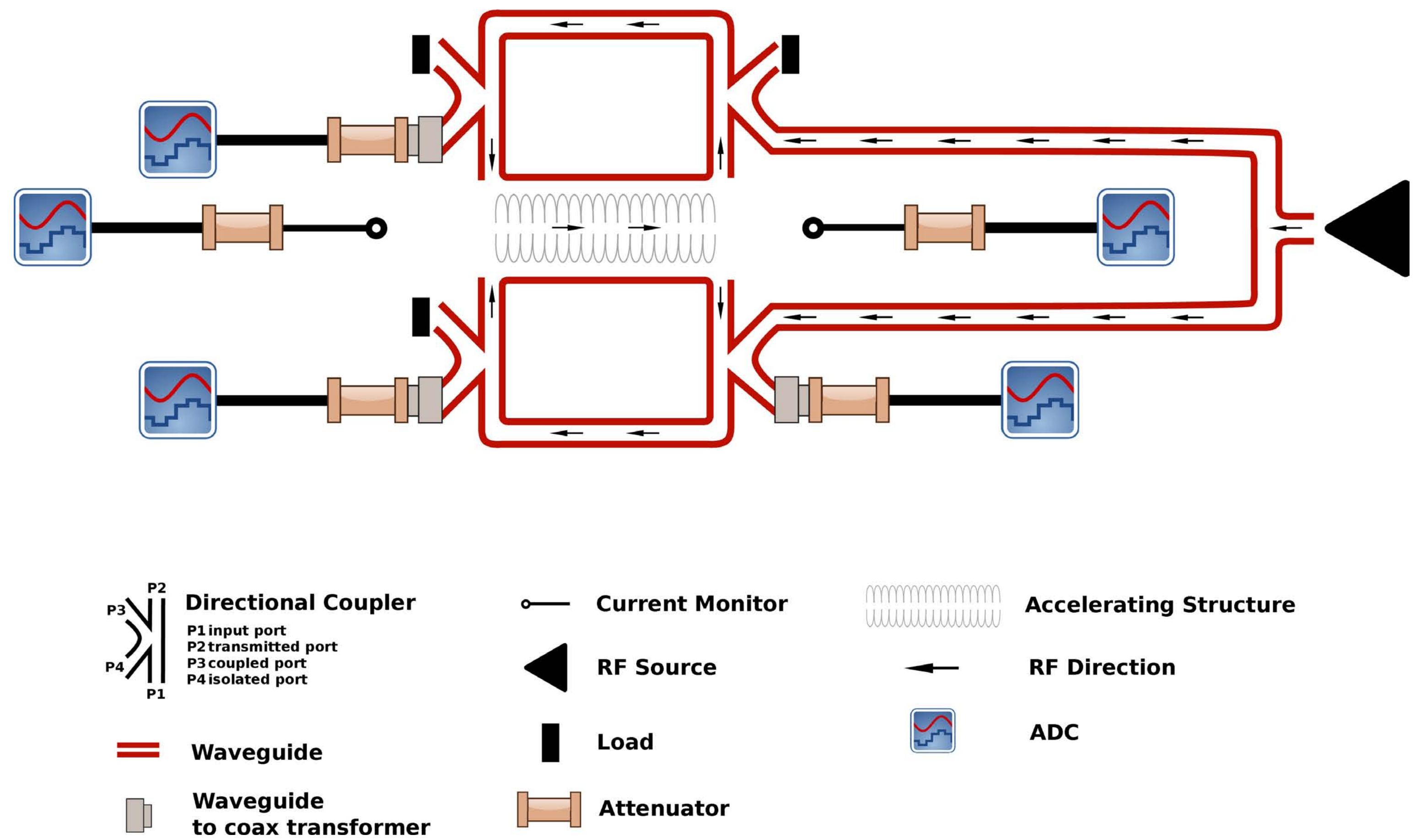

T18 structure tested at ASTA resonant ring at **SLAC**  
NATIONAL ACCELERATOR LABORATORY

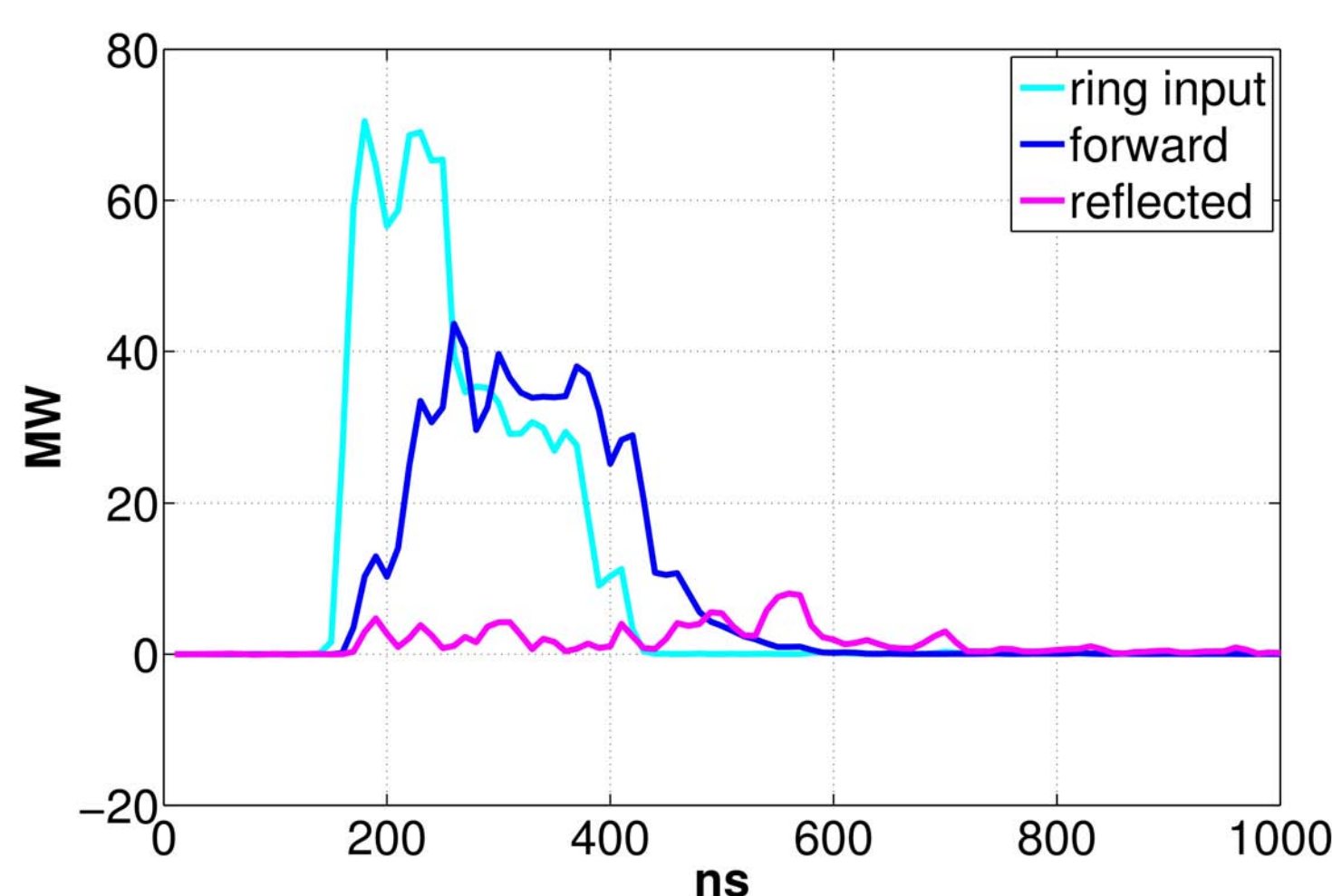

power level measurements

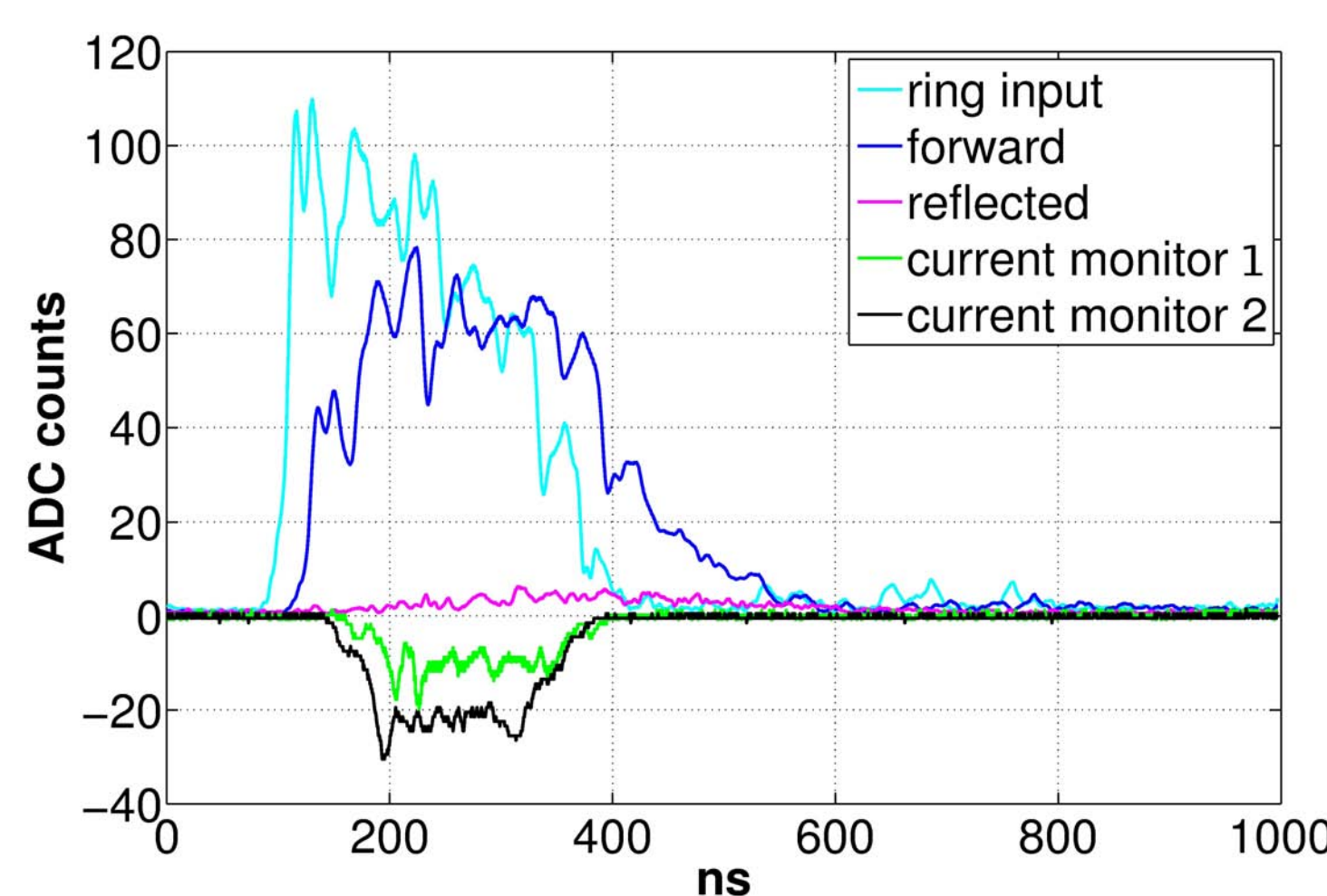

field and current measurements before (left) and during (right) a breakdown

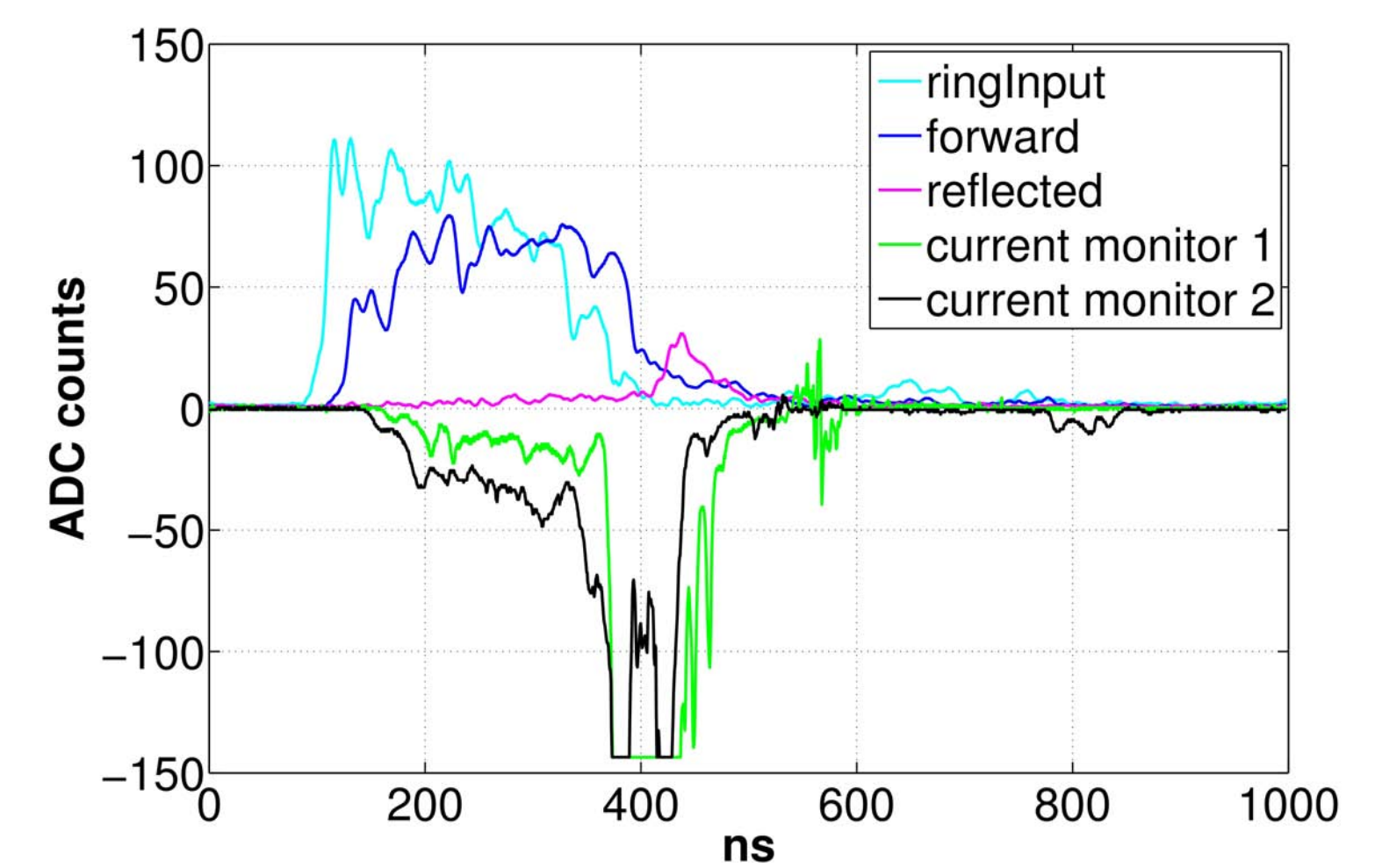

## Estimation of the breakdown locations in the structure using phase and time information from RF measurements

The phase difference between forward and reflected field tells us the breakdown location in the structure short of an integer number of wavelengths.

Time information given by the instant at which the reflected field appears and the instant at which the forward field measurement shows missing power together with phase information uniquely determines the breakdown location in the structure.

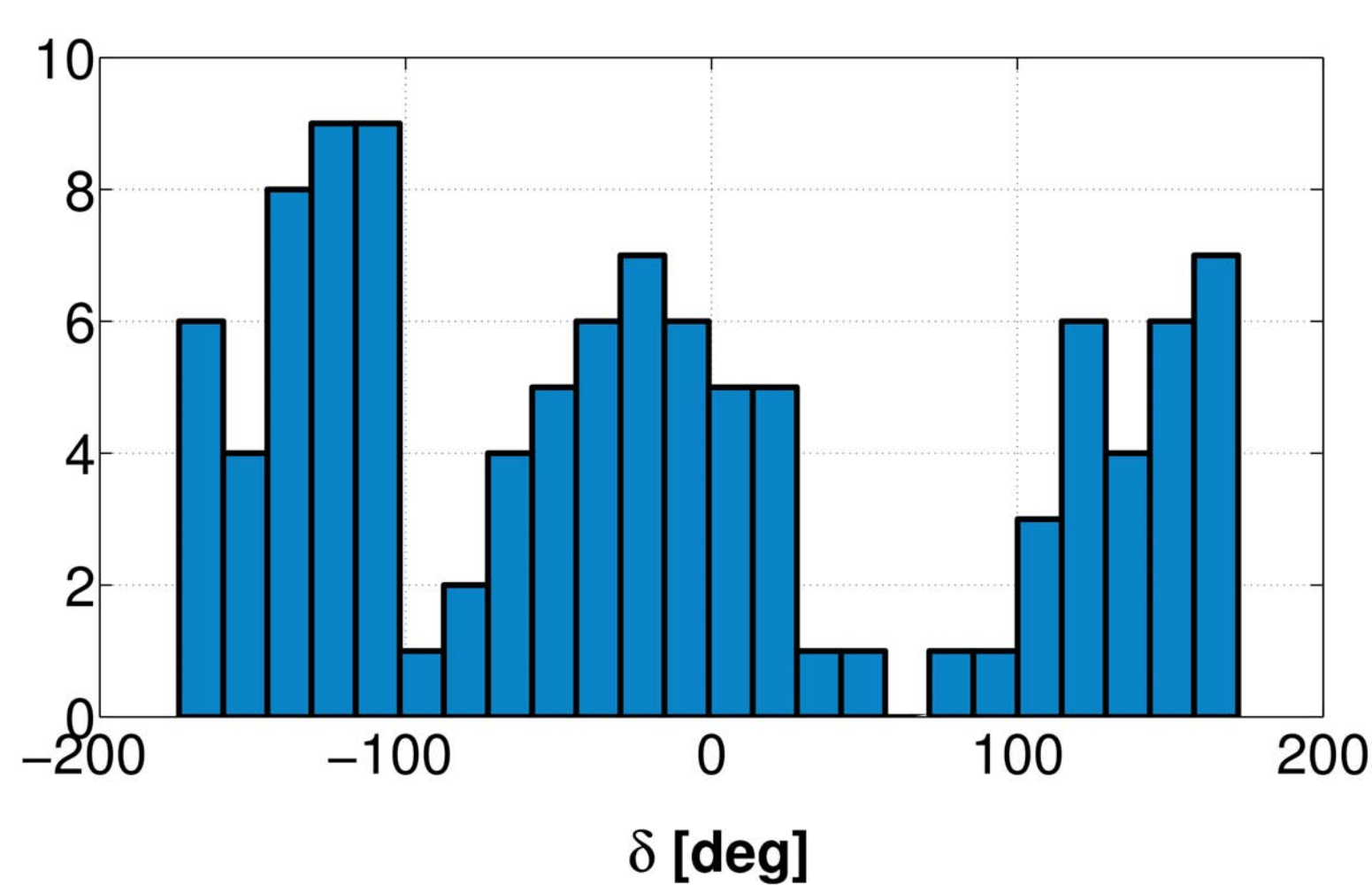

phase difference between forward and reflected RF

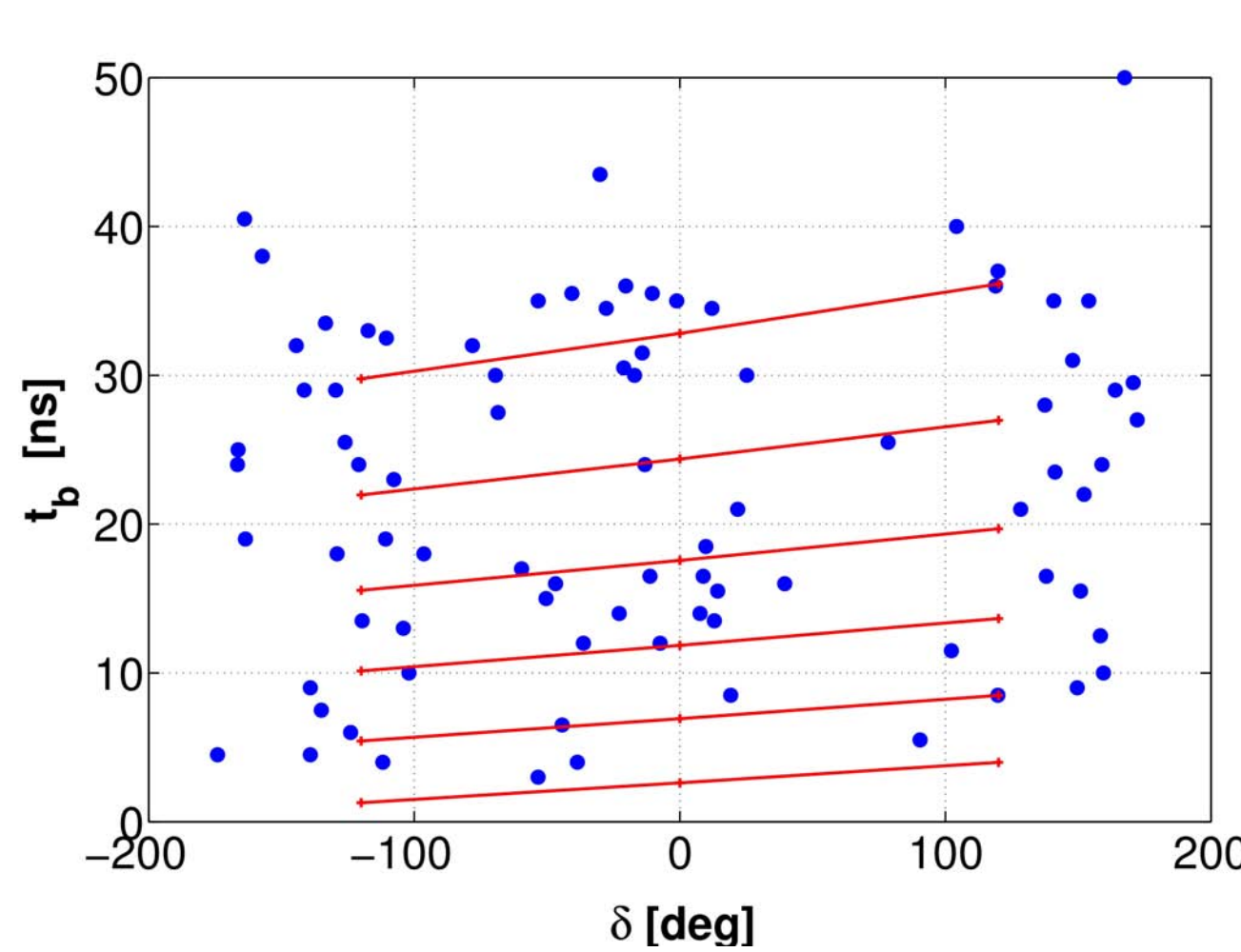

phase and time information for each breakdown event compared with the position of each cell (red crosses)

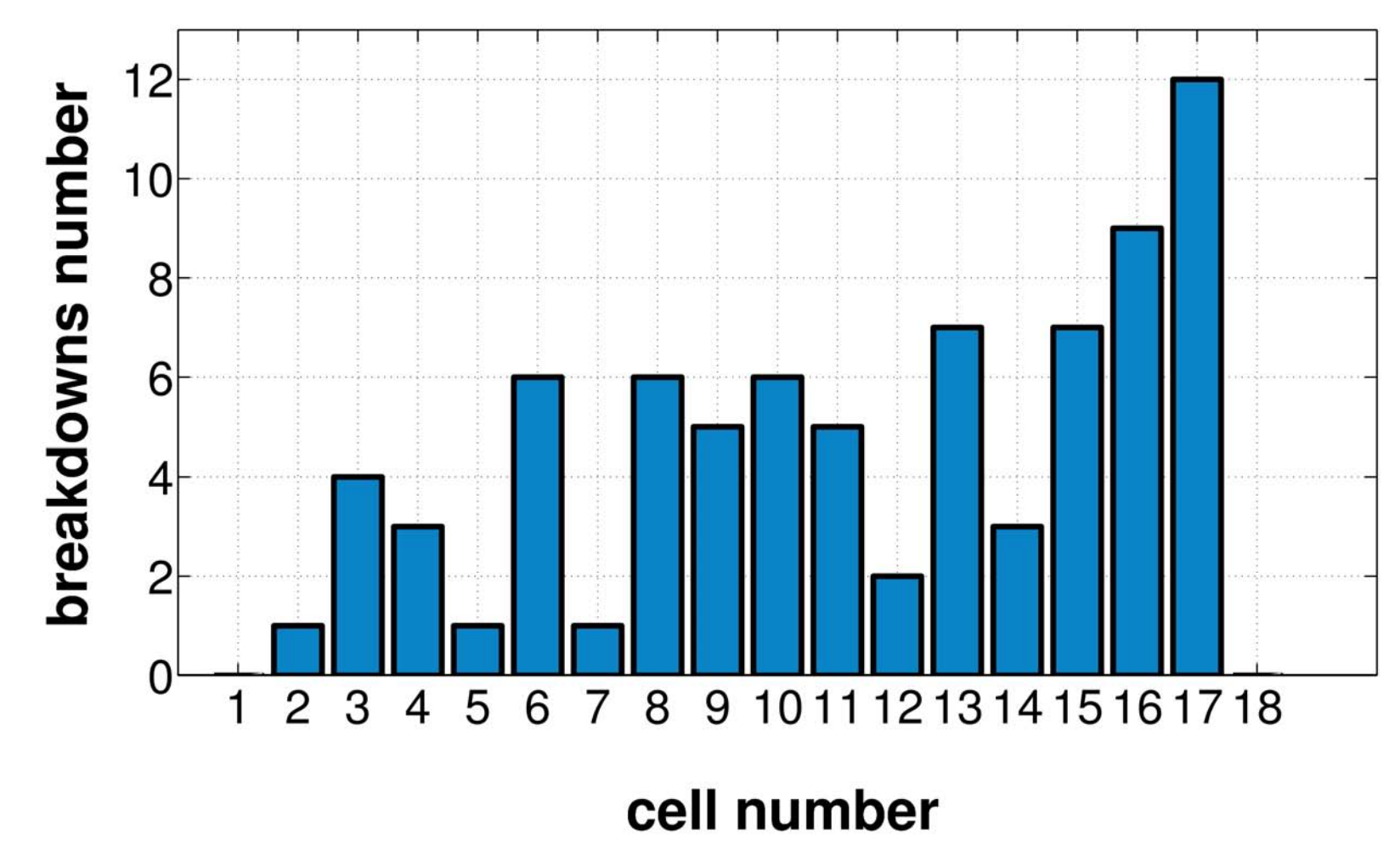

breakdowns distribution along the structure

## Can we say something about the properties of the object reflecting RF during a breakdown?

The RF reflection measured during a breakdown can be thought as the reflection due to a mismatched load of normalized impedance  $z_L$  in a microwave circuit.

Assuming that the object responsible for the reflection is characterized by the complex permittivity  $\epsilon$  and by a unitary magnetic permeability,

$$z_L = \sqrt{\epsilon} = (1-\Gamma) / (1+\Gamma)$$

where  $\Gamma$  is the reflection coefficient.

Exploring the possibility that the RF reflection is caused by a plasma (non-collisional and quasi-neutral) with permittivity  $\epsilon$  grown in the structure during the breakdown, suggests that its density would be about  $5 \cdot 10^{15}$  electrons per cubic centimetre.

